

Cree Edge™ Series

LED Area/Flood Luminaire

Product Description

The Cree Edge™ Series has a slim, low profile design. Its rugged cast aluminum housing minimizes wind load requirements and features an integral, weathertight LED driver compartment and high performance aluminum heat sinks. Various mounting choices: Adjustable Arm, Direct Arm, Direct Arm Long, or Side Arm (details on page 2). Includes a leaf/debris guard.

Applications: Parking lots, walkways, campuses, car dealerships, office complexes, and internal roadways

Performance Summary

Patented NanoOptic® Product Technology

Assembled in the U.S.A. of U.S. and imported parts

CRI: Minimum 70 CRI

CCT: 4000K (+/- 300K), 5700K (+/- 500K) standard

Limited Warranty*: 10 years on luminaire/10 years on Colorfast DeltaGuard® finish

*See <http://lighting.cree.com/warranty> for warranty terms

Accessories

Field-Installed	
Bird Spikes XA-BRDSPK Hand-Held Remote XA-SENSREM - For successful implementation of the programmable multi-level option, a minimum of one hand-held remote is required	Backlight Control Shields XA-20BLS-4 - Four-pack - Unpainted stainless steel

Ordering Information

Example: ARE-EDG-2M-AA-12-E-UL-SV-350

Product	Optic	Mounting*	LED Count (x10)	Series	Voltage	Color Options	Drive Current	Options
ARE-EDG	2M Type II Medium 2MB Type II Medium w/BLS 2MP Type II Medium w/Partial BLS 3M Type III Medium 3MB Type III Medium w/BLS 3MP Type III Medium w/Partial BLS 4M Type IV Medium 4MB Type IV Medium w/BLS	AA Adjustable Arm DA Direct Arm DL Direct Long Arm	02	E	UL Universal 120-277V	BK Black BZ Bronze SV Silver WH White	350 350mA 525 525mA 700 700mA - Available with 20-60 LEDs	DIM 0-10V Dimming - Control by others - Refer to Dimming spec sheet for details - Can't exceed specified drive current F Fuse - Refer to ML spec sheet for availability with ML options - Available with UL voltage only - Available for U.S. applications only - When code dictates fusing, use time delay fuse HL Hi/Low (Dual Circuit Input) - Refer to HL spec sheet for details - Sensor not included ML Multi-Level - Refer to ML spec sheet for details - Intended for downlight applications at 0° tilt P Photocell - Refer to ML spec sheet for availability with ML options - Available with UL voltage only
			04					
			06					
			08					
			10					
			12					
FLD-EDG	25 25° Flood 40 40° Flood 70 70° Flood SN Sign N6 NEMA® 6	AA Adjustable Arm SA Side Arm - Available with 20-60 LEDs	14	E	UL Universal 120-277V	BK Black BZ Bronze SV Silver WH White	350 350mA 525 525mA 700 700mA - Available with 20-60 LEDs	PML Programmable Multi-Level, 20-40' Mounting Height - Refer to PML spec sheet for details - Intended for downlight applications at 0° tilt PML2 Programmable Multi-Level, 10-30' Mounting Height - Refer to PML spec sheet for details - Intended for downlight applications at 0° tilt R NEMA® Photocell Receptacle - Intended for downlight applications with maximum 45° tilt - Photocell by others - Refer to ML spec sheet for availability with ML options 40K 4000K Color Temperature - Minimum 70 CRI - Color temperature per luminaire
			16					
			14					
			16					

* Reference EPA and pole configuration suitability data beginning on page 19

DA Mount

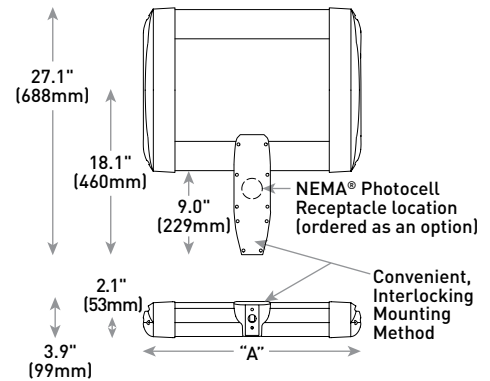

LED Count (x10)	Dim. "A"	Weight
02	12.1" (306mm)	21 lbs. (10kg)
04	12.1" (306mm)	24 lbs. (11kg)
06	14.1" (357mm)	27 lbs. (12kg)
08	16.1" (408mm)	28 lbs. (13kg)
10	18.1" (459mm)	32 lbs. (15kg)
12	20.1" (510mm)	34 lbs. (15kg)
14	22.1" (560mm)	37 lbs. (17kg)
16	24.1" (611mm)	41 lbs. (19kg)

AA/DL/SA Mount - see page 22 for weight & dimensions



US: lighting.cree.com

T (800) 236-6800 F (262) 504-5415

Rev. Date: V7 R1 10/02/2018

Canada: www.cree.com/canada



T (800) 473-1234 F (800) 890-7507

Product Specifications

CONSTRUCTION & MATERIALS

- Slim, low profile, minimizing wind load requirements
- Luminaire sides are rugged die cast aluminum with integral, weathertight LED driver compartment and high performance heat sinks
- DA and DL mount utilizes convenient interlocking mounting method. Mounting is rugged die cast aluminum, mounts to 3-6" (76-152mm) square or round pole and secures to pole with 5/16-18 UNC bolts spaced on 2" (51mm) centers
- AA and SA mounts are rugged die cast aluminum and mount to 2" (51mm) IP, 2.375" (60mm) O.D. tenons
- Includes leaf/debris guard
- Exclusive Colorfast DeltaGuard® finish features an E-Coat epoxy primer with an ultra-durable powder topcoat, providing excellent resistance to corrosion, ultraviolet degradation and abrasion. Black, bronze, silver, and white are available
- **Weight:** See Dimensions and Weight Charts on pages 1 and 22

ELECTRICAL SYSTEM

- **Input Voltage:** 120-277V or 347-480V, 50/60Hz, Class 1 drivers
- **Power Factor:** > 0.9 at full load
- **Total Harmonic Distortion:** < 20% at full load
- DA and DL mounts designed with integral weathertight electrical box with terminal strips (12Ga-20Ga) for easy power hookup
- Integral 10kV surge suppression protection standard
- When code dictates fusing, a slow blow fuse or type C/D breaker should be used to address inrush current
- **Maximum 10V Source Current:** 20 LED (350mA): 10mA; 20 LED (525 & 700mA) and 40-80 LED: 0.15mA; 100-160 LED: 0.30mA

REGULATORY & VOLUNTARY QUALIFICATIONS

- cULus Listed
- Suitable for wet locations
- Enclosure rated IP66 per IEC 60529 when ordered without P or R options
- Consult factory for CE Certified products
- Certified to ANSI C136.31-2001, 3G bridge and overpass vibration standards when ordered with AA, DA and DL mounts
- 10kV surge suppression protection tested in accordance with IEEE/ANSI C62.41.2
- Meets FCC Part 15, Subpart B, Class A standards for conducted and radiated emissions
- Luminaire and finish endurance tested to withstand 5,000 hours of elevated ambient salt fog conditions as defined in ASTM Standard B 117
- DLC qualified with select SKUs. Refer to <https://www.designlights.org/search/> for most current information
- Meets Buy American requirements within ARRA
- **CA RESIDENTS WARNING:** Cancer and Reproductive Harm – www.p65warnings.ca.gov

Electrical Data*							
LED Count (x10)	System Watts 120-480V	Total Current (A)					
		120V	208V	240V	277V	347V	480V
350mA							
02	25	0.21	0.13	0.11	0.10	0.08	0.07
04	46	0.36	0.23	0.21	0.20	0.15	0.12
06	66	0.52	0.31	0.28	0.26	0.20	0.15
08	90	0.75	0.44	0.38	0.34	0.26	0.20
10	110	0.92	0.53	0.47	0.41	0.32	0.24
12	130	1.10	0.63	0.55	0.48	0.38	0.28
14	158	1.32	0.77	0.68	0.62	0.47	0.35
16	179	1.49	0.87	0.77	0.68	0.53	0.39
525mA							
02	37	0.30	0.19	0.17	0.16	0.12	0.10
04	70	0.58	0.34	0.31	0.28	0.21	0.16
06	101	0.84	0.49	0.43	0.38	0.30	0.22
08	133	1.13	0.66	0.58	0.51	0.39	0.28
10	171	1.43	0.83	0.74	0.66	0.50	0.38
12	202	1.69	0.98	0.86	0.77	0.59	0.44
14	232	1.94	1.12	0.98	0.87	0.68	0.50
16	263	2.21	1.27	1.11	0.97	0.77	0.56
700mA							
02	50	0.41	0.25	0.22	0.20	0.15	0.12
04	93	0.78	0.46	0.40	0.36	0.27	0.20
06	134	1.14	0.65	0.57	0.50	0.39	0.29

* Electrical data at 25°C (77°F). Actual wattage may differ by +/- 10% when operating between 120-480V +/- 10%

Cree Edge™ Series Ambient Adjusted Lumen Maintenance ¹					
Ambient	Initial LMF	25K hr Projected ² LMF	50K hr Projected ² LMF	75K hr Calculated ³ LMF	100K hr Calculated ³ LMF
5°C (41°F)	1.04	1.01	0.99	0.98	0.96
10°C (50°F)	1.03	1.00	0.98	0.97	0.95
15°C (59°F)	1.02	0.99	0.97	0.96	0.94
20°C (68°F)	1.01	0.98	0.96	0.95	0.93
25°C (77°F)	1.00	0.97	0.95	0.94	0.92

¹ Lumen maintenance values at 25°C are calculated per TM-21 based on LM-80 data and in-situ luminaire testing.

Luminaire ambient temperature factors (LATF) have been applied to all lumen maintenance factors

² In accordance with IESNA TM-21-11, Projected Values represent interpolated value based on time durations that are within six times

(6X) the IESNA LM-80-08 total test duration (in hours) for the device under testing (DUT) i.e. the packaged LED chip

³ In accordance with IESNA TM-21-11, Calculated Values represent time durations that exceed six times (6X) the IESNA LM-80-08 total test duration (in hours) for the device under testing (DUT) i.e. the packaged LED chip



Photometry

All published luminaire photometric testing performed to IESNA LM-79-08 standards by a NVLAP accredited laboratory. To obtain an IES file specific to your project consult: <http://lighting.cree.com/products/outdoor/area/cree-edge-series-1>

2M

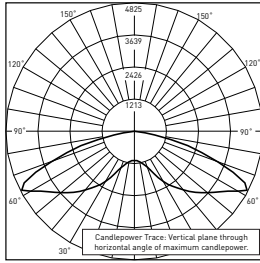

RESTL Test Report #: PL10270-004B
 ARE-EDG-2M-**-06-E-UL-525-40K
 Initial Delivered Lumens: 10,053

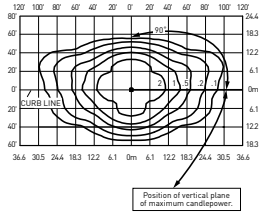

ARE-EDG-2M-**-10-E-UL-525-40K
 Mounting Height: 25' (7.6m) A.F.G.
 Initial Delivered Lumens: 17,504
 Initial FC at grade

Type II Medium Distribution				
LED Count (x10)	4000K		5700K	
	Initial Delivered Lumens*	BUG Ratings** Per TM-15-11	Initial Delivered Lumens*	BUG Ratings** Per TM-15-11
350mA				
02	2,501	B1 U0 G1	2,551	B1 U0 G1
04	5,003	B1 U0 G1	5,102	B1 U0 G1
06	7,418	B2 U0 G2	7,565	B2 U0 G2
08	9,891	B2 U0 G2	10,087	B2 U0 G2
10	12,334	B2 U0 G2	12,578	B2 U0 G2
12	14,801	B3 U0 G3	15,094	B3 U0 G3
14	17,158	B3 U0 G3	17,498	B3 U0 G3
16	19,609	B3 U0 G3	19,998	B3 U0 G3
525mA				
02	3,550	B1 U0 G1	3,624	B1 U0 G1
04	7,099	B2 U0 G2	7,248	B2 U0 G2
06	10,527	B2 U0 G2	10,748	B2 U0 G2
08	14,037	B3 U0 G3	14,331	B3 U0 G3
10	17,504	B3 U0 G3	17,870	B3 U0 G3
12	21,004	B3 U0 G3	21,444	B3 U0 G3
14	24,350	B3 U0 G3	24,860	B3 U0 G3
16	27,828	B4 U0 G3	28,411	B4 U0 G3
700mA				
02	4,189	B1 U0 G1	4,275	B1 U0 G1
04	8,379	B2 U0 G2	8,549	B2 U0 G2
06	12,425	B2 U0 G2	12,678	B2 U0 G2

* Initial delivered lumens at 25°C (77°F). Actual production yield may vary between -10 and +10% of initial delivered lumens

** For more information on the IES BUG (Backlight-Uplight-Glare) Rating visit: <https://www.ies.org/wp-content/uploads/2017/03/TM-15-11BUGRatingsAddendum.pdf>

Photometry

All published luminaire photometric testing performed to IESNA LM-79-08 standards by a NVLAP accredited laboratory. To obtain an IES file specific to your project consult: <http://lighting.cree.com/products/outdoor/area/cree-edge-series-1>

2MB

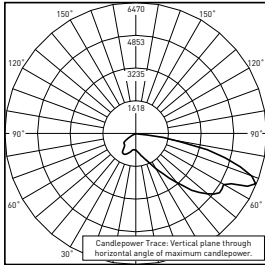

RESTL Test Report #: PL10023-003B
ARE-EDG-2MB--06-E-UL-525-40K**
Initial Delivered Lumens: 7,784

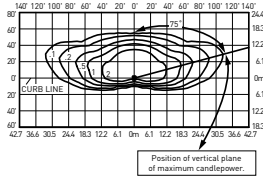

ARE-EDG-2MB--10-E-UL-525-40K**
Mounting Height: 25' (7.6m) A.F.G.
Initial Delivered Lumens: 13,185
Initial FC at grade

Type II Medium Distribution w/BLS				
LED Count (x10)	4000K		5700K	
	Initial Delivered Lumens*	BUG Ratings** Per TM-15-11	Initial Delivered Lumens*	BUG Ratings** Per TM-15-11
350mA				
02	1,884	B0 U0 G1	1,921	B0 U0 G1
04	3,768	B1 U0 G1	3,843	B1 U0 G1
06	5,588	B1 U0 G1	5,698	B1 U0 G1
08	7,450	B1 U0 G2	7,598	B1 U0 G2
10	9,291	B1 U0 G2	9,475	B1 U0 G2
12	11,149	B1 U0 G2	11,370	B1 U0 G2
14	12,924	B1 U0 G2	13,181	B1 U0 G2
16	14,771	B1 U0 G2	15,063	B1 U0 G2
525mA				
02	2,674	B0 U0 G1	2,730	B0 U0 G1
04	5,348	B1 U0 G1	5,460	B1 U0 G1
06	7,930	B1 U0 G2	8,096	B1 U0 G2
08	10,573	B1 U0 G2	10,794	B1 U0 G2
10	13,185	B1 U0 G2	13,461	B1 U0 G2
12	15,821	B2 U0 G2	16,153	B2 U0 G3
14	18,341	B2 U0 G3	18,726	B2 U0 G3
16	20,962	B2 U0 G3	21,401	B2 U0 G3
700mA				
02	3,156	B0 U0 G1	3,220	B0 U0 G1
04	6,311	B1 U0 G1	6,440	B1 U0 G1
06	9,359	B1 U0 G2	9,549	B1 U0 G2

* Initial delivered lumens at 25°C (77°F). Actual production yield may vary between -10 and +10% of initial delivered lumens

** For more information on the IES BUG (Backlight-Uplight-Glare) Rating visit: <https://www.ies.org/wp-content/uploads/2017/03/TM-15-11BUGRatingsAddendum.pdf>

Photometry

All published luminaire photometric testing performed to IESNA LM-79-08 standards by a NVLAP accredited laboratory. To obtain an IES file specific to your project consult: <http://lighting.cree.com/products/outdoor/area/cree-edge-series-1>

2MP

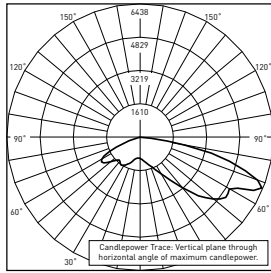

RESTL Test Report #: PL10097-001B
ARE-EDG-2MP--06-E-UL-525-40K**
Initial Delivered Lumens: 9,149

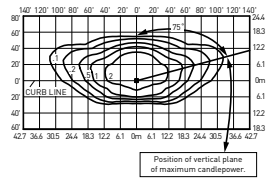

ARE-EDG-2MP--10-E-UL-525-40K**
Mounting Height: 25' (7.6m) A.F.G.
Initial Delivered Lumens: 15,458
Initial FC at grade

Type II Medium Distribution w/Partial BLS				
LED Count (x10)	4000K		5700K	
	Initial Delivered Lumens*	BUG Ratings** Per TM-15-11	Initial Delivered Lumens*	BUG Ratings** Per TM-15-11
350mA				
02	2,209	B1 U0 G1	2,253	B1 U0 G1
04	4,418	B1 U0 G1	4,505	B1 U0 G1
06	6,551	B2 U0 G1	6,681	B2 U0 G1
08	8,735	B2 U0 G2	8,908	B2 U0 G2
10	10,892	B2 U0 G2	11,108	B2 U0 G2
12	13,071	B2 U0 G2	13,330	B2 U0 G2
14	15,153	B2 U0 G2	15,453	B2 U0 G3
16	17,317	B3 U0 G3	17,661	B3 U0 G3
525mA				
02	3,135	B1 U0 G1	3,200	B1 U0 G1
04	6,270	B1 U0 G1	6,401	B2 U0 G1
06	9,297	B2 U0 G2	9,492	B2 U0 G2
08	12,396	B2 U0 G2	12,656	B2 U0 G2
10	15,458	B2 U0 G3	15,782	B2 U0 G3
12	18,549	B3 U0 G3	18,938	B3 U0 G3
14	21,504	B3 U0 G3	21,954	B3 U0 G3
16	24,576	B3 U0 G3	25,091	B3 U0 G3
700mA				
02	3,700	B1 U0 G1	3,775	B1 U0 G1
04	7,400	B2 U0 G2	7,550	B2 U0 G2
06	10,973	B2 U0 G2	11,196	B2 U0 G2

* Initial delivered lumens at 25°C (77°F). Actual production yield may vary between -10 and +10% of initial delivered lumens

** For more information on the IES BUG (Backlight-Uplight-Glare) Rating visit: <https://www.ies.org/wp-content/uploads/2017/03/TM-15-11BUGRatingsAddendum.pdf>



Photometry

All published luminaire photometric testing performed to IESNA LM-79-08 standards by a NVLAP accredited laboratory. To obtain an IES file specific to your project consult: <http://lighting.cree.com/products/outdoor/area/cree-edge-series-1>

3M

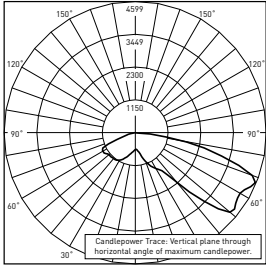

RESTL Test Report #: PL09405-001A
ARE-EDG-3M--06-E-UL-525-40K**
Initial Delivered Lumens: 9,460

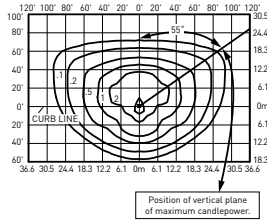

ARE-EDG-3M--10-E-UL-525-40K**
Mounting Height: 25' (7.6m) A.F.G.
Initial Delivered Lumens: 16,594
Initial FC at grade

Type III Medium Distribution				
LED Count (x10)	4000K		5700K	
	Initial Delivered Lumens*	BUG Ratings** Per TM-15-11	Initial Delivered Lumens*	BUG Ratings** Per TM-15-11
350mA				
02	2,371	B1 U0 G1	2,418	B1 U0 G1
04	4,743	B1 U0 G1	4,837	B1 U0 G1
06	7,033	B2 U0 G2	7,172	B2 U0 G2
08	9,377	B2 U0 G2	9,563	B2 U0 G2
10	11,693	B3 U0 G3	11,925	B3 U0 G3
12	14,032	B3 U0 G3	14,310	B3 U0 G3
14	16,267	B3 U0 G3	16,589	B3 U0 G3
16	18,591	B3 U0 G3	18,959	B3 U0 G3
525mA				
02	3,365	B1 U0 G1	3,436	B1 U0 G1
04	6,731	B2 U0 G2	6,872	B2 U0 G2
06	9,981	B3 U0 G3	10,190	B3 U0 G3
08	13,307	B3 U0 G3	13,586	B3 U0 G3
10	16,594	B3 U0 G3	16,942	B3 U0 G3
12	19,913	B3 U0 G3	20,330	B3 U0 G3
14	23,085	B3 U0 G3	23,569	B3 U0 G3
16	26,383	B4 U0 G4	26,936	B4 U0 G4
700mA				
02	3,972	B1 U0 G1	4,053	B1 U0 G1
04	7,944	B2 U0 G2	8,105	B2 U0 G2
06	11,779	B3 U0 G3	12,019	B3 U0 G3

* Initial delivered lumens at 25°C (77°F). Actual production yield may vary between -10 and +10% of initial delivered lumens

** For more information on the IES BUG (Backlight-Uplight-Glare) Rating visit: <https://www.ies.org/wp-content/uploads/2017/03/TM-15-11BUGRatingsAddendum.pdf>

Photometry

All published luminaire photometric testing performed to IESNA LM-79-08 standards by a NVLAP accredited laboratory. To obtain an IES file specific to your project consult: <http://lighting.cree.com/products/outdoor/area/cree-edge-series-1>

3MB

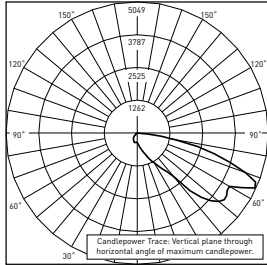

RESTL Test Report #: PL10023-001B
 ARE-EDG-3MB-**-06-E-UL-525-40K
 Initial Delivered Lumens: 7,602

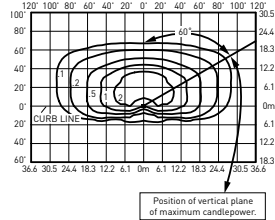

ARE-EDG-3MB-**-10-E-UL-525-40K
 Mounting Height: 25' (7.6m) A.F.G.
 Initial Delivered Lumens: 12,275
 Initial FC at grade

Type III Medium Distribution w/BLS				
LED Count (x10)	4000K		5700K	
	Initial Delivered Lumens*	BUG Ratings** Per TM-15-11	Initial Delivered Lumens*	BUG Ratings** Per TM-15-11
350mA				
02	1,754	B0 U0 G1	1,789	B0 U0 G1
04	3,508	B1 U0 G1	3,578	B1 U0 G1
06	5,202	B1 U0 G2	5,305	B1 U0 G2
08	6,936	B1 U0 G2	7,074	B1 U0 G2
10	8,650	B1 U0 G2	8,821	B1 U0 G2
12	10,380	B1 U0 G3	10,585	B1 U0 G3
14	12,033	B1 U0 G3	12,272	B1 U0 G3
16	13,752	B2 U0 G3	14,025	B2 U0 G3
525mA				
02	2,489	B0 U0 G1	2,542	B0 U0 G1
04	4,979	B1 U0 G2	5,083	B1 U0 G2
06	7,383	B1 U0 G2	7,538	B1 U0 G2
08	9,844	B1 U0 G2	10,050	B1 U0 G3
10	12,275	B1 U0 G3	12,532	B1 U0 G3
12	14,730	B2 U0 G3	15,039	B2 U0 G3
14	17,077	B2 U0 G3	17,434	B2 U0 G3
16	19,516	B2 U0 G3	19,925	B2 U0 G3
700mA				
02	2,938	B1 U0 G1	2,998	B1 U0 G1
04	5,876	B1 U0 G2	5,996	B1 U0 G2
06	8,714	B1 U0 G2	8,891	B1 U0 G2

* Initial delivered lumens at 25°C (77°F). Actual production yield may vary between -10 and +10% of initial delivered lumens

** For more information on the IES BUG (Backlight-Uplight-Glare) Rating visit: <https://www.ies.org/wp-content/uploads/2017/03/TM-15-11BUGRatingsAddendum.pdf>



Photometry

All published luminaire photometric testing performed to IESNA LM-79-08 standards by a NVLAP accredited laboratory. To obtain an IES file specific to your project consult: <http://lighting.cree.com/products/outdoor/area/cree-edge-series-1>

3MP

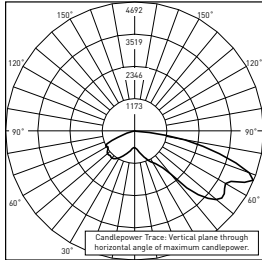

REStL Test Report #: PL10097-002B
ARE-EDG-3MP--06-E-UL-525-40K**
Initial Delivered Lumens: 8,670

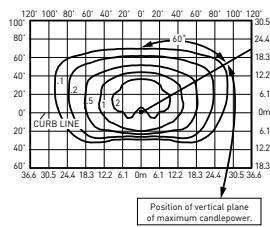

ARE-EDG-3MP--10-E-UL-525-40K**
Mounting Height: 25' (7.6m) A.F.G.
Initial Delivered Lumens: 14,548
Initial FC at grade

Type III Medium Distribution w/Partial BLS				
LED Count (x10)	4000K		5700K	
	Initial Delivered Lumens*	BUG Ratings** Per TM-15-11	Initial Delivered Lumens*	BUG Ratings** Per TM-15-11
350mA				
02	2,079	B1 U0 G1	2,120	B1 U0 G1
04	4,158	B1 U0 G1	4,240	B1 U0 G1
06	6,166	B1 U0 G2	6,288	B1 U0 G2
08	8,221	B2 U0 G2	8,384	B2 U0 G2
10	10,252	B2 U0 G2	10,455	B2 U0 G3
12	12,302	B2 U0 G3	12,546	B2 U0 G3
14	14,261	B3 U0 G3	14,544	B3 U0 G3
16	16,299	B3 U0 G3	16,622	B3 U0 G3
525mA				
02	2,950	B1 U0 G1	3,012	B1 U0 G1
04	5,901	B1 U0 G2	6,024	B1 U0 G2
06	8,750	B2 U0 G2	8,933	B2 U0 G2
08	11,667	B2 U0 G3	11,911	B2 U0 G3
10	14,548	B3 U0 G3	14,853	B3 U0 G3
12	17,458	B3 U0 G3	17,824	B3 U0 G3
14	20,239	B3 U0 G3	20,663	B3 U0 G3
16	23,130	B3 U0 G4	23,615	B3 U0 G4
700mA				
02	3,482	B1 U0 G1	3,553	B1 U0 G1
04	6,964	B2 U0 G2	7,106	B2 U0 G2
06	10,327	B2 U0 G2	10,537	B2 U0 G3

* Initial delivered lumens at 25°C (77°F). Actual production yield may vary between -10 and +10% of initial delivered lumens

** For more information on the IES BUG (Backlight-Uplight-Glare) Rating visit: <https://www.ies.org/wp-content/uploads/2017/03/TM-15-11BUGRatingsAddendum.pdf>

Photometry

All published luminaire photometric testing performed to IESNA LM-79-08 standards by a NVLAP accredited laboratory. To obtain an IES file specific to your project consult: <http://lighting.cree.com/products/outdoor/area/cree-edge-series-1>

4M

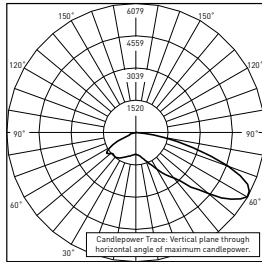

RESTL Test Report #: PL10270-001B
 ARE-EDG-4M-**-06-E-UL-525-40K
 Initial Delivered Lumens: 10,483

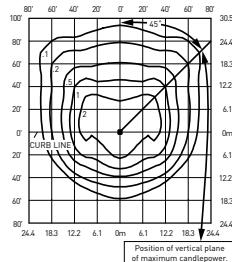

ARE-EDG-4M-**-10-E-UL-525-40K
 Mounting Height: 25' (7.6m) A.F.G.
 Initial Delivered Lumens: 17,504
 Initial FC at grade

Type IV Medium Distribution				
LED Count (x10)	4000K		5700K	
	Initial Delivered Lumens*	BUG Ratings** Per TM-15-11	Initial Delivered Lumens*	BUG Ratings** Per TM-15-11
350mA				
02	2,501	B1 U0 G1	2,551	B1 U0 G1
04	5,003	B2 U0 G1	5,102	B2 U0 G1
06	7,418	B2 U0 G2	7,565	B2 U0 G2
08	9,891	B2 U0 G2	10,087	B2 U0 G2
10	12,334	B3 U0 G3	12,578	B3 U0 G3
12	14,801	B3 U0 G3	15,094	B3 U0 G3
14	17,158	B3 U0 G3	17,498	B3 U0 G3
16	19,609	B3 U0 G3	19,998	B3 U0 G3
525mA				
02	3,550	B1 U0 G1	3,624	B1 U0 G1
04	7,099	B2 U0 G2	7,248	B2 U0 G2
06	10,527	B2 U0 G2	10,748	B2 U0 G2
08	14,037	B3 U0 G3	14,331	B3 U0 G3
10	17,504	B3 U0 G3	17,870	B3 U0 G3
12	21,004	B3 U0 G3	21,444	B3 U0 G3
14	24,350	B4 U0 G3	24,860	B4 U0 G3
16	27,828	B4 U0 G3	28,411	B4 U0 G3
700mA				
02	4,189	B1 U0 G1	4,275	B1 U0 G1
04	8,379	B2 U0 G2	8,549	B2 U0 G2
06	12,425	B3 U0 G3	12,678	B3 U0 G3

* Initial delivered lumens at 25°C (77°F). Actual production yield may vary between -10 and +10% of initial delivered lumens

** For more information on the IES BUG (Backlight-Uplight-Glare) Rating visit: <https://www.ies.org/wp-content/uploads/2017/03/TM-15-11BUGRatingsAddendum.pdf>



Photometry

All published luminaire photometric testing performed to IESNA LM-79-08 standards by a NVLAP accredited laboratory. To obtain an IES file specific to your project consult: <http://lighting.cree.com/products/outdoor/area/cree-edge-series-1>

4MB

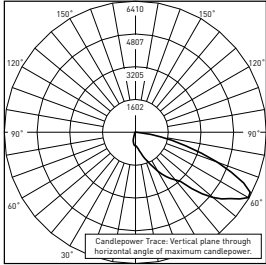

RESTL Test Report #: PL01023-002B
 ARE-EDG-4MB-**-06-E-UL-525-40K
 Initial Delivered Lumens: 7,985

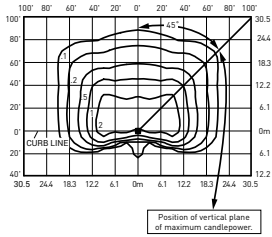

ARE-EDG-4MB-**-10-E-UL-525-40K
 Mounting Height: 25' (7.6m) A.F.G.
 Initial Delivered Lumens: 13,185
 Initial FC at grade

Type IV Medium Distribution w/BLS				
LED Count (x10)	4000K		5700K	
	Initial Delivered Lumens*	BUG Ratings** Per TM-15-11	Initial Delivered Lumens*	BUG Ratings** Per TM-15-11
350mA				
02	1,884	B0 U0 G1	1,921	B0 U0 G1
04	3,768	B1 U0 G1	3,843	B1 U0 G1
06	5,588	B1 U0 G1	5,698	B1 U0 G2
08	7,450	B1 U0 G2	7,598	B1 U0 G2
10	9,291	B1 U0 G2	9,475	B1 U0 G2
12	11,149	B1 U0 G2	11,370	B1 U0 G2
14	12,924	B1 U0 G2	13,181	B1 U0 G2
16	14,771	B2 U0 G2	15,063	B2 U0 G2
525mA				
02	2,674	B0 U0 G1	2,730	B0 U0 G1
04	5,348	B1 U0 G1	5,460	B1 U0 G1
06	7,930	B1 U0 G2	8,096	B1 U0 G2
08	10,573	B1 U0 G2	10,794	B1 U0 G2
10	13,185	B1 U0 G2	13,461	B1 U0 G2
12	15,821	B2 U0 G3	16,153	B2 U0 G3
14	18,341	B2 U0 G3	18,726	B2 U0 G3
16	20,962	B2 U0 G3	21,401	B2 U0 G3
700mA				
02	3,156	B1 U0 G1	3,220	B1 U0 G1
04	6,311	B1 U0 G2	6,440	B1 U0 G2
06	9,359	B1 U0 G2	9,549	B1 U0 G2

* Initial delivered lumens at 25°C (77°F). Actual production yield may vary between -10 and +10% of initial delivered lumens

** For more information on the IES BUG (Backlight-Uplight-Glare) Rating visit: <https://www.ies.org/wp-content/uploads/2017/03/TM-15-11BUGRatingsAddendum.pdf>

Photometry

All published luminaire photometric testing performed to IESNA LM-79-08 standards by a NVLAP accredited laboratory. To obtain an IES file specific to your project consult: <http://lighting.cree.com/products/outdoor/area/cree-edge-series-1>

4MP

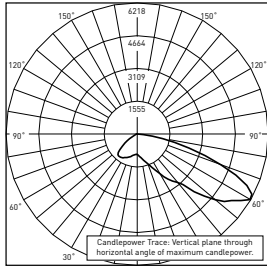

RESTL Test Report #: PL10097-003B
 ARE-EDG-4MP-**-06-E-UL-525-40K
 Initial Delivered Lumens: 9,410

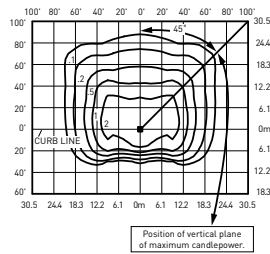

ARE-EDG-4MP-**-10-E-UL-525-40K
 Mounting Height: 25' (7.6m) A.F.G.
 Initial Delivered Lumens: 15,458
 Initial FC at grade

Type IV Medium Distribution w/Partial BLS				
LED Count (x10)	4000K		5700K	
	Initial Delivered Lumens*	BUG Ratings** Per TM-15-11	Initial Delivered Lumens*	BUG Ratings** Per TM-15-11
350mA				
02	2,209	B1 U0 G1	2,253	B1 U0 G1
04	4,418	B1 U0 G1	4,505	B1 U0 G1
06	6,551	B2 U0 G1	6,681	B2 U0 G1
08	8,735	B2 U0 G2	8,908	B2 U0 G2
10	10,892	B2 U0 G2	11,108	B2 U0 G2
12	13,071	B2 U0 G2	13,330	B2 U0 G2
14	15,153	B3 U0 G2	15,453	B3 U0 G2
16	17,317	B3 U0 G2	17,661	B3 U0 G2
525mA				
02	3,135	B1 U0 G1	3,200	B1 U0 G1
04	6,270	B2 U0 G1	6,401	B2 U0 G1
06	9,297	B2 U0 G2	9,492	B2 U0 G2
08	12,396	B2 U0 G2	12,656	B2 U0 G2
10	15,458	B3 U0 G2	15,782	B3 U0 G2
12	18,549	B3 U0 G2	18,938	B3 U0 G3
14	21,504	B3 U0 G3	21,954	B3 U0 G3
16	24,576	B3 U0 G3	25,091	B3 U0 G3
700mA				
02	3,700	B1 U0 G1	3,775	B1 U0 G1
04	7,400	B2 U0 G2	7,550	B2 U0 G2
06	10,973	B2 U0 G2	11,196	B2 U0 G2

* Initial delivered lumens at 25°C (77°F). Actual production yield may vary between -10 and +10% of initial delivered lumens

** For more information on the IES BUG (Backlight-Uplight-Glare) Rating visit: <https://www.ies.org/wp-content/uploads/2017/03/TM-15-11BUGRatingsAddendum.pdf>



Photometry

All published luminaire photometric testing performed to IESNA LM-79-08 standards by a NVLAP accredited laboratory. To obtain an IES file specific to your project consult: <http://lighting.cree.com/products/outdoor/area/cree-edge-series-1>

5M

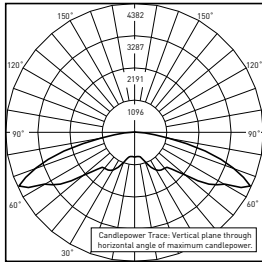

RESTL Test Report #: PL09285-001
 ARE-EDG-5M-**-06-E-UL-700-40K
 Initial Delivered Lumens: 13,136

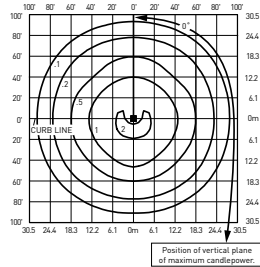

ARE-EDG-5M-**-10-E-UL-525-40K
 Mounting Height: 25' (7.6m) A.F.G.
 Initial Delivered Lumens: 18,413
 Initial FC at grade

Type V Medium Distribution				
LED Count (x10)	4000K		5700K	
	Initial Delivered Lumens*	BUG Ratings** Per TM-15-11	Initial Delivered Lumens*	BUG Ratings** Per TM-15-11
350mA				
02	2,631	B2 U0 G1	2,683	B2 U0 G1
04	5,262	B3 U0 G1	5,367	B3 U0 G1
06	7,804	B3 U0 G2	7,958	B3 U0 G2
08	10,405	B4 U0 G2	10,611	B4 U0 G2
10	12,975	B4 U0 G2	13,232	B4 U0 G2
12	15,570	B4 U0 G3	15,878	B4 U0 G3
14	18,049	B4 U0 G3	18,407	B4 U0 G3
16	20,628	B5 U0 G3	21,037	B5 U0 G3
525mA				
02	3,734	B2 U0 G1	3,812	B2 U0 G1
04	7,468	B3 U0 G2	7,625	B3 U0 G2
06	11,074	B4 U0 G2	11,306	B4 U0 G2
08	14,766	B4 U0 G2	15,075	B4 U0 G3
10	18,413	B4 U0 G3	18,799	B4 U0 G3
12	22,096	B5 U0 G3	22,558	B5 U0 G3
14	25,615	B5 U0 G3	26,151	B5 U0 G3
16	29,274	B5 U0 G3	29,887	B5 U0 G3
700mA				
02	4,407	B3 U0 G1	4,497	B3 U0 G1
04	8,814	B3 U0 G2	8,993	B3 U0 G2
06	13,070	B4 U0 G2	13,336	B4 U0 G2

* Initial delivered lumens at 25°C (77°F). Actual production yield may vary between -10 and +10% of initial delivered lumens

** For more information on the IES BUG (Backlight-Uplight-Glare) Rating visit: <https://www.ies.org/wp-content/uploads/2017/03/TM-15-11BUGRatingsAddendum.pdf>

Photometry

All published luminaire photometric testing performed to IESNA LM-79-08 standards by a NVLAP accredited laboratory. To obtain an IES file specific to your project consult: <http://lighting.cree.com/products/outdoor/area/cree-edge-series-1>

55

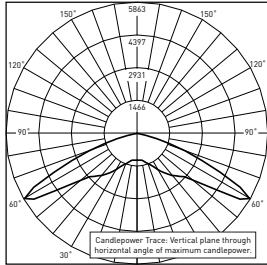

RESTL Test Report #: PLO9286-001A
 ARE-EDG-5S-**-06-E-UL-700-40K
 Initial Delivered Lumens: 14,123

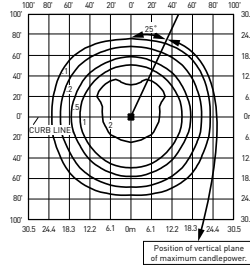

ARE-EDG-5S-**-10-E-UL-525-40K
 Mounting Height: 25' (7.6m) A.F.G.
 Initial Delivered Lumens: 20,459
 Initial FC at grade

Type V Short Distribution				
LED Count (x10)	4000K		5700K	
	Initial Delivered Lumens*	BUG Ratings** Per TM-15-11	Initial Delivered Lumens*	BUG Ratings** Per TM-15-11
350mA				
02	2,924	B2 U0 G0	2,982	B2 U0 G0
04	5,847	B3 U0 G1	5,963	B3 U0 G1
06	8,671	B3 U0 G1	8,842	B3 U0 G1
08	11,561	B3 U0 G2	11,790	B3 U0 G2
10	14,416	B4 U0 G2	14,702	B4 U0 G2
12	17,300	B4 U0 G2	17,642	B4 U0 G2
14	20,055	B4 U0 G2	20,453	B4 U0 G2
16	22,920	B4 U0 G2	23,374	B4 U0 G2
525mA				
02	4,149	B2 U0 G1	4,236	B2 U0 G1
04	8,298	B3 U0 G1	8,472	B3 U0 G1
06	12,305	B3 U0 G2	12,563	B3 U0 G2
08	16,406	B4 U0 G2	16,750	B4 U0 G2
10	20,459	B4 U0 G2	20,887	B4 U0 G2
12	24,551	B4 U0 G2	25,065	B4 U0 G2
14	28,461	B5 U0 G3	29,057	B5 U0 G3
16	32,527	B5 U0 G3	33,208	B5 U0 G3
700mA				
02	4,897	B2 U0 G1	4,996	B2 U0 G1
04	9,793	B3 U0 G1	9,993	B3 U0 G2
06	14,523	B4 U0 G2	14,818	B4 U0 G2

* Initial delivered lumens at 25°C (77°F). Actual production yield may vary between -10 and +10% of initial delivered lumens

** For more information on the IES BUG (Backlight-Uplight-Glare) Rating visit: <https://www.ies.org/wp-content/uploads/2017/03/TM-15-11BUGRatingsAddendum.pdf>



Photometry

All published luminaire photometric testing performed to IESNA LM-79-08 standards by a NVLAP accredited laboratory. To obtain an IES file specific to your project consult: <http://lighting.cree.com/products/outdoor/area/cree-edge-series-1>

25°

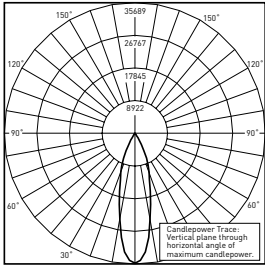

RESTL Test Report #: PL09832-003B
FLD-EDG-25-**-06-E-UL-700-40K
Initial Delivered Lumens: 14,998

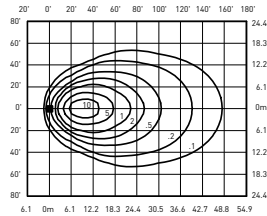

FLD-EDG-25-**-10-E-UL-525-40K
Mounting Height: 25' (7.6m) A.F.G., 60° Tilt
Initial Delivered Lumens: 20,913
Initial FC at grade

25° Flood Distribution		
LED Count (x10)	4000K	5700K
	Initial Delivered Lumens*	Initial Delivered Lumens*
350mA		
02	2,989	3,048
04	5,977	6,096
06	8,863	9,039
08	11,818	12,052
10	14,737	15,029
12	17,684	18,035
14	20,501	20,907
16	23,429	23,894
525mA		
02	4,241	4,330
04	8,482	8,660
06	12,578	12,842
08	16,771	17,122
10	20,913	21,352
12	25,096	25,622
14	29,093	29,703
16	33,250	33,946
700mA		
02	5,006	5,107
04	10,011	10,215
06	14,845	15,147

* Initial delivered lumens at 25°C (77°F). Actual production yield may vary between -10 and +10% of initial delivered lumens

Photometry

All published luminaire photometric testing performed to IESNA LM-79-08 standards by a NVLAP accredited laboratory. To obtain an IES file specific to your project consult: <http://lighting.cree.com/products/outdoor/area/cree-edge-series-1>

40°

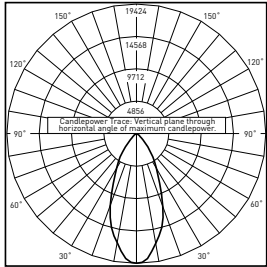

RESTL Test Report #: PL09832-002B
 FLD-EDG-40-**-06-E-UL-700-40K
 Initial Delivered Lumens: 13,808

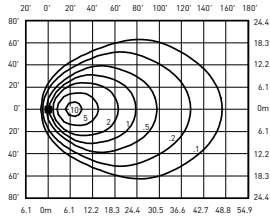

FLD-EDG-40-**-10-E-UL-525-40K
 Mounting Height: 25' (7.6m) A.F.G., 60° Tilt
 Initial Delivered Lumens: 20,459
 Initial FC at grade

40° Flood Distribution		
LED Count (x10)	4000K	5700K
	Initial Delivered Lumens*	Initial Delivered Lumens*
350mA		
02	2,924	2,982
04	5,847	5,963
06	8,671	8,842
08	11,561	11,790
10	14,416	14,702
12	17,300	17,642
14	20,055	20,453
16	22,920	23,374
525mA		
02	4,149	4,236
04	8,298	8,472
06	12,305	12,563
08	16,406	16,750
10	20,459	20,887
12	24,551	25,065
14	28,461	29,057
16	32,527	33,208
700mA		
02	4,897	4,996
04	9,793	9,993
06	14,523	14,818

* Initial delivered lumens at 25°C (77°F). Actual production yield may vary between -10 and +10% of initial delivered lumens



Photometry

All published luminaire photometric testing performed to IESNA LM-79-08 standards by a NVLAP accredited laboratory. To obtain an IES file specific to your project consult: <http://lighting.cree.com/products/outdoor/area/cree-edge-series-1>

70°

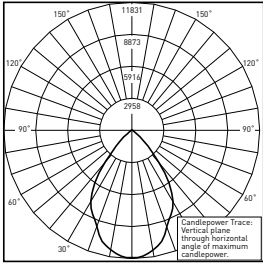

RESTL Test Report #: PL09832-001B
 FLD-EDG-70-**-06-E-UL-700-40K
 Initial Delivered Lumens: 13,888

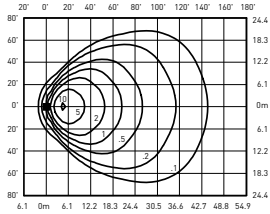

FLD-EDG-70-**-10-E-UL-525-40K
 Mounting Height: 25' (7.6m) A.F.G., 60° Tilt
 Initial Delivered Lumens: 18,640
 Initial FC at grade

70° Flood Distribution		
LED Count (x10)	4000K	5700K
	Initial Delivered Lumens*	Initial Delivered Lumens*
350mA		
02	2,664	2,716
04	5,327	5,433
06	7,900	8,056
08	10,533	10,742
10	13,135	13,395
12	15,762	16,074
14	18,272	18,635
16	20,883	21,297
525mA		
02	3,780	3,859
04	7,560	7,719
06	11,211	11,446
08	14,948	15,261
10	18,640	19,031
12	22,368	22,837
14	25,931	26,474
16	29,636	30,256
700mA		
02	4,461	4,552
04	8,923	9,104
06	13,232	13,501

* Initial delivered lumens at 25°C (77°F). Actual production yield may vary between -10 and +10% of initial delivered lumens

Photometry

All published luminaire photometric testing performed to IESNA LM-79-08 standards by a NVLAP accredited laboratory. To obtain an IES file specific to your project consult: <http://lighting.cree.com/products/outdoor/area/cree-edge-series-1>

SN

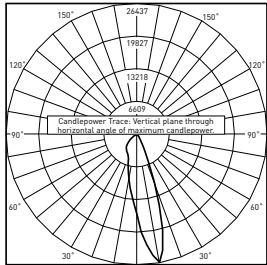

RESTL Test Report #: PL10142-001B
 FLD-EDG-SN-**-06-E-UL-700-40K
 Initial Delivered Lumens: 13,701

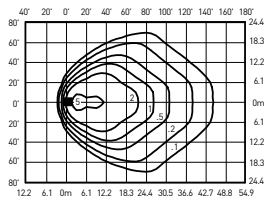

FLD-EDG-SN-**-10-E-UL-525-40K
 Mounting Height: 25' (7.6m) A.F.G., 60° Tilt
 Initial Delivered Lumens: 18,868
 Initial FC at grade

SN Flood Distribution		
LED Count (x10)	4000K	5700K
	Initial Delivered Lumens*	Initial Delivered Lumens*
350mA		
02	2,696	2,750
04	5,392	5,499
06	7,996	8,155
08	10,662	10,873
10	13,295	13,559
12	15,954	16,270
14	18,495	18,862
16	21,137	21,556
525mA		
02	3,826	3,906
04	7,653	7,813
06	11,348	11,585
08	15,130	15,447
10	18,868	19,263
12	22,641	23,115
14	26,247	26,797
16	29,997	30,625
700mA		
02	4,516	4,608
04	9,032	9,215
06	13,393	13,665

* Initial delivered lumens at 25°C (77°F). Actual production yield may vary between -10 and +10% of initial delivered lumens

Photometry

All published luminaire photometric testing performed to IESNA LM-79-08 standards by a NVLAP accredited laboratory. To obtain an IES file specific to your project consult: <http://lighting.cree.com/products/outdoor/area/cree-edge-series-1>

N6

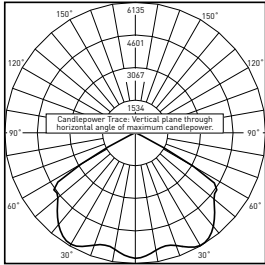

RESTL Test Report #: PL09832-004B
 FLD-EDG-N6-**-D6-E-UL-700-40K
 Initial Delivered Lumens: 15,251

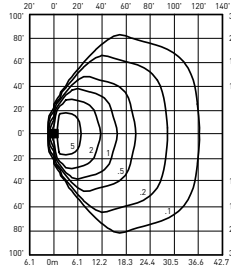















FLD-EDG-N6-**-10-E-UL-525-40K
 Mounting Height: 25' (7.6m) A.F.G., 60° Tilt
 Initial Delivered Lumens: 20,913
 Initial FC at grade

NEMA® 6 Flood Distribution		
LED Count (x10)	4000K	5700K
	Initial Delivered Lumens*	Initial Delivered Lumens*
350mA		
02	2,989	3,048
04	5,977	6,096
06	8,863	9,039
08	11,818	12,052
10	14,737	15,029
12	17,684	18,035
14	20,501	20,907
16	23,429	23,894
525mA		
02	4,241	4,330
04	8,482	8,660
06	12,578	12,842
08	16,771	17,122
10	20,913	21,352
12	25,096	25,622
14	29,093	29,703
16	33,250	33,946
700mA		
02	5,006	5,107
04	10,011	10,215
06	14,845	15,147

* Initial delivered lumens at 25°C (77°F). Actual production yield may vary between -10 and +10% of initial delivered lumens

Luminaire EPA









Fixed Arm Mount – ARE-EDG-DA						
LED Count (x10)	Single	2 @ 90°	2 @ 180°	3 @ 90°	3 @ 120°	4 @ 90°
						
02	0.60	0.87	1.20	1.47	1.47	1.75
04	0.60	0.87	1.20	1.47	1.47	1.75
06	0.60	0.92	1.20	1.51	1.51	1.83
08	0.60	0.96 N/A with 3" poles	1.20	1.55 N/A with 3" poles	1.55	1.91 N/A with 3" poles
10	0.60	1.00 N/A with 3" poles	1.20	1.60 N/A with 3" poles	1.60	2.00 N/A with 3" poles
12	0.60	1.04 N/A with 3" poles	1.20	1.64 N/A with 3" poles	1.64	2.08 N/A with 3" poles
14	0.60	1.08 N/A with 3" or 4" poles	1.20	1.68 N/A with 3" or 4" poles	1.68	2.16 N/A with 3" or 4" poles
16	0.60	1.12 N/A with 3" or 4" poles	1.20	1.72 N/A with 3" or 4" poles	1.72	2.24 N/A with 3" or 4" poles
Fixed Arm Mount – ARE-EDG-DL						
02	0.75	1.02	1.50	1.77	1.77	1.91
04	0.75	1.02	1.50	1.77	1.77	1.91
06	0.75	1.07	1.50	1.82	1.82	1.98
08	0.75	1.11	1.50	1.86	1.86	2.04
10	0.75	1.15	1.50	1.90	1.90	2.10
12	0.75	1.19	1.50	1.94	1.94	2.16
14	0.75	1.23	1.50	1.98	1.98	2.22
16	0.75	1.27	1.50	2.02	2.02	2.28

Adjustable Arm Mount – ARE-EDG-AA/FLD-EDG-AA/SA									
LED Count (x10)	Single	2 @ 90°	2 @ 180°	In-Line 2 @ 180°	3 @ 90°	3 @ 120°	In-Line 3 @ 180°	4 @ 90°	In-Line 4 @ 180°
Tenon Configuration If used with Cree tenons, please add tenon EPA with Luminaire EPA									
									
	Vertical: PB-1A*; PT-1; PW-1A3** Horizontal: By others	Vertical: PB-2A*; PB-2R2.375; PW-2A3** Horizontal: PD-2A4(90); PT-2(90)	Vertical: PB-2A*; PB-2R2.375; PW-2A3** Horizontal: PD-2A4(180); PT-2(180)	Vertical: PB-2A*; PB-2R2.375	Vertical: PB-3A*; PB-3R2.375 Horizontal: PD-3A4(90); PT-3(90)	Vertical: PB-3A*; PB-3R2.375 Horizontal: PT-3(120)	Vertical: PB-3A*; PB-3R2.375	Vertical: PB-4A*(90); PB-4R2.375 Horizontal: PD-4A4(90) PT-4(90)	Vertical: PB-4A*(180); PB-4R2.375
0° Tilt									
02	0.66	0.98	1.32	1.32	1.77	1.64	1.98	1.91	2.64
04	0.66	0.98	1.32	1.32	1.64	1.64	1.98	1.97	2.64
06	0.66	1.02	1.32	1.32	1.68	1.68	1.98	2.05	2.64
08	0.66	1.07	1.32	1.32	1.80	1.72	1.98	2.29	2.64
10	0.66	1.11	1.32	1.32	1.76	1.76	1.98	2.21	2.64
12	0.66	1.15	1.32	1.32	1.80	1.80	1.98	2.29	2.64
14	0.66	1.19	1.32	1.32	1.84	1.84	1.98	2.38	2.64
16	0.66	1.23	1.32	N/A	1.89	1.89	N/A	2.46	N/A

* Specify pole size: 3 (3"), 4 (4"), 5 (5"), or 6 (6") for single, double or triple luminaire orientation or 4 (4"), 5 (5"), or 6 (6") for quad luminaire orientation
 ** These EPA values must be multiplied by the following ratio: Fixture Mounting Height/Total Pole Height. Specify pole size: 3 (3"), 4 (4"), 5 (5"), or 6 (6")



Luminaire EPA

Adjustable Arm Mount – ARE-EDG-AA/FLD-EDG-AA/SA									
LED Count (x10)	Single	2 @ 90°	2 @ 180°	In-Line 2 @ 180°	3 @ 90°	3 @ 120°	In-Line 3 @ 180°	4 @ 90°	In-Line 4 @ 180°
Tenon Configuration If used with Cree tenons, please add tenon EPA with Luminaire EPA									
									
	Vertical: PB-1A*; PT-1; PW-1A3** Horizontal: By others	Vertical: PB-2A*; PB-2R2.375; PW-2A3** Horizontal: PD-2A4(90); PT-2(90)	Vertical: PB-2A*; PB-2R2.375; PW-2A3** Horizontal: PD-2A4(180); PT-2(180)	Vertical: PB-2A*; PB-2R2.375	Vertical: PB-3A*; PB-3R2.375 Horizontal: PD-3A4(90); PT-3(90)	Vertical: PB-3A*; PB-3R2.375 Horizontal: PT-3(120)	Vertical: PB-3A*; PB-3R2.375	Vertical: PB-4A*(90); PB-4R2.375 Horizontal: PD-4A4(90) PT-4(90)	Vertical: PB-4A*(180); PB-4R2.375
30° Tilt									
02	0.71	1.37	1.42	1.42	2.08	2.08	2.13	2.73	2.84
04	0.71	1.37	1.42	1.42	2.08	2.08	2.13	2.73	2.84
06	0.82	1.48	1.64	1.64	2.30	2.30	2.46	2.95	3.28
08	0.93	1.59	1.86	1.86	2.52	2.52	2.79	3.17	3.72
10	1.04	1.70	2.08	2.08	2.74	2.74	3.12	3.40	4.16
12	1.15	1.81	2.30	2.30	2.96	2.96	3.45	3.62	4.60
14	1.26	1.92	2.52	2.52	3.18	3.18	3.78	3.84	5.04
16	1.37	2.03	2.74	N/A	3.40	3.40	N/A	4.06	N/A
45° Tilt									
02	0.89	1.55	1.78	1.78	2.45	2.45	2.67	3.10	3.56
04	0.89	1.55	1.78	1.78	2.45	2.45	2.67	3.10	3.56
06	1.03	1.69	2.06	2.06	2.72	2.72	3.09	3.38	4.12
08	1.17	1.83	2.34	2.34	3.00	3.00	3.51	3.66	4.68
10	1.31	1.97	2.62	2.62	3.28	3.28	3.93	3.94	5.24
12	1.45	2.11	2.90	2.90	3.56	3.56	4.35	4.21	5.80
14	1.59	2.25	3.18	3.18	3.83	3.83	4.77	4.49	6.36
16	1.73	2.38	3.46	N/A	4.11	4.11	N/A	4.77	N/A
60° Tilt									
02	1.20	1.86	2.40	2.40	3.06	3.06	3.60	3.72	4.80
04	1.20	1.86	2.40	2.40	3.06	3.06	3.60	3.72	4.80
06	1.39	2.05	2.78	2.78	3.44	3.44	4.17	4.10	5.56
08	1.58	2.23	3.16	3.16	3.81	3.81	4.74	4.47	6.32
10	1.77	2.42	3.54	3.54	4.19	4.19	5.31	4.84	7.08
12	1.95	2.61	3.90	3.90	4.56	4.56	5.85	5.22	7.80
14	2.14	2.80	4.28	4.28	4.94	4.94	6.42	5.59	8.56
16	2.33	2.98	4.66	N/A	5.31	5.31	N/A	5.97	N/A

* Specify pole size: 3 [3"], 4 [4"], 5 [5"], or 6 [6"] for single, double or triple luminaire orientation or 4 [4"], 5 [5"], or 6 [6"] for quad luminaire orientation
 ** These EPA values must be multiplied by the following ratio: Fixture Mounting Height/Total Pole Height. Specify pole size: 3 [3"], 4 [4"], 5 [5"], or 6 [6"]



Luminaire EPA

Adjustable Arm Mount – ARE-EDG-AA/FLD-EDG-AA/SA									
LED Count (x10)	Single	2 @ 90°	2 @ 180°	In-Line 2 @ 180°	3 @ 90°	3 @ 120°	In-Line 3 @ 180°	4 @ 90°	In-Line 4 @ 180°
Tenon Configuration If used with Cree tenons, please add tenon EPA with Luminaire EPA									
	Vertical: PB-1A*; PT-1; PW-1A3** Horizontal: By others	Vertical: PB-2A*; PB-2R2.375; PW-2A3** Horizontal: PD-2A4(90); PT-2(90)	Vertical: PB-2A*; PB-2R2.375; PW-2A3** Horizontal: PD-2A4(180); PT-2(180)	Vertical: PB-2A*; PB-2R2.375	Vertical: PB-3A*; PB-3R2.375 Horizontal: PD-3A4(90); PT-3(90)	Vertical: PB-3A*; PB-3R2.375 Horizontal: PT-3(120)	Vertical: PB-3A*; PB-3R2.375	Vertical: PB-4A*(90); PB-4R2.375 Horizontal: PD-4A4(90) PT-4(90)	Vertical: PB-4A*(180); PB-4R2.375
90° Tilt									
02	1.85	2.51	3.70	3.64	4.36	4.36	5.55	5.02	7.40
04	1.85	2.51	3.70	3.64	4.36	4.36	5.55	5.02	7.40
06	2.14	2.80	4.28	4.22	4.94	4.94	6.42	5.59	8.56
08	2.43	3.09	4.86	4.78	5.51	5.51	7.29	6.17 N/A with horizontal tenon	9.72
10	2.71	3.37	5.42	5.34	6.08	6.08	8.13	6.74 N/A with horizontal tenon	10.84
12	3.00	3.66	6.00	5.90	6.66	6.66	9.00	7.31 N/A with horizontal tenon	12.00
14	3.29	3.95 N/A with PW-2A3**	6.58	6.48	7.23	7.23	9.87	7.89 N/A with horizontal tenon	13.16
16	3.57	4.23 N/A with PW-2A3**	7.14	N/A	7.81	7.81	N/A	8.46 N/A with horizontal tenon	N/A

* Specify pole size: 3 [3"], 4 [4"], 5 [5"], or 6 [6"] for single, double or triple luminaire orientation or 4 [4"], 5 [5"], or 6 [6"] for quad luminaire orientation
 ** These EPA values must be multiplied by the following ratio: Fixture Mounting Height/Total Pole Height. Specify pole size: 3 [3"], 4 [4"], 5 [5"], or 6 [6"]

Tenon EPA

Part Number	EPA
PB-1A*	None
PB-2A*	0.82
PB-3A*	1.52
PB-4A*(180)	2.22
PB-4A*(90)	1.11
PB-2R2.375	0.92
PB-3R2.375	1.62
PB-4R2.375	2.32
PD Series Tenons	0.09
PT Series Tenons	0.10
PW-1A3**	0.47
PW-2A3**	0.94
WM-2	0.08
WM-4	0.25
WM-DM	None

* Specify pole size: 3 [3"], 4 [4"], 5 [5"], or 6 [6"] for single, double or triple luminaire orientation or 4 [4"], 5 [5"], or 6 [6"] for quad luminaire orientation
 ** These EPA values must be multiplied by the following ratio: Fixture Mounting Height/Total Pole Height. Specify pole size: 3 [3"], 4 [4"], 5 [5"], or 6 [6"]

Tenons and Brackets [†] (must specify color)	
<p>Square Internal Mount Vertical Tenons (Steel) - Mounts to 3-6" [76-152mm] square aluminum or steel poles PB-1A* – Single PB-4A*(90) – 90° Quad PB-2A* – 180° Twin PB-4A*(180) – 180° Quad PB-3A* – 180° Triple</p> <p>Square Internal Mount Horizontal Tenons (Aluminum) - Mounts to 4" [102mm] square aluminum or steel poles PD-2A4(90) – 90° Twin PD-3A4(90) – 90° Triple PD-2A4(180) – 180° Twin PD-4A4(90) – 90° Quad</p> <p>Wall Mount Brackets - Mounts to wall or roof WM-2 – Horizontal for AA and SA mounts WM-4 – L-Shape for AA and SA mounts WM-DM – Plate for DA and DL mounts</p>	<p>Round External Mount Vertical Tenons (Steel) - Mounts to 2.375" [60mm] O.D. round aluminum or steel poles or tenons PB-2R2.375 – Twin PB-4R2.375 – Quad PB-3R2.375 – Triple</p> <p>Round External Mount Horizontal Tenons (Aluminum) - Mounts to 2.375" [60mm] O.D. round aluminum or steel poles or tenons - Mounts to square pole with PB-1A* tenon PT-1 – Single (Vertical) PT-3(90) – 90° Triple PT-2(90) – 90° Twin PT-4(90) – 90° Quad PT-2(180) – 180° Twin</p> <p>Mid-Pole Bracket - Mounts to square pole PW-1A3** – Single PW-2A3** – Double</p> <p>Ground Mount Post - For ground mounted flood luminaires PGM-1 - For use with AA and SA mounts</p>

[†] Refer to the [Bracket and Tenons spec sheet](#) for more details



AA Mount

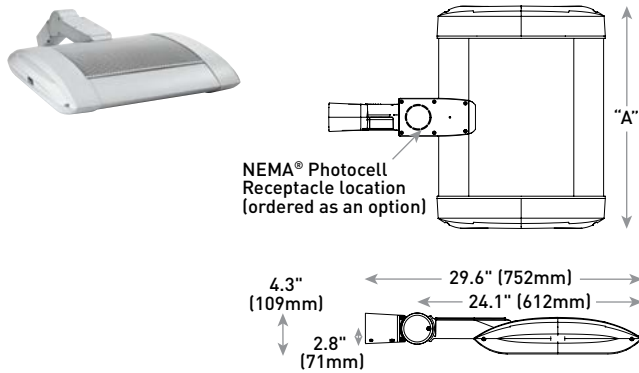

LED Count (x10)	Dim. "A"	Weight
02	12.1" (306mm)	21 lbs. (10kg)
04	12.1" (306mm)	24 lbs. (11kg)
06	14.1" (357mm)	27 lbs. (12kg)
08	16.1" (408mm)	28 lbs. (13kg)
10	18.1" (459mm)	32 lbs. (15kg)
12	20.1" (510mm)	34 lbs. (15kg)
14	22.1" (560mm)	37 lbs. (17kg)
16	24.1" (611mm)	41 lbs. (19kg)

DL Mount

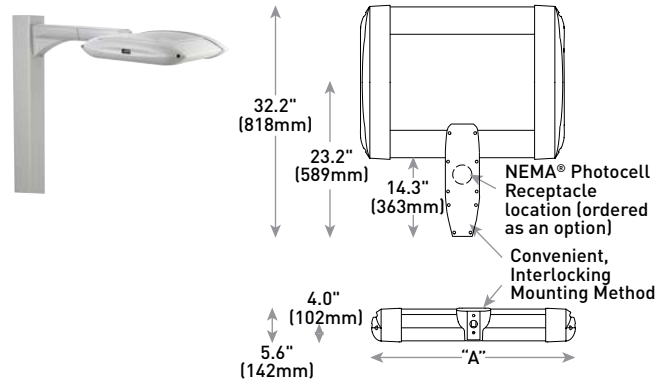

LED Count (x10)	Dim. "A"	Weight
02	12.1" (306mm)	23 lbs. (10kg)
04	12.1" (306mm)	26 lbs. (12kg)
06	14.1" (357mm)	29 lbs. (13kg)
08	16.1" (408mm)	30 lbs. (14kg)
10	18.1" (459mm)	34 lbs. (15kg)
12	20.1" (510mm)	36 lbs. (16kg)
14	22.1" (560mm)	42 lbs. (19kg)
16	24.1" (611mm)	44 lbs. (20kg)

SA Mount

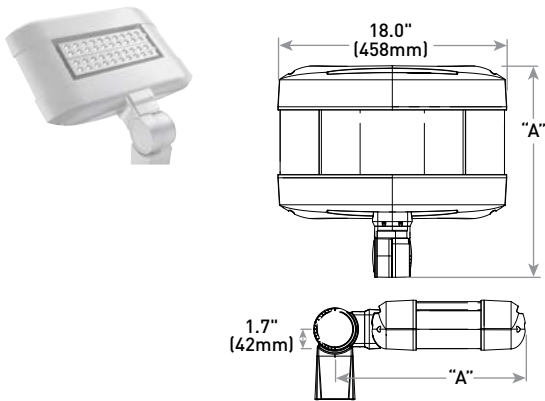

LED Count (x10)	Dim. "A"	Weight
02	16.0" (406mm)	25 lbs. (11kg)
04	18.0" (457mm)	26 lbs. (12kg)
06	20.0" (508mm)	28 lbs. (13kg)