

DFS61 - Instructions



1460nm SWIR - Short-Wave Infrared

Features:

- Detects water based fluid
- Intuitive numerical/percentage diagnostic OLED display
- Attractive 10mm wide housing
- Low power & wide operating voltage
- Advanced remote programming
- Six **AUTOSET** modes including window
- Crosstalk rejection between two sensors without a wire
- Programmable output/input configurations
- Combinable dual timers, and counters

How To Specify

- 1. Select Sensor: DFS61**
Short-wave Infrared
Digital Fiber Optic Sensor
- 2. Select Light Source:**
I = SWIR (1460nm)
- 3. Select Connection:**
Blank = 6ft cable (1.8m)
C = 4-pin M8 connector

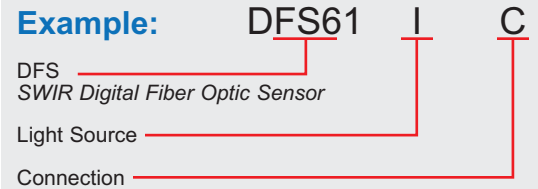

Features

WIDE VARIETY OF FIBERS
Visit www.ttco.com for full listing.

AUTOSET (●)
Push to perform AUTOSET.

THRESHOLD/VALUE ADJUST ROCKER (▼▲)
1. Manually adjusts the threshold. +/-
2. Alters programming parameters. +/-
Hold to scroll for numeric values.

MODE (■)
1. Tap to display sensor status screen.
2. Tap again to access parameters.

CONNECTION
4-Pin M8 connector or built-in cable.

FIBER RELEASE CLAMP
Locks fibers in place.

OUTPUT LEDS
1. Illuminates solid when output is ON.
2. Flashes when output is overloaded.

ADVANCED DIAGNOSTIC OLED DISPLAY
See next page for complete listing.

INPUT FUNCTION LIGHT RING
Illuminates when input is activated.
Note: Only available on connector models.

Quick Start The Digital Fiber Optic Sensor is designed to provide reliable detection using fiber optic light guides. Sensor is adjusted by a single push of a button; there is no guess work on the part of the operator. The sensor *default settings** (Light State) will work for most applications.

Follow the three step procedure below:

* Note: Consult all default settings on page 6.

- Establish one of the following conditions:
Beam Make/Proximity - Reflect light off object.
Beam Break - Remove object from light beam path.

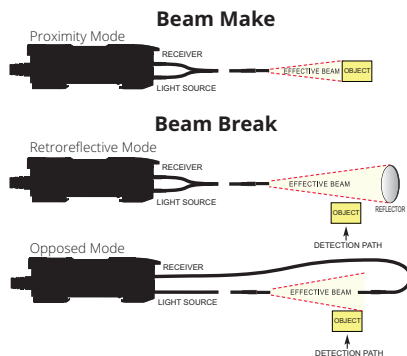

- Tap **AUTOSET (●)** button:
 Pressing the AUTOSET button sets the sensors threshold to the desired level.

- Verify setup on advanced diagnostic OLED display. If needed, the threshold can be altered by tapping up or down on the threshold adjust rocker.



Programming

 The DFS performance, AUTOSET function, output configuration, and other features can be tailored to your unique application. Follow the programming procedure contained in this section.

- Tap **MODE** (■) to show status screen. Status Screen shows a quick overview of sensor's settings.

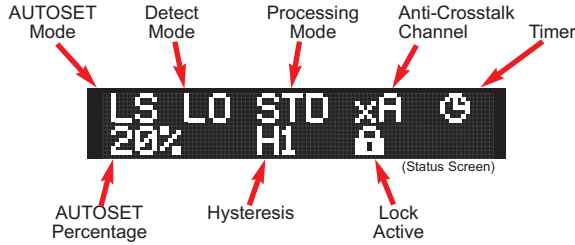

Note: Programming will time out after 60 seconds if no action is taken. Tap and hold to exit status screen.

- Tap **MODE** (■) again to access first parameter. Continue tapping to select desired parameter. Use the threshold/value **ADJUST ROCKER** (▼▲) to select or adjust a specific parameter.

AUTOSET Modes

The sensor's automatic threshold adjustment is controlled by the AUTOSET mode. Each AUTOSET mode sets the threshold differently. Select the mode that works best for your specific application. See details at the left.



- AUTOSET Mode: Light State LS** **Light-State Set (LS):** Sets threshold below received light beam intensity.
- AUTOSET Mode: Dark State DS** **Dark-State Set (DS):** Sets threshold above received light beam intensity.
- AUTOSET Mode: Midpoint MP** **Midpoint Set (MP):** Sets threshold at received light beam intensity.
- AUTOSET Mode: Two-Point 2P** **Two-point Set (2P):** Sets threshold between received light beam intensity two point.
- AUTOSET Mode: Dynamic DY** **Dynamic Set (DY):** Sets threshold between received light beam high and low intensity.
- AUTOSET Mode: Window WN** **Window Set (WN):** Sets two thresholds equally spaced above and below received light beam intensity. Received light beam intensity within the window is a valid detect. Outside the window is not a valid detect.

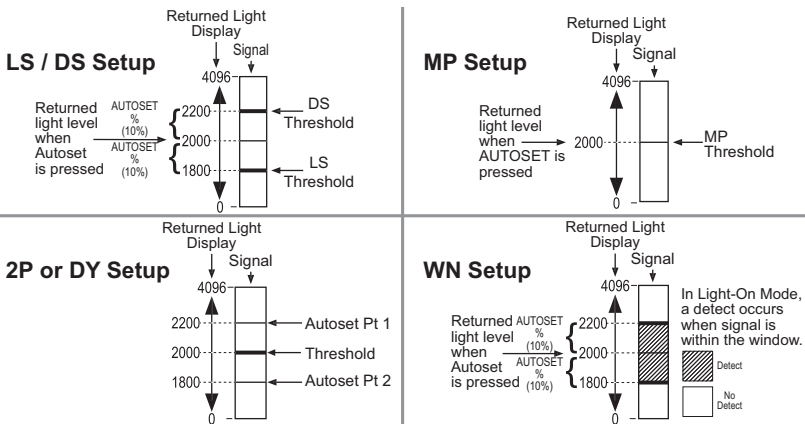

AUTOSET Percent

For Light State (LS), Dark State (DS), and Window AUTOSET Modes (WN), the offset percentage is adjustable. AUTOSET Percent determines threshold placement during AUTOSET. Placement is a percentage of received light beam intensity.

ADJUST 10% - 50% (Hold to scroll)



Using AUTOSET



The DFS threshold is set automatically by pressing the **AUTOSET** button. There are six different ways the sensor determines the threshold. The user first must determine which type of setup mode is appropriate for the application. The simplest and most common mode we recommend is Light State (LS) setup. It is used in both beam make and beam break sensing. When using this mode, the sensor will provide the best sensitivity to fine changes in light level or contrast. This is useful for small part detection and precise leading-edge triggering. Please consult our website at <https://www.tco.com/sensors/fundamentals> or contact one of our worldwide distributors for application help. We look forward to providing any assistance you may need.

Note: OLED display will provide intuitive visual feedback during autosetting. Paying close attention to the display is important.

Light State (Default)

Place object to be detected in the worst-case light-state condition and press the AUTOSET button. The threshold will be set 10%(default) below the received light-beam intensity. The threshold can be altered by tapping up or down on the threshold adjust rocker (see Figure 1).

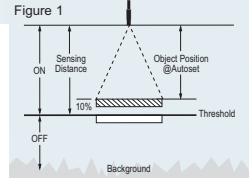

Dark State

Place object to be detected in the worst-case dark-state condition and press the AUTOSET button. The threshold will be set 10%(default) above the received light-beam intensity. The threshold can be altered by tapping up or down on the threshold adjust rocker (see Figure 2).

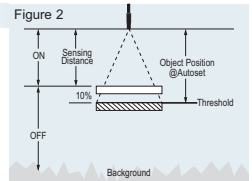

Midpoint

Place object to be detected in position at which you want the threshold to be set and press the AUTOSET button. The threshold can be altered by tapping up or down on the threshold adjust rocker (see Figure 3).

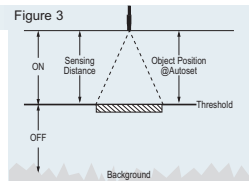

Two-Point

Place object to be detected in the light-state condition and press the AUTOSET button. Then remove or place the object in the dark-state condition and press the AUTOSET button again. The threshold will be set between the two light-beam intensities. The threshold can be altered by tapping up or down on the threshold adjust rocker (see Figure 4).

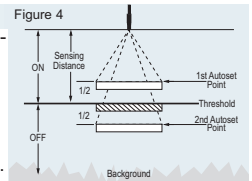

Dynamic

Press the AUTOSET button to start the Dynamic AUTOSET. Now move the object through the beam at least once and press the AUTOSET button again to complete the Dynamic AUTOSET. The threshold is set between the highest and lowest received light levels caused by the object being passed through. The threshold can be altered by tapping up or down on the threshold adjust rocker (see Figure 5).

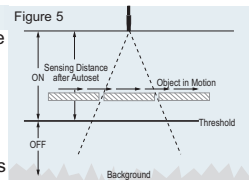

Window

Window mode is a unique type of AUTOSET mode. Window mode creates two thresholds and can be used in a similar manner as a dual channel fiber optic sensor. Place the object in the position at which you want to be reliably detect it and press the AUTOSET button. The DFS will place two thresholds 10%(default) higher and 10%(default) lower than the returned light level. Now when the object is passed in view or through the fiber optic the object will be detected in the same position +/- 10%. The threshold offset (both thresholds) can be altered by tapping up or down on the threshold adjust rocker (see Figure 6).

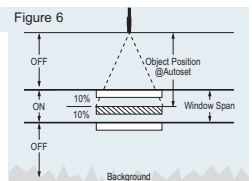

Detect Mode

Sensor output activates or deactivated when received light intensity is over the threshold. *Not available when input function is set to Remote Dark On.*

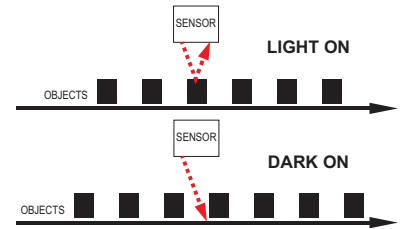

Detect Mode:
Light On LO

Light On (LO): Output activates when received light intensity is over the threshold. *Note: In window mode (WN) output activates when received light intensity is inside the window thresholds.*

Detect Mode:
Dark On DO

Dark On (DO): Output deactivates when received light intensity is over the threshold. *Note: In window mode (WN) output activates when received light intensity is outside the window thresholds.*

Response Time

Select which mode that best fits the performance need of your application. Sensor speed, range, and sensitivity are optimized for best performance.



Response Time:
High-Speed

High-Speed (HS): Fast response time with higher sensitivity (250µs). *Not available in Asynchronous Anti-Crosstalk Mode.*

Response Time:
Standard

Standard (STD): Good balance of response time and range for general purpose sensing (1ms).

Hysteresis

To avoid false triggers for example due to object vibration. Adjusts the span between the operate point and the release point of the sensor output. Low hysteresis increases sensitivity and high hysteresis increases sensing stability.



Hysteresis:
Low H0

Low (H0): Reduced hysteresis for increased sensitivity.

Hysteresis:
Standard H1

Standard (H1): Automatic adjustment depending on signal level.

Hysteresis:
High H2

High (H2): Increased hysteresis for increased stability.

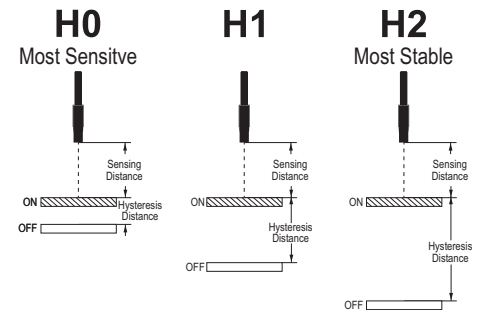

Anti-Crosstalk

Turns on Asynchronous Anti-Crosstalk rejection for two sensors. *Note: Channels 1 and 2 cannot be set as Channels A and B; anti-crosstalk is for use of two separate sensors. Not available for HS mode.*



Anti-Crosstalk:
Disabled

Disabled: Turns off Anti-Crosstalk rejection.

Async Crosstalk:
Channel A xA
Channel B xB

Assign one sensor to channel A and the other to channel B.

Asynchronous Crosstalk

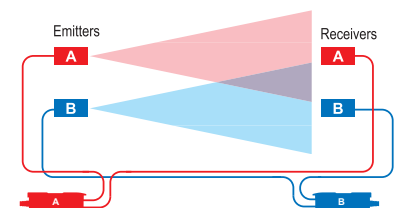

PRESS Timer/Counter Function #:

Choose from 19 pre-configured timer/counter control functions. Each one represents a function such as on-delay, off-delay, etc. Once a function is selected, adjustable parameters of that function appear such as delay time.

Timer Duration

ADJUST **On Delay:** 10ms

▲ ▼ **0.1 - 9.9, 10 - 9999ms**

Hold up or down to scroll.

Counter

ADJUST **Count:** 0005

▲ ▼ **0001-9999**

Hold up or down to scroll.

Select ▲ ▼

<p>00</p> <p>Timer Func: 00 Bypass</p> <p>Timer not used.</p>	<p>10</p> <p>Timer Func: 10 Off, Latch</p> <p>"OFF" Delay then Latch</p>
<p>01</p> <p>Timer Func: 01 On-Delay</p> <p>"ON" Delay</p>	<p>11</p> <p>Timer Func: 11 Blind One-Shot</p> <p>Blind One-Shot</p>
<p>02</p> <p>Timer Func: 02 Off-Delay</p> <p>"OFF" Delay Pulse Stretcher</p>	<p>12</p> <p>Timer Func: 12 Delayed One-Shot</p> <p>One-Shot Delay, then One-Shot</p>
<p>03</p> <p>Timer Func: 03 One-Shot</p> <p>One-Shot</p>	<p>13</p> <p>Timer Func: 13 Delayed Latch</p> <p>One-Shot Delay, then Latch</p>
<p>04</p> <p>Timer Func: 04 Motion</p> <p>Motion Detection</p>	<p>14</p> <p>Timer Func: 14 Stop, One-Shot</p> <p>Stop Motion, then One-Shot</p>
<p>05</p> <p>Timer Func: 05 Latch</p> <p>Latching, Edge Triggered</p>	<p>15</p> <p>Timer Func: 15 Stop, Latch</p> <p>Stop Motion, then Latch</p>
<p>06</p> <p>Timer Func: 06 On, Off-Delay</p> <p>"ON" Delay then "OFF" Delay</p>	<p>16</p> <p>Timer Func: 16 Latch, On-Delay</p> <p>Latch then "ON" Delay</p>
<p>07</p> <p>Timer Func: 07 On, One-Shot</p> <p>"ON" Delay, then One-Shot</p>	<p>17</p> <p>Timer Func: 17 Latch, One-Shot</p> <p>Latch, then One-Shot</p>
<p>08</p> <p>Timer Func: 08 On, Latch</p> <p>"ON" Delay then Latch</p>	<p>18</p> <p>Timer Func: 18 Count, One-Shot</p> <p>Count, One-Shot</p>
<p>09</p> <p>Timer Func: 09 Off, One-Shot</p> <p>"OFF" Delay then One-Shot</p>	<p>19</p> <p>Timer Func: 00 Count, Latch</p> <p>Count, Latch</p>

Output Type

- The sensor has configurable Q1 (primary; black wire) and Q2 (secondary; white wire) I/O signals. Select the way the connector signals function and route. Refer to drawing for sensor pinout.



Output Type: ↑⊗
Single / Input

Single Output with Remote Input: Q1 is output and Q2 is input. Q1 can be set to either sinking or sourcing outputs. Q2 can be set to either sinking or sourcing input. See input wire configuration for available functions.

Output Type: ↑↑
Redundant

Redundant: Q1 and Q2 activate together. Q1 and Q2 can be set to either sinking or sourcing outputs.

Output Type: ↑↓
Complementary

Complementary: Q1 and Q2 alternate activation. When Q1 is on Q2 is off and vice versa. Q1 and Q2 can be set to either sinking or sourcing outputs.

Output Type: ↑↓
Classic PNP/NPN

Classic: Q1 and Q2 activate together. Q1 is set to sourcing (PNP) and Q2 is set to sinking (NPN).

One other output type is automatically selected when required by other settings:

Output Type: ↑⊗
Single / Reset

Single Output / Reset: Q1 is an output and Q2 is reserved for a latch reset. Q1 can be set to either sinking or sourcing output.

Note: In this mode the output type is required to be Single/Reset and cannot be changed.

The DFS Q1 and Q2 pins are configurable.

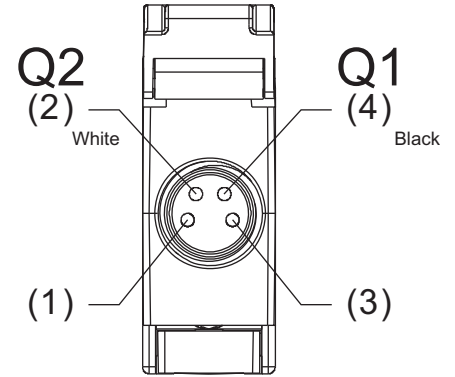

Output Mode

When configured as an output Q1 and Q2 can be set one of three ways:



Output Mode: ↑
PNP - Source

PNP - Source: PNP transistor open collector output.

Output Mode: ↓
NPN - Sink

NPN - Sink: NPN transistor open collector output.

Output Mode: ⊕
Push/Pull

Push/Pull: NPN and PNP transistor connected in a push/pull configuration.

Input Functions

When Q2 is programmed as an input, several different functions can be performed. *Not available for Redundant, Complementary, and Classic.*



Input Function: Remote Set

Remote set: An AUTOSSET function is performed when input wire is transitioned from idle to active and returned. *Note: input wire can be used in addition to the AUTOSSET button.*

Input Function: Remote Command

Remote command: Sensor parameters can be adjusted via defined pulses. See chart on page 7.

Input Function: Interrogate

Interrogate: Sensor output is latched when input wire is transitioned from idle to active.

Input Function: Gate

Gate: Sensing is gated. Detection is enabled when input is active.

Input Function: Remote Dark On

Remote Dark On: Detect Mode is determined by input state. Dark On mode is used when input is active.

Input Function: Remote Lockout

Remote Lockout: Remote lock of the AUTOSSET, up and down adjust and most mode functions.

Input Polarity

Select the active state of the input. *Not available for Redundant, Complementary, and Classic.*



Input Polarity: Active High ↑

Active High: Selects active High.

Input Polarity: Active Low ↓

Active Low: Selects active Low.

■ **Display Mode** Selects between numeric and percentage modes and flips orientation.

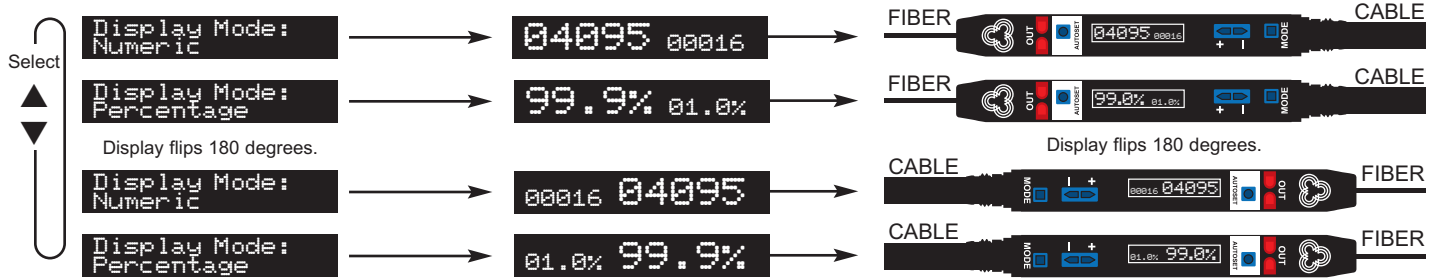

■ **Lock Mode** Locks buttons. *Note: Input wire remains unlocked.*

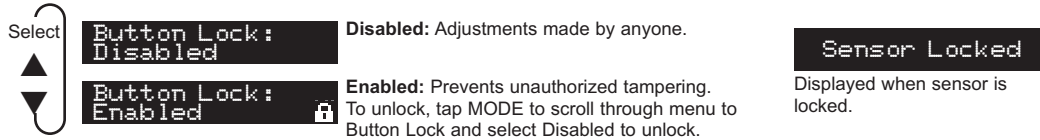

PARAMETER	Default	Default Setting Chart
AUTOSET MODE	Light-State	Other options: Dark-State, Midpoint Two-point, Dynamic, Window
AUTOSET PERCENT	20%	Other options: 10% - 50%
DETECT MODE	Light On	Other option: Dark On
RESPONSE TIME	Standard	Other options: High-Speed
HYSTERESIS	Standard	Other options: Low, High
ANTI-CROSSTALK	Disabled	Other options: Asynchronous Channel A, Asynchronous Channel B
TIMER	Bypass	Other options: Timer 1-19
TIMER DURATION	10ms	Other options: 0001 - 9999ms
OUTPUT TYPE	Classic	Other options: Redundant, Complementary, Single / Input, Single / Sync, Single / Reset
OUTPUT MODE		Other options: PNP - Source, NPN - Sink, Push/Pull
INPUT FUNCTIONS		Other options: Remote Set, Remote Command, Interrogate, Gate, Remote Dark On, Remote Lockout
INPUT MODE		Other options: Active High, Active Low
DISPLAY MODE	Numeric	Other options: Percentage, Numeric Flipped, Percentage Flipped
LOCK MODE	Disabled	Other option: Enabled

Factory Reset

Hold down MODE (■) on power up, then tap up or down (▲▼).
Sensor will return to all settings to factory default (see chart above).

Mounting on a DIN Rail

1. Hook the DIN rail clip on the bottom of the sensor under the edge of the DIN rail.
2. Gently push and pivot the sensor onto the DIN rail, pressing until it snaps into place.

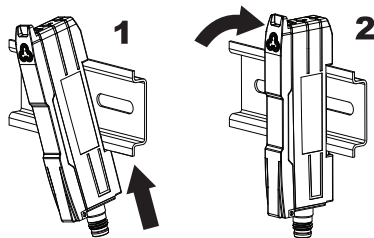

Installing the Fibers

1. Open the dust cover.
2. Move the fiber clamp forward to unlock it.
3. Insert the fiber(s) into the fiber port(s) until they stop.
4. Move the fiber clamp backward to secure the fiber(s).
5. Close the dust cover.

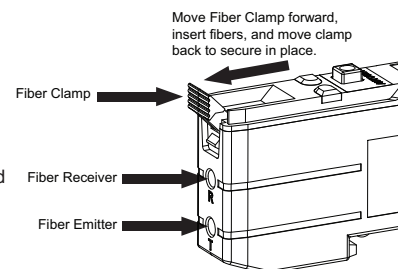

Remote Command Programming

In Remote Command Mode a limited set of options can be configured via the input wire. This is accomplished by sending a simple sequence of pulses on Q2 (white wire). For example, sending a sequence of two pulses followed by three pulse followed by two pulses selects dark on mode.

Example of 2 - 3 - 3 pulse command



Pulse width (P) is 40ms - 400ms.
The delay between sets of pulses (D) is 0.75 - 5 seconds.

Pulses are displayed while being received. Valid commands are executed immediately. Holding the input active will cancel a partial command.

AUTOSET

A single pulse command initiates an AUTOSET. A second single pulse command is required to complete Two-Point and Dynamic AUTOSETS.

Setting	Option	Icon	Pulse Sequence	Notes
AUTOSET			1	A single pulse initiates AUTOSET. An additional pulse command is required to complete AUTOSET for two-point and dynamic modes.
AUTOSET Mode	Light-State	LS	2 - 1 - 1	
	Dark-State	DS	2 - 1 - 2	
	Midpoint	MP	2 - 1 - 3	
	Two-Point	2P	2 - 1 - 4	
	Dynamic Set	DY	2 - 1 - 5	
	Window	WN	2 - 1 - 6	
AUTOSET Percent	10%	10%	2 - 2 - 4	Percentage will affect the next Light, Dark AUTOSET. Immediate effect on Window Size
	20%	20%	2 - 2 - 5	
	50%	50%	2 - 2 - 6	
Detect Mode	Light On	LO	2 - 3 - 1	
	Dark On	DO	2 - 3 - 2	
Response Time	High-Speed	HS	2 - 4 - 2	Anti-Crosstalk Disabled
	Standard	STD	2 - 4 - 3	
Hysteresis	Low	H0	2 - 5 - 1	
	Standard	H1	2 - 5 - 2	
	High	H2	2 - 5 - 3	
Anti-Crosstalk	Disabled		2 - 6 - 1	
	Async-Channel A	xA	2 - 6 - 2	
	Async-Channel B	xB	2 - 6 - 3	
Timer Function	Bypass		3 - 1 - 1	
	On-Delay		3 - 1 - 2	
	Off-Delay		3 - 1 - 3	
	One-Shot		3 - 1 - 4	
	Motion		3 - 1 - 5	
	On, Off-Delay		3 - 1 - 6	
	On, One-Shot		3 - 1 - 7	
	Off, One-Shot		3 - 1 - 8	
	Blind One-Shot		3 - 1 - 9	
	Delayed One-Shot		3 - 1 - 10	
	Stop, One-Shot		3 - 1 - 11	
Timer 1 Duration	1ms		3 - 2 - 1	
	2ms		3 - 2 - 2	
	5ms		3 - 2 - 3	
	10ms		3 - 2 - 4	
	20ms		3 - 2 - 5	
	50ms		3 - 2 - 6	
Timer 2 Duration	1ms		3 - 3 - 1	
	2ms		3 - 3 - 2	
	5ms		3 - 3 - 3	
	10ms		3 - 3 - 4	
	20ms		3 - 3 - 5	
	50ms		3 - 3 - 6	
Button Lock	Disabled		4 - 1 - 1	
	Enabled		4 - 1 - 2	
Display Mode	Numeric		4 - 2 - 1	
	Percentage		4 - 2 - 2	
	Numeric (Flipped)		4 - 2 - 3	
	Percentage (Flipped)		4 - 2 - 4	

Specifications

SUPPLY VOLTAGE & CURRENT

- 8-30 Vdc
- 28ma @ 24Vdc, 49ma @ 12Vdc
- Reverse polarity protected
- Transient spike protected

OUTPUT

- Configurable NPN, PNP or Push-Pull
- 150mA output current
- Short circuit & transient spike protected
- Saturation voltage: < 0.3Vdc @ 10mA < 2Vdc @ 150mA

INPUT

- Configurable active high/low
- Transient spike protected
- Configurable function: Remote setting or commands, Interrogate, Gate, Dark-On, Lockout, and Latch Reset.

POWER-UP DELAY

- 300ms. No output pulse on power-up.

RESPONSE TIME (Dependent on Mode)

- High-Speed (HS) 250µs
- Standard (STD) 1ms

REPEATABILITY (Dependent on Mode)

- HS (50µs)
- STD (100µs)

MAXIMUM RANGE (SWIR INFRARED)

Opposed Mode

- HS 8.5in (216mm)
- STD 10.0in (254mm)

Proximity Mode

- HS 1.6in (40.6mm)
- STD 2.0in (50.8mm)

When anti-crosstalk is enabled maximum range specifications are reduced 30%.

Note: Opposed tests utilized: MDF-B-36T

Proximity tests utilized: MDBF-E-36T

LIGHT IMMUNITY

- High immunity to most ambient light, including high efficiency lighting and high intensity strobes.

MUTUAL INTERFERENCE REJECTION

- Asynchronous: Two sensor max. responds to selected A or B Channel.

COMBINABLE DUAL TIMERS

- On-Delay, Off-Delay, One-Shot, Motion
- Latching function
- Timer range: 0.1 - 0.9ms, 1ms - 9,999ms

LED LIGHT SOURCE

- SWIR = 1460nm (Use glass fibers with Ø2.2mm connection only).

DISPLAY

- 96 X 16 white dot matrix OLED
- Display numerical range depended on processing mode
- HS - 2,047
- STD - 8,191 (default setting)

LED INDICATORS

- Output: Red LED. Illuminates when output is ON. Flashes when output is overloaded.
- Connector: Red LED, illuminates when input wire is activated.

CONNECTIONS

- M8, 4-pin
- Attached cable: 4-wire 6ft (1.8m)

OPERATING TEMPERATURE

- 5°C to 55°C (41°F to 131°F) - Electrical.

HOUSING CONSTRUCTION

- Chemical resistant, high-impact polycarbonate

RATINGS & CERTIFICATIONS

- IP50
- CE
- UL pending



RoHS Compliant

Product subject to change without notice

Dimensions

DFS61 Digital Fiber Optic Sensor

