

SP52Q LED Sports Lighter/Architectural Flood



Project Information	
Project Name: _____	Fixture Type: _____
Complete Catalog #: _____	Date: _____
Comments: _____	

The DuraGuard SP52 Sports Lighter and Architectural Flood luminaire is available in two wattages with specially designed optical systems to provide uniform light levels for sports applications and architectural highlighting. Four NEMA beam patterns provide optical distribution that is designed to replace HID lighting systems of 400W to 1500W MH or HPS. Typical sports applications include baseball, soccer, football, golf, motor vehicle tracks, tennis and outdoor recreation. Commercial flood light and accent lighting applications include retail centers, theme parks, schools and universities, public transit and airports, mid and high rise buildings and bridge structures. Mounting heights of up to 80 feet can be used based on light level and uniformity requirements.

SPECIFICATIONS AND FEATURES:

HOUSING:

Die Cast Aluminum Housing with Top Glare Shield, Integral Heat Sinking and Driver Compartment. Laser Aiming Bracket is Provided on the Top of the Housing. Heavy Duty Adjustable Yoke Allows for Pole Downward and Ground/Wall Upward Aiming. Nickel-Plated Stainless Steel Hardware.

LISTING & RATINGS:

CSA: Listed for Wet Locations, ANSI/UL 1598, 8750; IP66 Sealed LED Compartment.

FINISH:

Textured Architectural Gray Powdercoat Finish Over a Chromate Conversion Coating. Custom Colors Available Upon Request

LENS:

Clear One-Piece Molded ¼-Section Vandal-Resistant UV-Stabilized Polycarbonate Lenses in NEMA 2x2, 3x3, 4x4, and 5x5 Distributions. 4 Lenses Per Fixture, with Automatically Applied Closed Cell Gasketing.

MOUNTING OPTIONS:

Heavy Duty Yoke Allows for Aiming Horizontally and Vertically. Locking Bolts Can Be Configured for Up or Down Aiming. Adjustment Slots are Stamped With Embossed 5 Degree Increment Marks. Fixture is Supplied With 36" Cord and Liquid Tight Connector to Allow for Installation Without Opening the Housing to Make Circuit Connections. Yoke Can Be Bolted to Sports Lighting Cross Arms or Other Structures. Optional Tenon Mount Adaptor Available.

DURALED LED:

Aluminum Boards

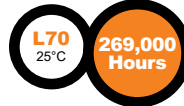

WATTAGE:

268w: Array: 268w, System: 294w (Up to 1000w HID Equivalent)
536w: Array: 536w, System: 588w (Up to 1500w HID Equivalent)

DRIVER:

Electronic Driver, 120-277V, 50/60Hz or 347-480V, 50/60Hz; Less Than 20% THD and PF>0.90. Standard Internal Surge Protection 6kV. 0-10V Dimming Standard for a Dimming Range of 100% to 10%; Dimming Source Current is 150 Microamps.

CONTROLS:

Fixtures Ordered with Optional Factory-Installed 5-wire Cord with 1-10V Dimming Conductors are Internally Wired for Downstream Switching and/or 1-10V Dimming Within the Housing. Dimming Response is a Function of the Driver Capability. Consult Factory for Driver Specification for 1-10V Specific Characteristics. Fixtures are NOT Designed for Use with Line Voltage Dimmers.

WARRANTY:

5-Year Warranty for -40°C to +50°C Environment.

See Page 2 for Projected Lumen Maintenance Table.

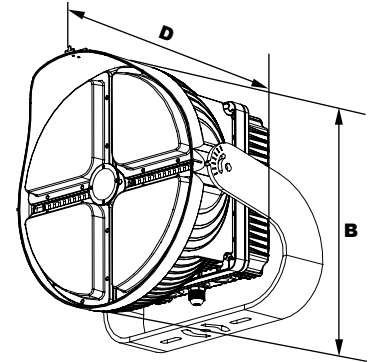

Dimensions

Length (D)	12 3/4" (323mm)
Height (B)	16" (405mm)

DuraLED TECHNOLOGY

Complete Units
Ordering Information
Example: SP52Q55536U5KGDF

SP52Q LED Sports Lighter/Architectural Flood

Model	Beam	Wattage	Driver	CCT	Color	Options
SP52Q = LED Sports Lighter/ Architectural Flood	22 =NEMA 2H x 2V 33 =NEMA 3H x 3V 44 =NEMA 4H x 4V 55 =NEMA 5H x 5V	268 =268w 536 =536w	U =120-277V H =347-480V	4K =4000K 5K =5000K	G =Gray C =Custom (Consult Factory)	

SF=Single Fuse (120-277V Only)
DF=Double Fuse (120-277V Only)
C53600B=3 Foot Black Cord, 600VAC, 5 Wire, Includes 1-10V Dimming Wires

*120-277V Models Only.



SP52Q LED Sports Lighter/Architectural Flood



ACCESSORIES & REPLACEMENT PARTS:



CVMAG

**Mounting Accessories
(Order Separately, Field Installed)**

CVMAG Die-Cast Adaptor for 2 3/8" Tenons, Gray Powdercoat Finish, Includes Hardware

PHOTOMETRIC PERFORMANCE

LED Board Watts	Drive Current (mA)	Input Watts	Beam	5000 CCT 80 CRI		4000 CCT 80 CRI	
				Lumens	LPW	Lumens	LPW
DuraLED 268w	2800	294	22 19°H x 15°V, NEMA 2H x 2V	30,323	104	29,446	103
			33 21°H x 21°V, NEMA 3H x 3V	31,283	106	31,006	106
			44 28°H x 27°V, NEMA 4H x 4V	32,799	112	32,008	109
			55 34°H x 33°V, NEMA 5H x 5V	32,942	112	31,873	108
DuraLED 536w	2800	588	22 19°H x 15°V, NEMA 2H x 2V	61,442	104	57,471	103
			33 16°H x 16°V, NEMA 3H x 3V	61,893	105	60,276	103
			44 31°H x 31°V, NEMA 4H x 4V	64,973	111	63,573	108
			55 38°H x 39°V, NEMA 5H x 5V	63,972	109	63,005	107

PROJECTED LUMEN MAINTENANCE

Data shown for 5000 CCT		Compare to MH				
TM-21-11	Input Watts	Initial	25,000 Hrs	50,000 Hrs	100,000 Hrs	Calculated LED Life
L70 Lumen Maintenance @ 25°C / 77°F	All wattages up to and including 588w	1.00	0.97	0.94	0.89	269,000
L70 Lumen Maintenance @ 50°C / 122°F		1.00	0.96	0.91	0.82	167,000
L80 Lumen Maintenance @ 40°C / 104°F		1.00	0.95	0.90	0.80	98,000

NOTES:

1. Projected per IESNA TM-21-11. Data references the extrapolated performance projections for the 2800mA base model in a 25°C ambient, based on 10,000 hours of LED testing per IESNA LM-80-08.
2. Compare to MH box indicates suggested Light Loss Factor (LLF) to be used when comparing to Metal Halide (MH) systems.

PHOTOMETRIC DATA

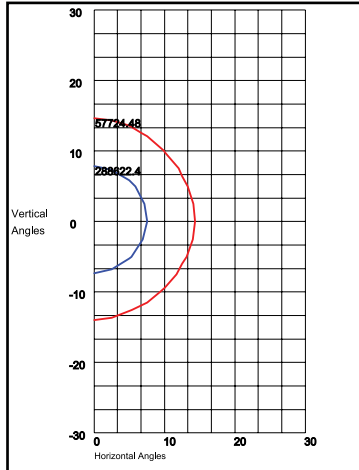

SP52Q22536U5K
 19°H x 15°V Beam, NEMA 2H x 2V
 All values shown for 536 watt, 5K model.

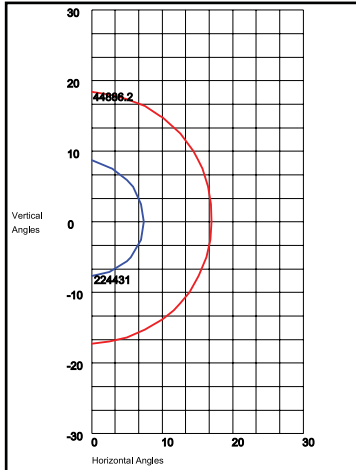

SP52Q33536U5K
 16°H x 16°V Beam, NEMA 3H x 3V

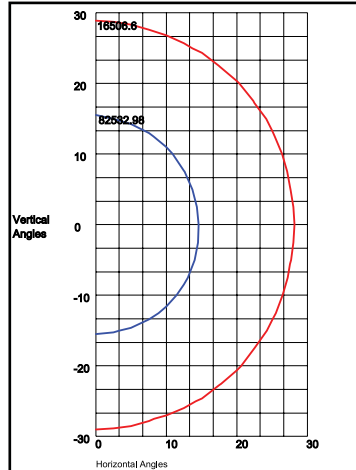

SP52Q44536U5K
 31°H x 31°V Beam, NEMA 4H x 4V

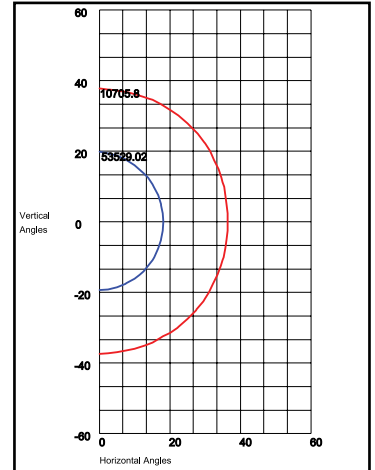

SP52Q55536U5K
 38°H x 39°V Beam, NEMA 5H x 5V

EPA (EFFECTIVE PROJECTED AREA) SHOWN WITH YOKE

Configuration	EPA (Sq. Ft.)	Weight (Lbs.)
	1.56	68 lbs

Specifications subject to change without notice.