

HARSH & HAZARDOUS ENVIRONMENT

Lighting Solutions



DuraGuard
PRODUCTS INC.®
A QSSI Company



DuraGuard Value Proposition

Your American Partner

With extensive inventory available in multiple U.S. locations, DuraGuard can deliver the lighting products your customers need—when they need them. Our products are always in stock and ready for fast delivery.



5 USA Manufacturing Locations

- Tampa, FL
- Cerritos, CA
- Memphis, TN
- Vancouver, WA
- Walden, NY

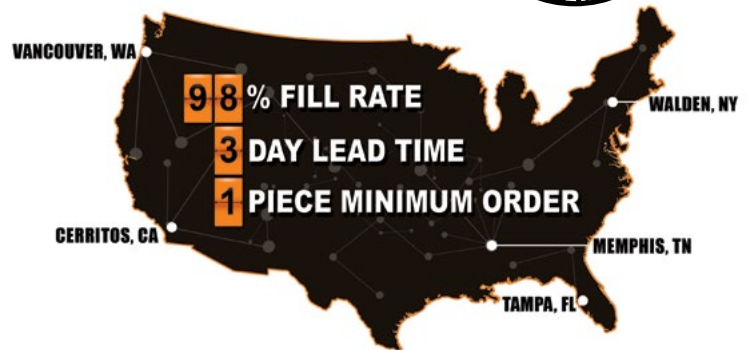

98-3-1 Rapid Ship

- 98% Fill Rate
- 3 Day Lead Time
- 1 Piece Minimum Order Quantity

Hazardous Lighting Guidelines

NEC/CEC Hazardous Location

DuraGuard offers Hazardous Location fixtures for Class 1, Division 2 environments Groups A, B, C and D. These products have been tested and certified to UL 844 through ETL for electrical installations in North America that are governed by the National Electrical Code (NEC) and Canadian Electrical Code (CEC).

Hazardous Location Classification Definitions:

Class I: Gases

Areas in which flammable gases or vapors are present in the air, in sufficient quantities to ignite or explode.

Division 2:

Not Normally Present Areas in which ignitable concentrations of hazards are normally in closed containers or closed systems. Hazards may be present due to accidental rupture or breakdown of such containers or systems.

Class I: Gases

- Group A - Acetylene
- Group B - Hydrogen
- Group C - Ethylene
- Group D - Propane



Hazardous Lighting Guidelines

C1D2 Hazardous Lighting

Class I, Division 2 - Enclosed and Gasketed

- Sealed to prevent the hazardous atmosphere from entering the fixture's interior
- Internal components engineered to radiate less heat
- "T" ratings are measured on the inside so that if a hazard is accidentally released into the atmosphere and reaches inside the luminaire, it will not ignite assuming the luminaire's "T" rating is below that of the hazard

APPLICATIONS

- Oil & Gas processing and storage
- Refining and Petrochemical
- Painting and finishing
- Concrete processing plants
- Tunnel Lighting



Harsh Environment Lighting

Harsh Environment - Enclosed and Gasketed

- IP66 Sealed to prevent water and contaminants from entering the fixture's interior
- UL 1598 Wet Location listed
- Hose down rated for pressure washing in dirty environments
- Heavy die cast aluminum housings with polycarbonate lenses for long life and durability

APPLICATIONS

- Heavy industrial applications
- Steel mills, steel fabrication
- Vehicle maintenance, repair and car wash
- Ship building and oil rig fabrication



C1D2 Hazardous Lighting HLP15 Series

LEDicated
Designed **SPECIFICALLY** for LED

EXPLOSION PROOF
C1D2
HAZARDOUS

Hazardous Location
LED Explosion Proof
Luminaire

64 Input Watts; 9,000 Lumens

L70
25°C

183,000
Hours



Flood Shown with
Adjustable Yoke

Shown
Suspended



Shown with
Ceiling Mount



Shown with 25° Stan-
chion Mount

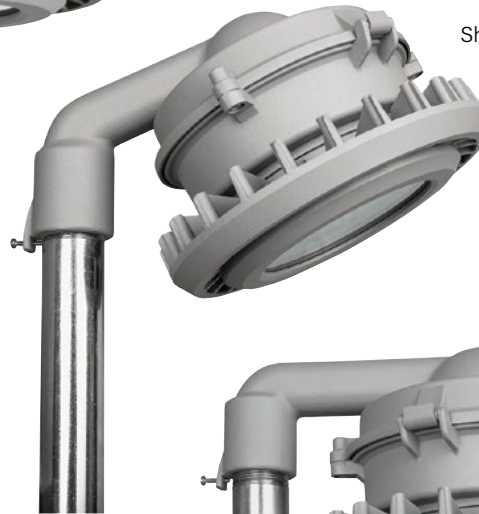

Shown with 90°
Wall Mount



Shown with 90°
Stanchion Mount



Shown with 25°
Wall Mount

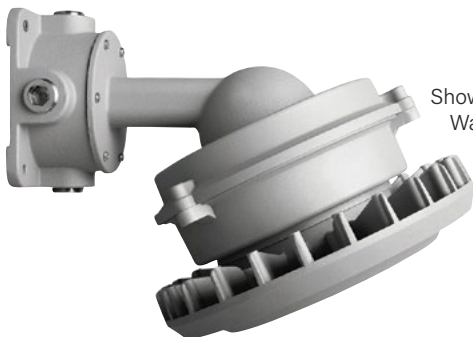

DuraGuard
www.duraguard.com



Class 1, Division 2
Groups A, B, C, D
T4 Temperature Rating

Suspended

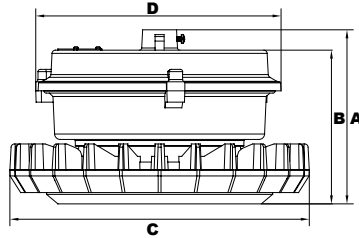

Dimensions

Height 1 (A)	6" (154mm)
Height 2 (B)	5¼" (136mm)
Diameter 1 (C)	10½" (265mm)
Diameter 2 (D)	8½" (217mm)

½" Hub

Complete Units
Ordering Information
Example: HLP15QF57U5KCGPSP

HLP15Q	F	57	U		C	G	P	
Model	Optics	Wattage	Driver	CCT	Lens	Color	Mount	Options
HLP15Q =DuraLED Hazardous Location Explosion Proof Luminaire	F =Wide	57 =57w	U =120-277V	4K =4000K 5K =5000K	C =Clear Tempered Glass Lens	G =Gray	P =Suspended (Conduit by Others)	SP =Surge Protection

Ceiling Mount

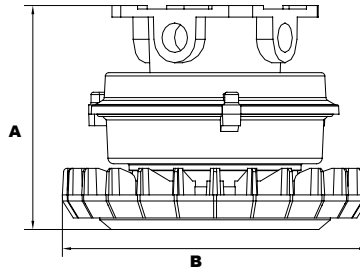

Dimensions

Height (A)	7¾" (194mm)
Diameter (B)	10½" (265mm)

¾" Entrance Plugs

Complete Units
Ordering Information
Example: HLP15QF57U5KCGCMSP

HLP15Q	F	57	U		C	G	CM	
Model	Optics	Wattage	Driver	CCT	Lens	Color	Mount	Options
HLP15Q =DuraLED Hazardous Location Explosion Proof Luminaire	F =Wide	57 =57w	U =120-277V	4K =4000K 5K =5000K	C =Clear Tempered Glass Lens	G =Gray	CM =Ceiling Mount	SP =Surge Protection

C1D2 Hazardous Lighting



HLP15Q Hazardous Location LED Explosion Proof Luminaire

64 Input Watts; 9,000 Lumens

Wall Mounts

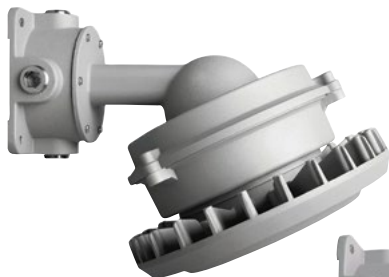

Shown with 25° Wall Mount

3/4" Entrance Plugs



Shown with 90° Wall Mount

25° Wall Mount

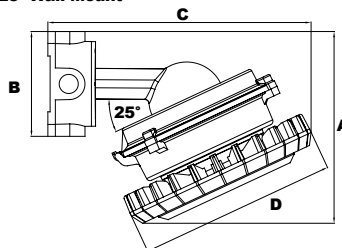

Dimensions

Height 1 (A)	10" (256mm)
Height 2 (B)	5½" (140mm)
Length (C)	13¾" (352mm)
Width (D)	10½" (265mm)

90° Wall Mount

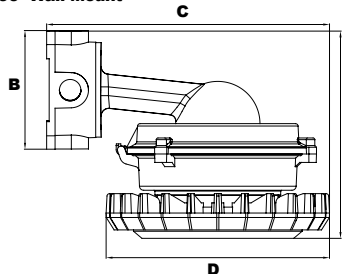

Dimensions

Height 1 (A)	9¼" (246mm)
Height 2 (B)	5½" (140mm)
Length (C)	13¾" (336mm)
Width (D)	10½" (265mm)

Complete Units
Ordering Information
Example: HLP15QF57U5KCGW25SP

HLP15Q	F	57	U		C	G		
Model	Optics	Wattage	Driver	CCT	Lens	Color	Mount	Options
HLP15Q=DuraLED Hazardous Location Explosion Proof Luminaire	F=Wide	57=57w	U=120-277V	4K=4000K 5K=5000K	C=Clear Tempered Glass Lens	G=Gray	W25=25° Wall Mount W90=90° Wall Mount	SP=Surge Protection

Stanchion Mounts



Shown with 25° Stanchion Mount

Mounts to 1¼" NPT



Shown with 90° Stanchion Mount

25° Stanchion

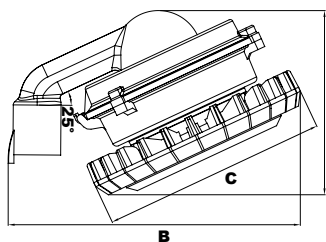

Dimensions

Height 1 (A)	8½" (216mm)
Length (B)	13½" (343mm)
Width (C)	10½" (265mm)

90° Stanchion

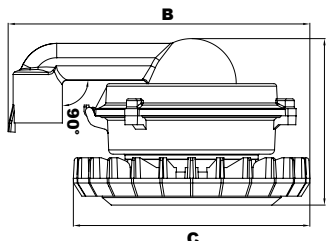

Dimensions

Height 1 (A)	7¼" (186mm)
Length (B)	13¾" (338mm)
Width (C)	10½" (265mm)

Complete Units
Ordering Information
Example: HLP15QF57U5KCGS25SP

HLP15Q	F	57	U		C	G		
Model	Optics	Wattage	Driver	CCT	Lens	Color	Mount	Options
HLP15Q=DuraLED Hazardous Location Explosion Proof Luminaire	F=Wide	57=57w	U=120-277V	4K=4000K 5K=5000K	C=Clear Tempered Glass Lens	G=Gray	S25=25° Stanchion S90=90° Stanchion	SP=Surge Protection

Flood



DuraGuard

**EXPLOSION PROOF
C1D2
HAZARDOUS**

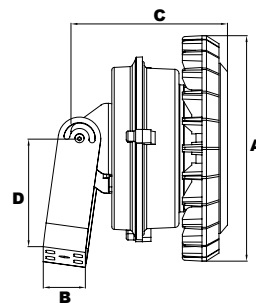

Dimensions

Height (A)	10½" (265mm)
Width (B)	2" (50mm)
Length 1 (C)	7¼" (184mm)
Length 2 (D)	5" (126mm)

Complete Units
Ordering Information
Example: HLP15QF57U5KCGYSP

HLP15Q	F	57	U		C	G	Y	
Model	Optics	Wattage	Driver	CCT	Lens	Color	Mount	Options
HLP15Q =DuraLED Hazardous Location Explosion Proof Luminaire	F =Wide	57 =57w	U =120-277V	4K =4000K 5K =5000K	C =Clear Tempered Glass Lens	G =Gray	Y =Adjustable Yoke	SP =Surge Protection



**Class 1, Division 2
Groups A, B, C, D
T4 Temperature Rating**

LEDicated
Designed **SPECIFICALLY** for LED



Photometric Performance

HLP15QF57U5KC-Clear Tempered Glass Lens

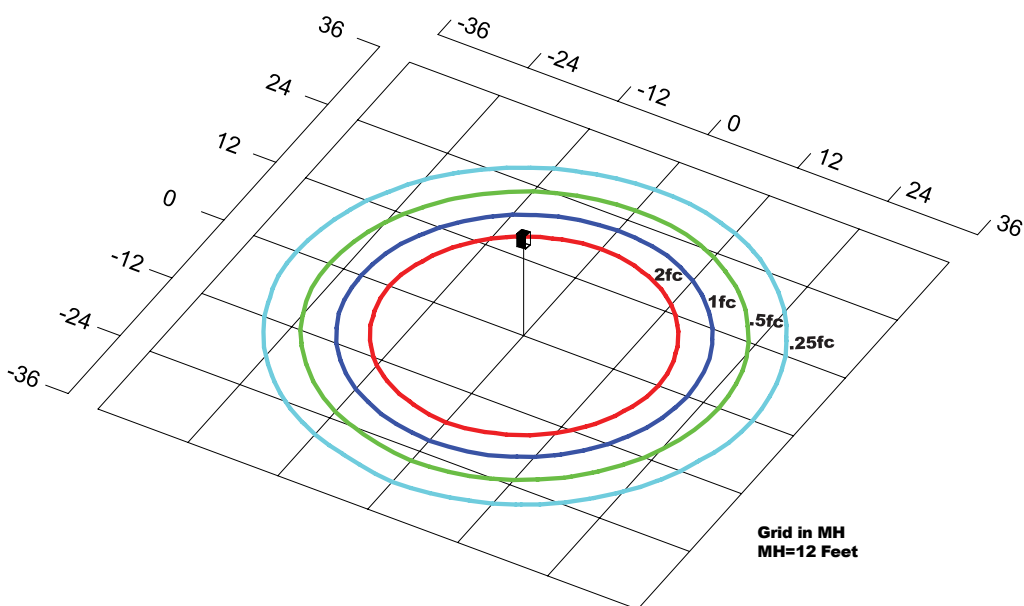
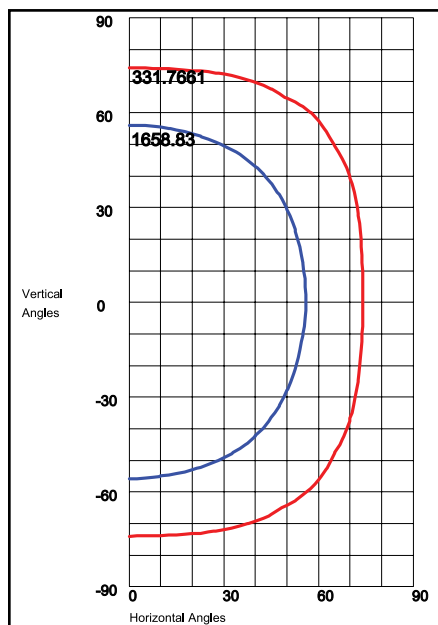

LED Board Watts	Drive Current (mA)	Input Watts	Optics	5000 CCT 80 CRI		4000 CCT 80 CRI	
				Lumens	LPW	Lumens	LPW
DuraLED 57w (Clear Lens)	175	64	F 110°H x 110°V, NEMA 7H x 7V	8,957	140	8,599	135

C1D2 Die Cast Linear Hazardous Lighting

HLVA Series

EXPLOSION PROOF
C1D2
HAZARDOUS

HLV1AQ Hazardous Location 12" Linear LED Die Cast

26-41 Input Watts; 2,280-5,600 Lumens; Replaces up to 175w HID

L70
25°C

187,000
Hours

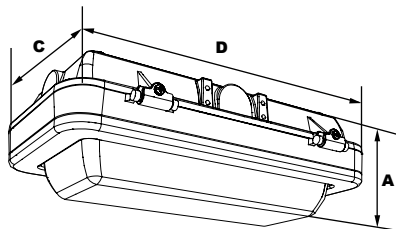

Dimensions

Width (D)	12½" (309mm)
Length (C)	7" (178mm)
Height (A)	HLV1AOQ: 4" (102mm) HLV1AHQ: 4¼" (107mm) HLV1AVQ: 4¼" (107mm)

Complete Units
Ordering Information
Example: HLVAOQF37U5KCP

Model	F Optics	Wattage	U Driver	CCT	Lens	Color
HLV1AOQ =DuraLED Open Frame 12" Linear LED Die Cast	F =Wide	22 =22w 37 =37w	U =120-277V	4K =4000K 5K =5000K	C =Clear UV-Stabilized Polycarbonate Vandal-Resistant Lens L =SoftLED LumaLens Opal UV-Stabilized Polycarbonate Vandal-Resistant Lens	P =Platinum C =Custom (Consult Factory)
HLV1AHQ =DuraLED Horizontal Hood 12" Linear LED Die Cast						
HLV1AVQ =DuraLED Vertical Hood 12" Linear LED Die Cast						

Accessories



HLV2AQ Hazardous Location 24" Linear LED Die Cast

58-77 Input Watts; 5,700-10,300 Lumens; Replaces up to 250w HID

L70
25°C

138,000
Hours

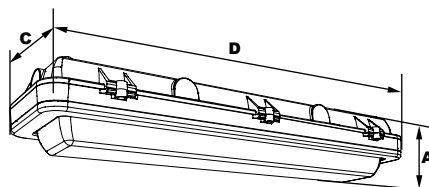

Dimensions

Width (D)	24½" (614mm)
Length (C)	7" (178mm)
Height (A)	4" (102mm)

Complete Units
Ordering Information
Example: HLVAOQF66U5KCP

HLV2AQ	F Optics	Wattage	Driver	CCT	Lens	Color
HLV2AOQ =DuraLED Open Frame 24" Linear LED Die Cast	F =Wide	47 =47w 66 =66w	U =120-277V H =347-480V	4K =4000K 5K =5000K	C =Clear UV-Stabilized Polycarbonate Vandal-Resistant Lens L =SoftLED LumaLens Opal UV-Stabilized Polycarbonate Vandal-Resistant Lens	P =Platinum C =Custom (Consult Factory)

Accessories





HLV4AQ Hazardous Location 48" Linear LED Die Cast

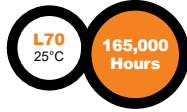

123-152 Input Watts; 13,500-20,000 Lumens; Replaces up to 400w HID

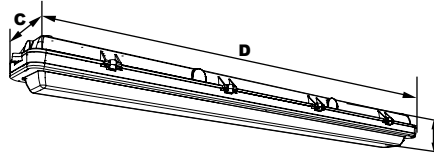

Dimensions

Width (D)	49" (1,247mm)
Length (C)	7" (178mm)
Height (A)	4" (102mm)

Complete Units
Ordering Information
Example: HLVA4OQF136U5KCP

HLVAOQ	F					
Model	Optics	Wattage	Driver	CCT	Lens	Color
HLV2AOQ =DuraLED Open Frame 24" Linear LED Die Cast	F =Wide	112 =112w 136 =136w	U =120-277V H =347-480V	4K =4000K 5K =5000K	C =Clear UV-Stabilized Polycarbonate Vandal-Resistant Lens L =SoftLED LumaLens Opal UV-Stabilized Polycarbonate Vandal-Resistant Lens	P =Platinum C =Custom (Consult Factory)

Accessories

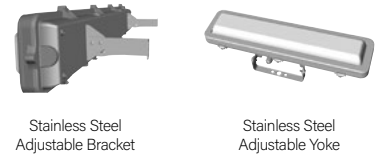

Class 1, Division 2
Groups A, B, C, D
T4 Temperature Rating



Photometric Performance

HLV1AQ Clear Lens

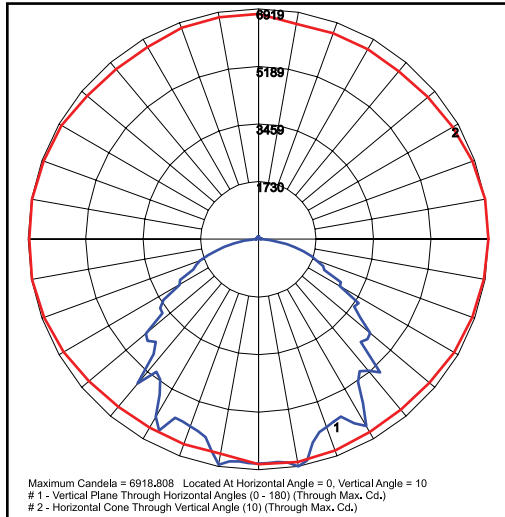

HLV2AQ Clear Lens

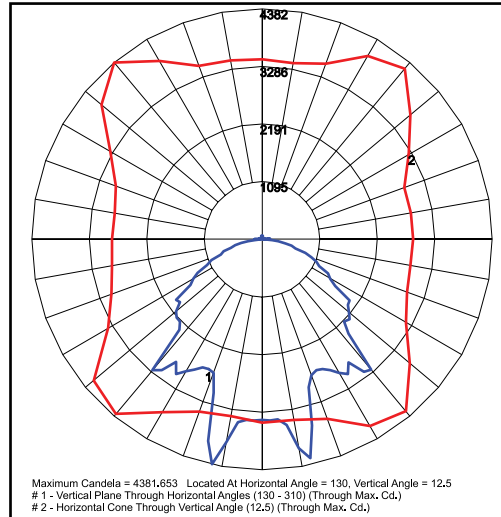

HLV4AQ LumaLens

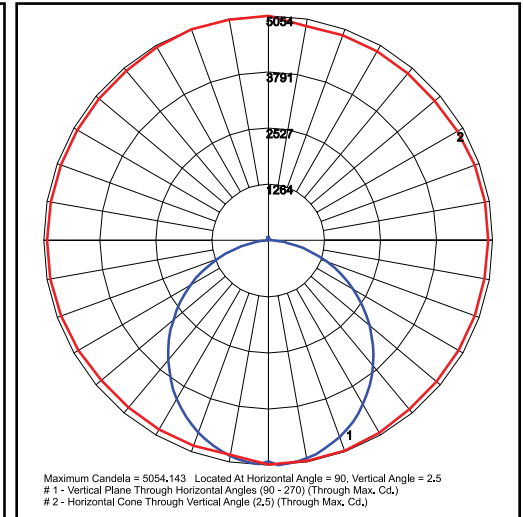



C1D2 Hazardous Flood Lighting

HLF25Q Series

EXPLOSION PROOF
C1D2
HAZARDOUS

HLF25 SERIES ORDERING GUIDE

HLF25Q Hazardous Location LED Explosion Proof Flood

140 Input Watts; 15,000 Lumens

L70
25°C

385,000
Hours

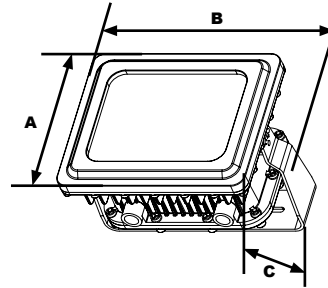

Dimensions

Height (A)	10 1/4" (273mm)
Width (B)	13 3/4" (348mm)
Length (C)	9 1/4" (248mm)



Class 1, Division 2
Groups A, B, C, D
T4 Temperature Rating

LEDicated
Designed **SPECIFICALLY** for LED

HLF25Q	F	132	U	C	G	Y		
Model	Optics	Wattage	Driver	CCT	Lens	Color	Mount	Options
HFL25Q =DuraLED Horizontal Flood Light	F =110°H x 110°V, NEMA 7H x 7V	132 =132w	U =120-277V	4K =4000K 5K =5000K	C =Clear Tempered Glass Lens	G =Gray	Y =Adjustable Yoke	SP =Surge Protection

Photometric Performance

HLF25QF132U5KC-Clear Tempered Glass Lens

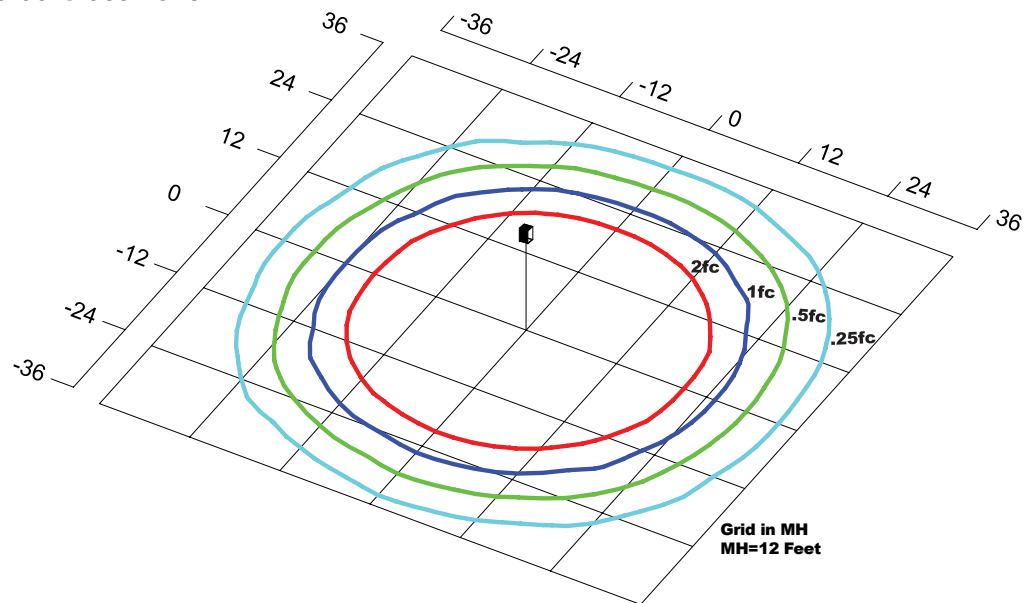
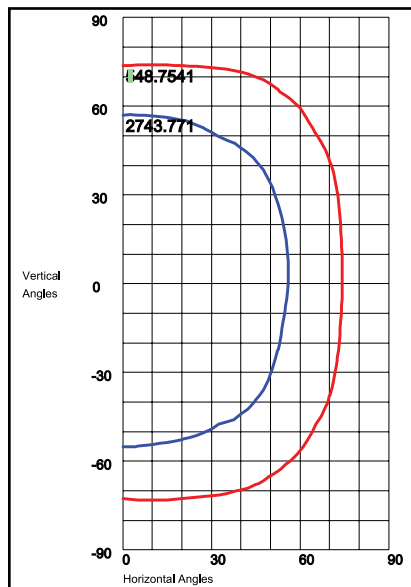

LED Board Watts	Drive Current (mA)	Input Watts	Beam	5000 CCT 80 CRI		4000 CCT 80 CRI		
				Lumens	LPW	Lumens	LPW	
DuraLED 68w	525	75	F	100°H x 110°V, NEMA 7H x 7V	7,401	99	6,772	90

Harsh Environment Vaporproof Lighting



VAPORPROOF SERIES ORDERING GUIDE

LEDicated Vaporproof

27 Input Watts; 2,510-3,390 Lumens; Replaces up to 175w HID

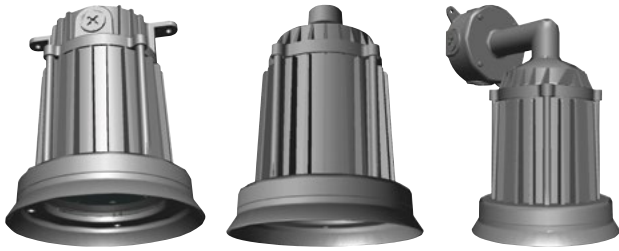
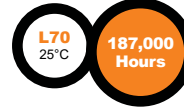

VB53Q

VP53Q

VW53Q

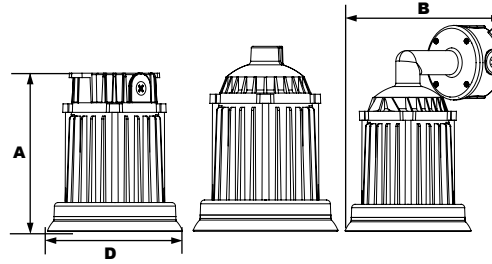

Dimensions

Diameter (D)	7¼" (184mm)
Height (A)	VP53Q: 9¼" (235mm) VB53Q: 8½" (216mm) VW53Q: 12" (305mm)
Depth (B)	8¾" (225mm)

Complete Units
Ordering Information
Example: VP53QF1X23U5KPSF

Model	F	1X23	U	CCT	Color	Options
Model	Optics	Wattage	Driver	CCT	Color	Options
VB53Q =DuraLED LEDicated Box Mount Vaporproof VP53Q =DuraLED LEDicated Pendant Mount Vaporproof VW53Q =DuraLED LEDicated Wall Mount Vaporproof	F=Type V	1X23=23w	U=120-277V	4K=4000K 5K=5000K	P=Platinum C=Custom (Consult Factory)	See Spec Pages for Options Ordering Logic

Classic LED Vaporproof

13 Input Watts; 810-840 Lumens; Replaces up to 70w HID

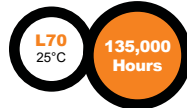

VB43Q

VW43Q

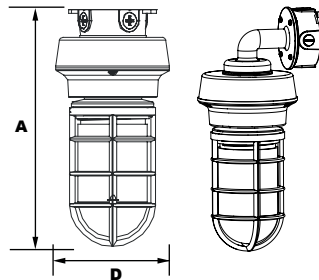

Dimensions

Diameter (D)	7¼" (181mm)
Height (A)	AIVB43 15" (381mm) AIVW43 18¼" (464mm)

Complete Units
Ordering Information
Example: VB43QF1X10U5KGSF

Model	F	1X10	U	CCT	Color	Options
Model	Optics	Wattage	Driver	CCT	Color	Options
VB43Q =DuraLED Large Box Mount Vaporproof VW43Q =DuraLED Large Wall Mount Vaporproof	F=Type V	1X10=10w	U=120-277V	4K=4000K 5K=5000K	G=Gray C=Custom (Consult Factory)	See Spec Pages for Options Ordering Logic

Harsh Environment Vaporproof Lighting Accessories



*Shown Mounted



Die Cast Linear Harsh Environment Lighting

LVA Series

LV1AQ Harsh Environment 12" Linear LED Die Cast

26-41 Input Watts; 2,280-5,600 Lumens; Replaces up to 175w HID

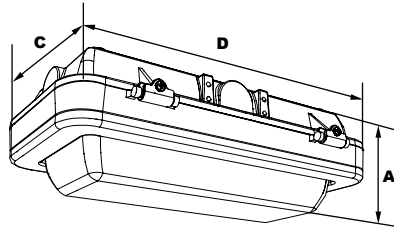
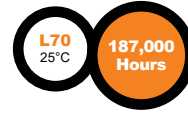

Dimensions

Width (D)	12½" (309mm)
Length (C)	7" (178mm)
Height (A)	LV1AOQ: 4" (102mm) LV1AHQ: 4¼" (107mm) LV1AVQ: 4¼" (107mm)

Complete Units
Ordering Information
Example: LV1AOQF37U5KCP

	F		U			
Model	Optics	Wattage	Driver	CCT	Lens	Color
LV1AOQ =DuraLED Open Frame 12" Linear LED Die Cast	F =Wide	22 =22w 37 =37w	U =120-277V	4K =4000K 5K =5000K	C =Clear UV-Stabilized Polycarbonate Vandal-Resistant Lens L =SoftLED LumaLens Opal UV-Stabilized Polycarbonate Vandal-Resistant Lens	P =Platinum C =Custom (Consult Factory)
LV1AHQ =DuraLED Horizontal Hood 12" Linear LED Die Cast						
LV1AVQ =DuraLED Vertical Hood 12" Linear LED Die Cast						

Accessories

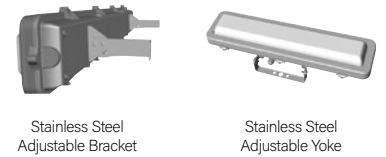

LV2AQ Harsh Environment 24" Linear LED Die Cast

58-77 Input Watts; 5,700-10,300 Lumens; Replaces up to 250w HID

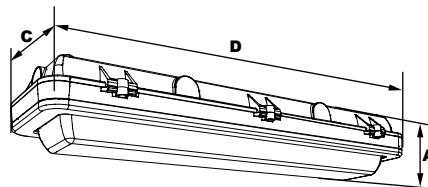
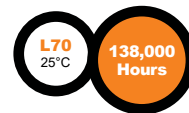

Dimensions

Width (D)	24½" (614mm)
Length (C)	7" (178mm)
Height (A)	4" (102mm)

Complete Units
Ordering Information
Example: LV2AOQF66U5KCP

LV2AQ	F					
Model	Optics	Wattage	Driver	CCT	Lens	Color
LV2AOQ =LED Open Frame 24" Linear LED Die Cast	F =Wide	47 =47w 66 =66w	U =120-277V H =347-480V	4K =4000K 5K =5000K	C =Clear UV-Stabilized Polycarbonate Vandal-Resistant Lens L =SoftLED LumaLens Opal UV-Stabilized Polycarbonate Vandal-Resistant Lens	P =Platinum C =Custom (Consult Factory)

Accessories

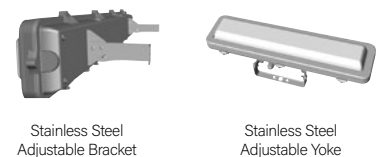

LV4AQ Harsh Environment 48" Linear LED Die Cast

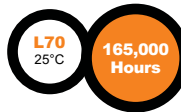

123-152 Input Watts; 13,500-20,000 Lumens; Replaces up to 400w HID

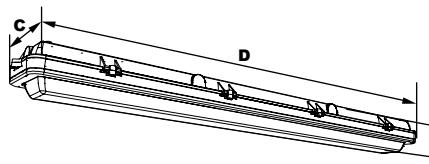

Dimensions	
Width (D)	49" (1,247mm)
Length (C)	7" (178mm)
Height (A)	4" (102mm)

Complete Units
Ordering Information
Example: LV4AQF136U5KCP

LVAOQ	F					
Model	Optics	Wattage	Driver	CCT	Lens	Color
LV2AQ =DuraLED Open Frame 24" Linear LED Die Cast	F =Wide	112 =112w 136 =136w	U =120-277V H =347-480V	4K =4000K 5K =5000K	C =Clear UV-Stabilized Polycarbonate Vandal-Resistant Lens L =SoftLED LumaLens Opal UV-Stabilized Polycarbonate Vandal-Resistant Lens	P =Platinum C =Custom (Consult Factory)

Accessories

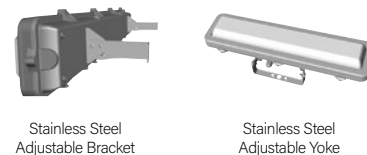

Photometric Performance

LV1AQ Clear Lens

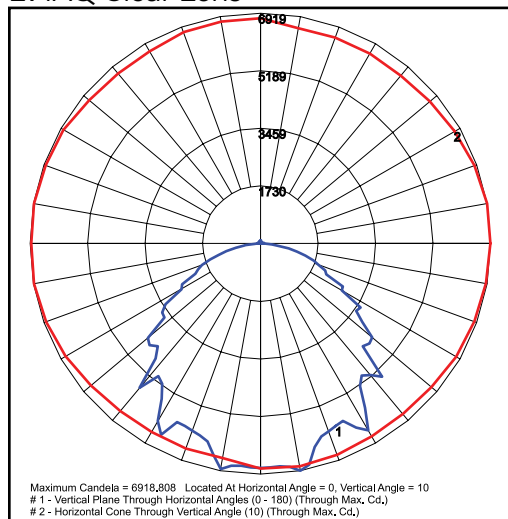

LV2AQ Clear Lens

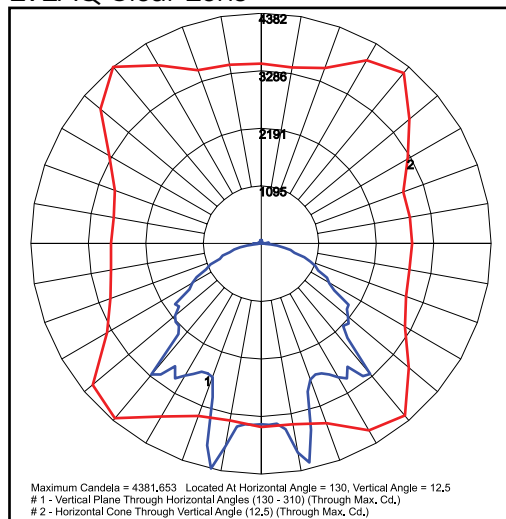

LV4AQ LumaLens

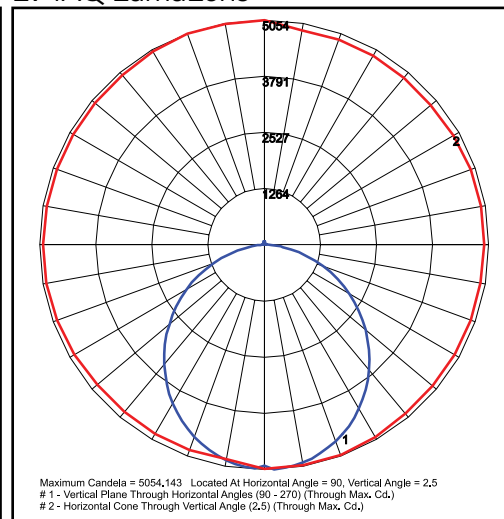

Harsh Environment Low Profile Luminaires

VN34Q Low Profile Medium Surface Mount

27 Input Watts; 2,780-2,890 Lumens; Replaces up to 100w HID

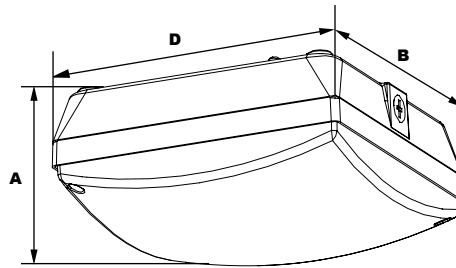
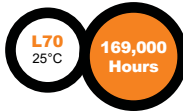

Dimensions	
Width (D)	9" (229mm)
Length (B)	9" (229mm)
Height (A)	4" (102mm)

Complete Units
Ordering Information
Example: VN34QF1X23U5KLPZSP

VN34Q	F	1X23			LP		
Model	Optics	Wattage	Driver	CCT	Lens	Color	Options
VN34Q=DuraLED Low Profile Medium Surface Mount	F=Type V	1X23=23w	U=120-277V H=347-480V	4K=4000K 5K=5000K	LP=SoftLED Low Profile LumaLens Opal UV-Stabilized Polycarbonate Lens	Z=Bronze C=Custom (Consult Factory)	See Spec Pages for Options Ordering Logic

VN44Q Low Profile Large Medium Surface Mount

54 Input Watts; 5,500-5,800 Lumens; Replaces up to 175w HID

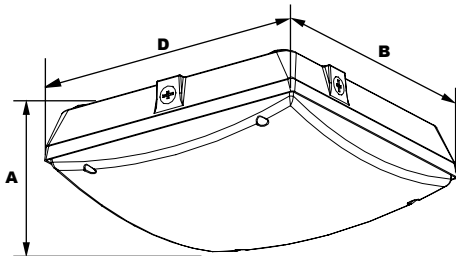
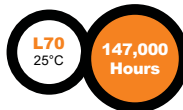

Dimensions	
Width (D)	12½" (315mm)
Length (B)	12½" (315mm)
Height (A)	4¼" (106mm)

Complete Units
Ordering Information
Example: VN44QF1X45U5KLPZSP

VN44Q	F	1X45			LP		
Model	Optics	Wattage	Driver	CCT	Lens	Color	Options
VN44Q=DuraLED Low Profile Large Surface Mount	F=Type V	1X45=45w	U=120-277V H=347-480V	4K=4000K 5K=5000K	LP=SoftLED Low Profile LumaLens Opal UV-Stabilized Polycarbonate Lens	Z=Bronze C=Custom (Consult Factory)	See Spec Pages for Options Ordering Logic

VNR34Q LED Low Profile Round Surface Mount

39 Input Watts; 4,600-4,800 Lumens; Replaces up to 100w HID

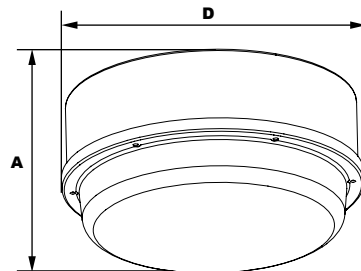
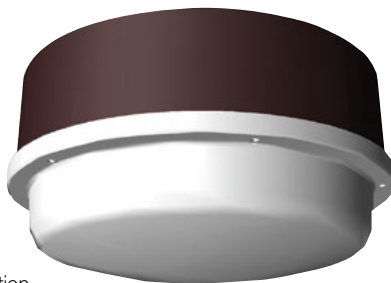

Dimensions	
Diameter (D)	11½" (291mm)
Height (A)	6" (150mm)

Complete Units
Ordering Information
Example: VNR34QF1X34U5KLPZSP

VNR34Q	F	1X34			LP		
Model	Optics	Wattage	Driver	CCT	Lens	Color	Options
VNR34Q=DuraLED Low Profile Round Surface Mount	F=Type V	1X34=34w	U=120-277V H=347-480V	4K=4000K 5K=5000K	LP=SoftLED Low Profile LumaLens Opal UV-Stabilized Polycarbonate Lens	Z=Bronze C=Custom (Consult Factory)	See Spec Pages for Options Ordering Logic

Wet Location Hose Down Linear Non-Metallic Luminaires

LVP Linear LED Vaportight

21-42 Input Watts; 2,000-4,000 Lumens; Replaces up to 100w HID

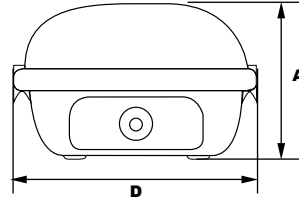
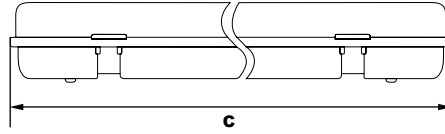

LV2PS21 Dimensions

Width (D)	6½" (165mm)
Length (C)	50" (1270mm)
Height (A)	4" (102mm)

LV4PS42 Dimensions

Width (D)	6½" (165mm)
Length (C)	50" (1270mm)
Height (A)	4" (102mm)

Model	Driver	5K	G	Options
LV2PS21=2' Linear LED Vaportight	U=120-277V	5K=5000K	G=Gray	See Spec Pages for Options Ordering Logic
LV4PS42=4' Linear LED Vaportight	C=347V*			

*LV4PS42 Only

Linear LED Vaportight Accessories



CONTROLLED WITH *WattStopper*
Wattstopper Passive Infrared Occupancy Sensor



AG2Q LED AquaGuard

52 Input Watts; 6,900 Lumens; Wet Locations

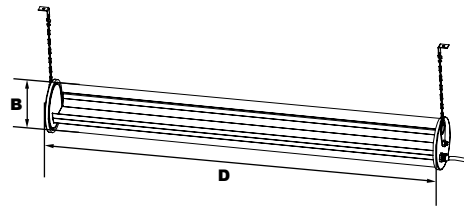
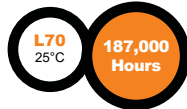

Dimensions

Diameter (D)	6¼" (169mm)
Length (B)	48¼" (1,227mm)

Complete Units
Ordering Information
Example: AG24QF1X47U5KWSF



AG2	4QF1X47	U	5K	W	Options
Model	Length/Optic/Wattage	Driver	CCT	Color	Options
AG2=DuraLED AquaGuard	4QF1X47=4 Feet, 47w	U=120-277V	5K=5000K	W=White	See Spec Pages for Options Ordering Logic



Your American Partner

With extensive inventory available in multiple U.S. locations, DuraGuard can deliver the lighting products your customers need—when they need them. Our products are always in stock and ready for fast delivery.

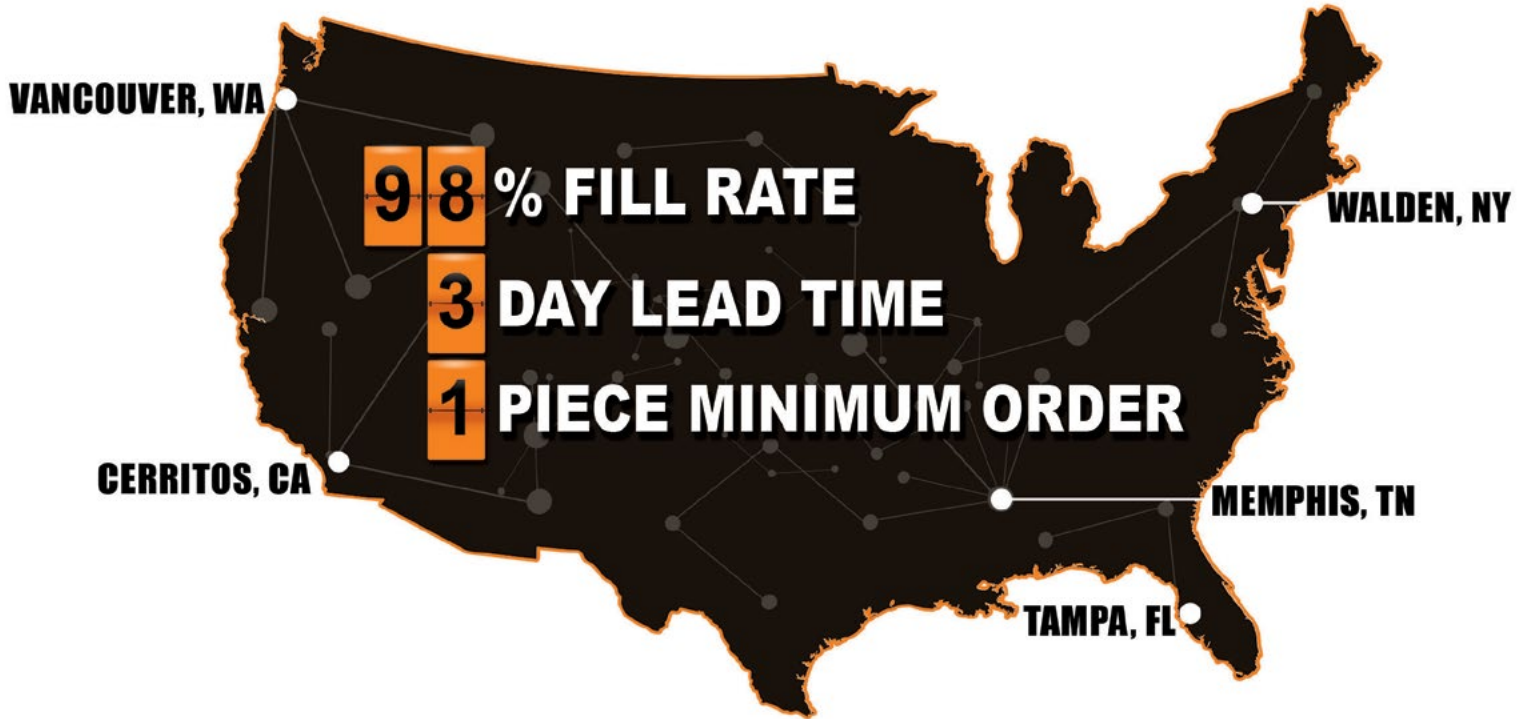

5 USA Manufacturing Locations

- Tampa, FL
- Cerritos, CA
- Memphis, TN
- Vancouver, WA
- Walden, NY



DuraGuard
PRODUCTS INC.[®]
A QSSI Company

12802 Commodity PL
Tampa, FL 33626
Phone: 800-736-7991
customerservice@duraguard.com
www.duraguard.com

