

## Technical data sheet Stationary bar code reader

Part no.: 50138074

BCL 300i R1 J 100 D H

### Contents

- Technical data
- Dimensioned drawings
- Electrical connection
- Diagrams
- Operation and display
- Part number code
- Notes
- Accessories



Figure can vary



**RS232**

**RS422**



## Technical data

### Basic data

Series	BCL 300i
--------	----------

### Special version

Special version	Heating
-----------------	---------

### Functions

Functions	Alignment mode
	AutoConfig
	AutoControl
	AutoReflAct
	Code fragment technology
	Heating
	LED indicator
	Reference code comparison

### Characteristic parameters

MTTF	110 years
------	-----------

### Read data

Code types, readable	2/5 Interleaved
	Codabar
	Code 128
	Code 39
	Code 93
	EAN 8/13
	GS1 Databar Expanded
	GS1 Databar Limited
	GS1 Databar Omnidirectional
	UPC
Scanning rate, typical	1,000 scans/s
Bar codes per reading gate, max. number	64 Piece(s)

### Optical data

Reading distance	100 ... 600 mm
Light source	Laser, Red
Wavelength	655 nm
Laser class	1, IEC/EN 60825-1:2014
Transmitted-signal shape	Continuous
Usable opening angle (reading field opening)	60 °
Modulus size	0.5 ... 0.8 mm
Reading method	Raster scanner with deflecting mirror
Beam deflection	By means of rotating polygon mirror wheel + deflecting mirror
Light beam exit	Lateral with deflecting mirror
Raster (number of lines)	8 Piece(s)
Scanning field at scanner distance of 100 mm	17 mm
Scanning field at scanner distance of 200 mm	27 mm
Scanning field at scanner distance of 300 mm	38 mm
Scanning field at scanner distance of 400 mm	48 mm

### Electrical data

Protective circuit	Polarity reversal protection
--------------------	------------------------------

### Performance data

Supply voltage $U_B$	18 ... 30 V, DC
Power consumption, max.	27 W

### Inputs/outputs selectable

Output current, max.	60 mA
Number of inputs/outputs selectable	2 Piece(s)
Input current, max.	8 mA

### Interface

Type	RS 232, RS 422
------	----------------

#### RS 232

Function	Process
Transmission speed	4,800 ... 115,200 Bd
Data format	Adjustable
Start bit	1
Data bit	7,8
Stop bit	1.2
Parity	Adjustable
Transmission protocol	<STX><data><CR><LF>
Data encoding	ASCII

#### RS 422

Function	Process
Transmission speed	4,800 ... 115,200 Bd
Data format	Adjustable
Start bit	1
Data bit	7, 8 data bits
Stop bit	1, 2 stop bits
Transmission protocol	Adjustable
Data encoding	ASCII

### Service interface

Type	USB 2.0
------	---------

#### USB

Function	Configuration via software
----------	----------------------------

### Connection

Number of connections	1 Piece(s)
-----------------------	------------

#### Connection 1

Function	BUS OUT
	Connection to device
	Data interface
	PWR / SW IN / OUT
	Service interface

**Type of connection** Plug connector, It is essential to use a connection unit when commissioning the device.

No. of pins	32 -pin
Type	Male

## Technical data

### Mechanical data

Design	Cubic
Dimension (W x H x L)	103 mm x 44 mm x 96 mm
Housing material	Metal
Metal housing	Diecast aluminum
Lens cover material	Glass
Net weight	350 g
Housing color	Red Silver
Type of fastening	Dovetail grooves Fastening on back Via optional mounting device

### Operation and display

Type of display	LED Monochromatic graphic display, 128 x 32 pixels
Number of LEDs	2 Piece(s)
Type of configuration	Via web browser

### Environmental data

Ambient temperature, operation	-35 ... 40 °C
Ambient temperature, storage	-20 ... 70 °C
Relative humidity (non-condensing)	0 ... 90 %

### Certifications

Degree of protection	IP 65
Protection class	III
Certifications	c UL US
Test procedure for EMC in accordance with standard	EN 55022 EN 61000-4-2, -3, -4, -6
Test procedure for shock in accordance with standard	IEC 60068-2-27, test Ea
Test procedure for continuous shock in accordance with standard	IEC 60068-2-29, test Eb
Test procedure for vibration in accordance with standard	IEC 60068-2-6, test Fc

### Classification

Customs tariff number	84719000
ECLASS 5.1.4	27280102
ECLASS 8.0	27280102
ECLASS 9.0	27280102
ECLASS 10.0	27280102
ECLASS 11.0	27280102
ECLASS 12.0	27280102
ECLASS 13.0	27280102
ETIM 5.0	EC002550
ETIM 6.0	EC002550
ETIM 7.0	EC002550
ETIM 8.0	EC002550

# Dimensioned drawings

All dimensions in millimeters

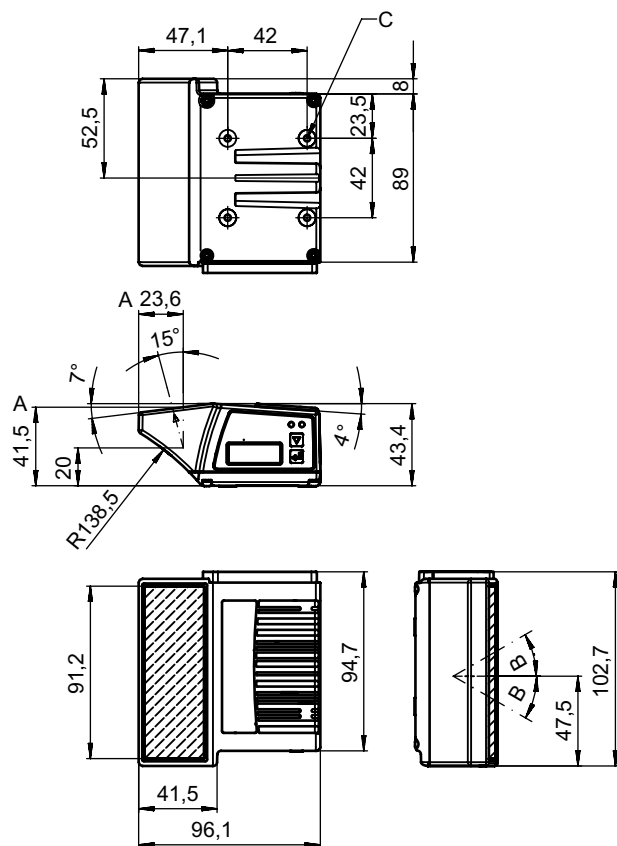

- A Optical axis
- B Deflection angle of the laser beam:  $\pm 30^\circ$
- C M4 thread (5 mm deep)

## Electrical connection

### Connection 1

<b>Function</b>	BUS OUT Connection to device Data interface PWR / SW IN / OUT Service interface
<b>Type of connection</b>	Plug connector
<b>Type of connection</b>	It is essential to use a connection unit when commissioning the device.
<b>No. of pins</b>	32 -pin
<b>Type</b>	Male

# Diagrams

## Reading field curve



x Reading field distance [mm]  
 y Reading field width [mm]

## Operation and display

LED	Display	Meaning
1 PWR	Green, flashing	Device ok, initialization phase
	Green, continuous light	Device OK
	Green, briefly off - on	Reading successful
	Green, briefly off - briefly red - on	Reading not successful
	Orange, continuous light	Service mode
	Red, flashing	Device OK, warning set
	Red, continuous light	Error, device error
	2 NET	Green, flashing
Green, continuous light		Bus operation ok
Red, flashing		Communication error
Red, continuous light		Bus error

# Part number code

Part designation: **BCL XXXX YYZ AAA BB CCCC**

<b>BCL</b>	<b>Operating principle</b> BCL: bar code reader
<b>XXXX</b>	<b>Series/interface (integrated fieldbus technology)</b> 300i: RS 232 / RS 422 (stand-alone) 301i: RS 485 (multiNet slave) 304i: PROFIBUS DP 308i: EtherNet TCP/IP, UDP 338i: EtherCAT 348i: PROFINET RT 358i: EtherNet/IP
<b>YY</b>	<b>Scanning principle</b> S: line scanner (single line) R1: line scanner (raster) O: oscillating-mirror scanner (oscillating mirror)
<b>Z</b>	<b>Optics</b> N: High Density (close) M: Medium Density (medium distance) F: Low Density (remote) L: Long Range (very large distances) J: ink-jet (depending on the application)
<b>AAA</b>	<b>Beam exit</b> 100: lateral 102: front
<b>BB</b>	<b>Special equipment</b> D: With display H: With heating DH: optionally with display and heating P: plastic exit window
<b>CCCC</b>	<b>Functions</b> F007: optimized process data structure F099: OPC-UA function

**Note**



↪ A list with all available device types can be found on the Leuze website at [www.leuze.com](http://www.leuze.com).

## Notes

 **Observe intended use!**



- ↪ This product is not a safety sensor and is not intended as personnel protection.
- ↪ The product may only be put into operation by competent persons.
- ↪ Only use the product in accordance with its intended use.

 **ATTENTION! LASER RADIATION – CLASS 1 LASER PRODUCT**



The device satisfies the requirements of IEC/EN 60825-1:2014 safety regulations for a product of **laser class 1** and complies with 21 CFR 1040.10 except for conformance with IEC 60825-1 Ed. 3., as described in Laser Notice No. 56, dated May 8, 2019.

- ↪ Observe the applicable statutory and local laser protection regulations.
- ↪ The device must not be tampered with and must not be changed in any way.  
There are no user-serviceable parts inside the device.  
Repairs must only be performed by Leuze electronic GmbH + Co. KG.

## Accessories



### Connection technology - Connection unit

	Part no.	Designation	Article	Description
	50114369	MA 100	Modular connection unit	Interface: RS 232, RS 485 Connections: 1 Piece(s) Degree of protection: IP 54

### Connection technology - Connection cables



	Part no.	Designation	Article	Description
	50132079	KD U-M12-5A-V1-050	Connection cable	Connection 1: Connector, M12, Axial, Female, A-coded, 5 -pin Connector, LED: No Connection 2: Open end Shielded: No Cable length: 5.000 mm Sheathing material: PVC

### Connection technology - Interconnection cables

	Part no.	Designation	Article	Description
	50114571 *	KB 301-3000	Interconnection cable	Suitable for interface: RS 232, RS 422, RS 485 Connection 1: Socket connector Connection 2: JST ZHR, 10 -pin, 6 -pin Shielded: Yes Cable length: 3,000 mm Sheathing material: PVC
	50117011	KB USB A - USB miniB	Service line	Suitable for interface: USB Connection 1: USB Connection 2: USB Shielded: Yes Cable length: 1,500 mm Sheathing material: PVC

\* Necessary accessories, please order separately

### Connection technology - Connection boxes

	Part no.	Designation	Article	Description
	50116463 *	MK 300	Connection unit	Suitable for: BCL 300i, BPS 300i Interface: RS 232 Number of connections: 3 Piece(s) Connection: Terminal
	50116468 *	MS 300	Connection unit	Suitable for: BCL 300i, BPS 300i Interface: RS 232 Number of connections: 3 Piece(s) Connection: Connector, M12

\* Necessary accessories, please order separately

## Accessories

### Mounting technology - Mounting brackets

	Part no.	Designation	Article	Description
	50121433	BT 300 W	Mounting device	Design of mounting device: Angle, L-shape Fastening, at system: Through-hole mounting Mounting bracket, at device: Screw type Type of mounting device: Adjustable Material: Metal

### Mounting technology - Rod mounts

	Part no.	Designation	Article	Description
	50121435	BT 56 - 1	Mounting device	Functions: Static applications Design of mounting device: Mounting system Fastening, at system: For 12 mm rod, For 14 mm rod, For 16 mm rod Mounting bracket, at device: Clampable Material: Metal Tightening torque of the clamping jaws: 8 N·m

### Mounting technology - Other

	Part no.	Designation	Article	Description
	50124941	BTU 0300M-W	Mounting device	Fastening, at system: Through-hole mounting Mounting bracket, at device: Clampable, Groove mounting, Suited for M4 screws Material: Metal Shock absorber: No

### Reflective tapes for standard applications

	Part no.	Designation	Article	Description
	50106119	REF 4-A-100x100	Reflective tape	Design: Rectangular Reflective surface: 100 mm x 100 mm Material: Plastic Chemical designation of the material: PMMA Fastening: Self-adhesive

## Services

	Part no.	Designation	Article	Description
	S981020	CS30-E-212	Hourly rate	Details: Compilation of the application data, selection and suggestion of suitable sensor system, drawing prepared as assembly sketch. Conditions: Completed questionnaire or project specifications with a description of the application have been provided. Restrictions: Travel and accommodation charged separately and according to expenditure.



## Accessories

	Part no.	Designation	Article	Description
	S981014	CS30-S-110	Start-up support	<p>Details: Performed at location of customer's choosing, duration: max. 10 hours.</p> <p>Conditions: Devices and connection cables are already mounted, price not including travel costs and, if applicable, accommodation expenses.</p> <p>Restrictions: No mechanical (mounting) and electrical (wiring) work performed, no changes (attachments, wiring, programming) to third-party components in the nearby environment.</p>
	S981019	CS30-T-110	Product training	<p>Details: Location and content to be agreed upon, duration: max. 10 hours.</p> <p>Conditions: Price not including travel costs and, if applicable, accommodation expenses.</p> <p>Restrictions: Travel costs and accommodation expenses charged separately and according to expenditure.</p>
	S981021	CS30-V-212	Hourly rate	<p>Details: REA evaluation with creation of a test report, evaluation of the code quality.</p> <p>Conditions: Original bar codes to be provided by the client.</p>

### Note



A list with all available accessories can be found on the Leuze website in the Download tab of the article detailed page.