

## Technical data sheet Stationary bar code reader

Part no.: 50116404

BCL 308i SM 100 D

### Contents

- Technical data
- Dimensioned drawings
- Electrical connection
- Diagrams
- Operation and display
- Part number code
- Notes
- Accessories



Figure can vary



Ethernet



## Technical data

### Basic data

|        |          |
|--------|----------|
| Series | BCL 300i |
|--------|----------|

### Functions

|           |                           |
|-----------|---------------------------|
| Functions | Alignment mode            |
|           | AutoConfig                |
|           | AutoControl               |
|           | AutoReflAct               |
|           | Code fragment technology  |
|           | LED indicator             |
|           | Reference code comparison |

### Characteristic parameters

|      |           |
|------|-----------|
| MTTF | 110 years |
|------|-----------|

### Read data

|   |                             |
|---|-----------------------------|
| Code types, readable                    | 2/5 Interleaved             |
|   | Codabar                     |
|   | Code 128                    |
|   | Code 39                     |
|   | Code 93                     |
|   | EAN 8/13                    |
|   | GS1 Databar Expanded        |
|   | GS1 Databar Limited         |
|   | GS1 Databar Omnidirectional |
|   | UPC                         |
| Scanning rate, typical                  | 1,000 scans/s               |
| Bar codes per reading gate, max. number | 64 Piece(s)                 |

### Optical data

|  |   |
|--|---|
| Reading distance                             | 30 ... 290 mm   |
| Light source                                 | Laser, Red  |
| Wavelength                                   | 655 nm  |
| Laser class                                  | 1, IEC/EN 60825-1:2014  |
| Transmitted-signal shape                     | Continuous  |
| Usable opening angle (reading field opening) | 60 °  |
| Modulus size                                 | 0.2 ... 0.5 mm  |
| Reading method                               | Line scanner with deflecting mirror                           |
| Beam deflection                              | By means of rotating polygon mirror wheel + deflecting mirror |
| Light beam exit                              | Lateral with deflecting mirror                                |

### Electrical data

|                                     |                              |
|-------------------------------------|------------------------------|
| Protective circuit                  | Polarity reversal protection |
| <b>Performance data</b>             |                              |
| Supply voltage $U_B$                | 18 ... 30 V, DC              |
| Power consumption, max.             | 4.5 W                        |
| <b>Inputs/outputs selectable</b>    |                              |
| Output current, max.                | 60 mA                        |
| Number of inputs/outputs selectable | 2 Piece(s)                   |
| Input current, max.                 | 8 mA                         |

### Interface

|      |          |
|------|----------|
| Type | Ethernet |
|------|----------|

### Ethernet

|                       |                           |
|-----------------------|---------------------------|
| Architecture          | Client                    |
|                       | Server                    |
| Address assignment    | DHCP                      |
|                       | Manual address assignment |
| Transmission speed    | 10 Mbit/s                 |
|                       | 100 Mbit/s                |
| Function              | Process                   |
| Switch functionality  | Integrated                |
| Transmission protocol | TCP/IP, UDP               |

### Service interface

|      |         |
|------|---------|
| Type | USB 2.0 |
|------|---------|

### USB

|          |                            |
|----------|----------------------------|
| Function | Configuration via software |
|          | Service                    |

### Connection

|                       |            |
|-----------------------|------------|
| Number of connections | 1 Piece(s) |
|-----------------------|------------|

### Connection 1

|          |                      |
|----------|----------------------|
| Function | BUS IN               |
|          | BUS OUT              |
|          | Connection to device |
|          | Data interface       |
|          | PWR / SW IN / OUT    |
|          | Service interface    |

**Type of connection** Plug connector. It is essential to use a connection unit when commissioning the device.

|             |         |
|-------------|---------|
| No. of pins | 32 -pin |
| Type        | Male    |

### Mechanical data

|                       |                              |
|-----------------------|------------------------------|
| Design                | Cubic                        |
| Dimension (W x H x L) | 103 mm x 44 mm x 96 mm       |
| Housing material      | Metal                        |
| Metal housing         | Diecast aluminum             |
| Lens cover material   | Glass                        |
| Net weight            | 350 g                        |
| Housing color         | Red                          |
|                       | Silver                       |
| Type of fastening     | Dovetail grooves             |
|                       | Fastening on back            |
|                       | Via optional mounting device |

### Operation and display

|                       |  |
|-----------------------|--|
| Type of display       | LED  |
|                       | Monochromatic graphic display, 128 x 32 pixels |
| Number of LEDs        | 2 Piece(s)                                     |
| Type of configuration | Via web browser                                |

### Environmental data

|                                    |               |
|------------------------------------|---------------|
| Ambient temperature, operation     | 0 ... 40 °C   |
| Ambient temperature, storage       | -20 ... 70 °C |
| Relative humidity (non-condensing) | 0 ... 90 %    |

## Technical data

### Certifications

|   |                                      |
|---|--------------------------------------|
| Degree of protection  | IP 65                                |
| Protection class  | III                                  |
| Certifications  | c UL US                              |
| Test procedure for EMC in accordance with standard              | EN 55022<br>EN 61000-4-2, -3, -4, -6 |
| Test procedure for shock in accordance with standard            | IEC 60068-2-27, test Ea              |
| Test procedure for continuous shock in accordance with standard | IEC 60068-2-29, test Eb              |
| Test procedure for vibration in accordance with standard        | IEC 60068-2-6, test Fc               |

### Classification

|                       |          |
|-----------------------|----------|
| Customs tariff number | 84719000 |
| ECLASS 5.1.4          | 27280102 |
| ECLASS 8.0            | 27280102 |
| ECLASS 9.0            | 27280102 |
| ECLASS 10.0           | 27280102 |
| ECLASS 11.0           | 27280102 |
| ECLASS 12.0           | 27280102 |
| ECLASS 13.0           | 27280102 |
| ETIM 5.0              | EC002550 |
| ETIM 6.0              | EC002550 |
| ETIM 7.0              | EC002550 |
| ETIM 8.0              | EC002550 |

# Dimensioned drawings

All dimensions in millimeters

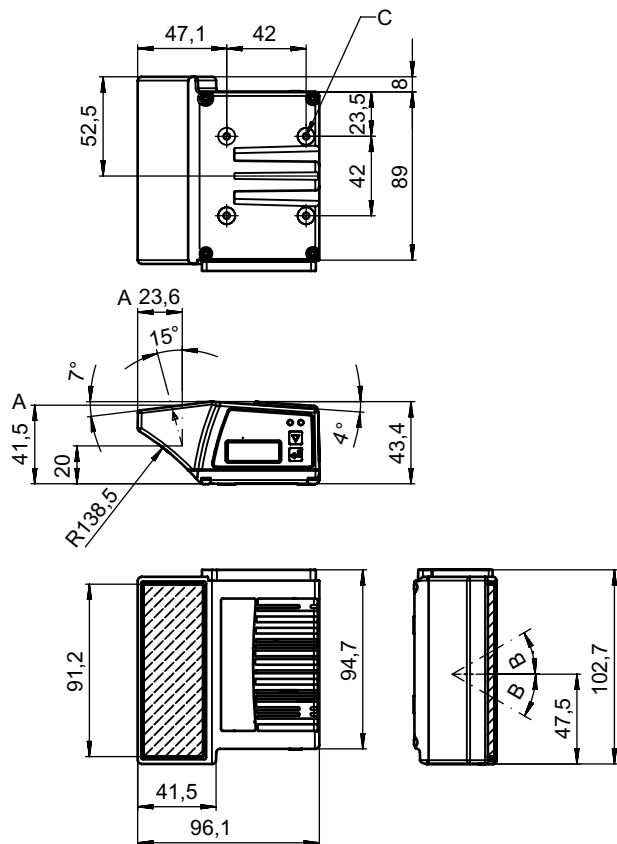

- A Optical axis
- B Deflection angle of the laser beam:  $\pm 30^\circ$
- C M4 thread (5 mm deep)

## Electrical connection

### Connection 1

|                    |   |
|--------------------|---|
| Function           | BUS IN<br>BUS OUT<br>Connection to device<br>Data interface<br>PWR / SW IN / OUT<br>Service interface |
| Type of connection | Plug connector  |
| Type of connection | It is essential to use a connection unit when commissioning the device.                               |
| No. of pins        | 32 -pin   |
| Type               | Male  |

# Diagrams

## Reading field curve

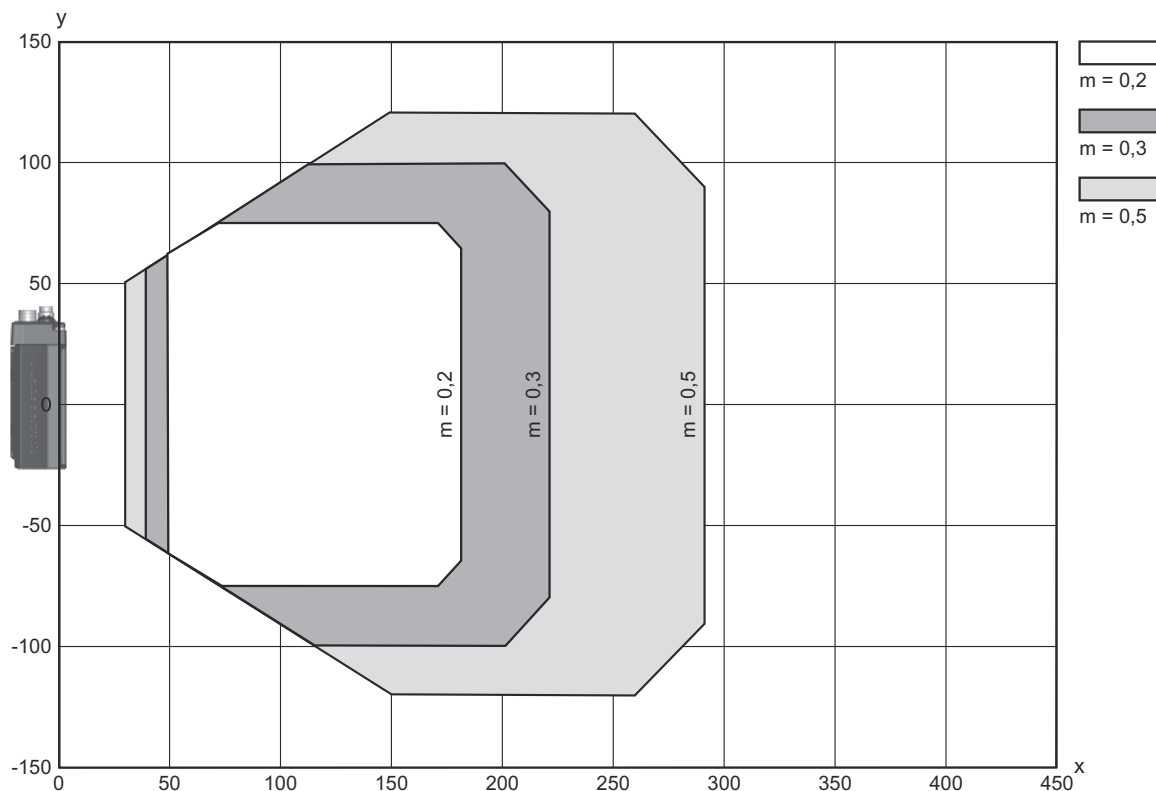

x Reading field distance [mm]  
 y Reading field width [mm]

## Operation and display

| LED   | Display                               | Meaning                         |
|-------|---------------------------------------|---------------------------------|
| 1 PWR | Green, flashing                       | Device ok, initialization phase |
|       | Green, continuous light               | Device OK                       |
|       | Green, briefly off - on               | Reading successful              |
|       | Green, briefly off - briefly red - on | Reading not successful          |
|       | Orange, continuous light              | Service mode                    |
|       | Red, flashing                         | Device OK, warning set          |
|       | Red, continuous light                 | Error, device error             |
| 2 BUS | Green, flashing                       | Initialization                  |
|       | Green, continuous light               | Bus operation ok                |
|       | Red, flashing                         | Communication error             |
|       | Red, continuous light                 | Bus error                       |

# Part number code

Part designation: **BCL XXXX YYZ AAA BB CCCC**

|             |   |
|-------------|---|
| <b>BCL</b>  | <b>Operating principle</b><br>BCL: bar code reader  |
| <b>XXXX</b> | <b>Series/interface (integrated fieldbus technology)</b><br>300i: RS 232 / RS 422 (stand-alone)<br>301i: RS 485 (multiNet slave)<br>304i: PROFIBUS DP<br>308i: EtherNet TCP/IP, UDP<br>338i: EtherCAT<br>348i: PROFINET RT<br>358i: EtherNet/IP |
| <b>YY</b>   | <b>Scanning principle</b><br>S: line scanner (single line)<br>R1: line scanner (raster)<br>O: oscillating-mirror scanner (oscillating mirror)   |
| <b>Z</b>    | <b>Optics</b><br>N: High Density (close)<br>M: Medium Density (medium distance)<br>F: Low Density (remote)<br>L: Long Range (very large distances)<br>J: ink-jet (depending on the application)   |
| <b>AAA</b>  | <b>Beam exit</b><br>100: lateral<br>102: front  |
| <b>BB</b>   | <b>Special equipment</b><br>D: With display<br>H: With heating<br>DH: optionally with display and heating<br>P: plastic exit window   |
| <b>CCCC</b> | <b>Functions</b><br>F007: optimized process data structure<br>F099: OPC-UA function   |

**Note**



↪ A list with all available device types can be found on the Leuze website at [www.leuze.com](http://www.leuze.com).

## Notes

 **Observe intended use!**



- ↪ This product is not a safety sensor and is not intended as personnel protection.
- ↪ The product may only be put into operation by competent persons.
- ↪ Only use the product in accordance with its intended use.

 **ATTENTION! LASER RADIATION – CLASS 1 LASER PRODUCT**









The device satisfies the requirements of IEC/EN 60825-1:2014 safety regulations for a product of **laser class 1** and complies with 21 CFR 1040.10 except for conformance with IEC 60825-1 Ed. 3., as described in Laser Notice No. 56, dated May 8, 2019.













- ↪ Observe the applicable statutory and local laser protection regulations.
- ↪ The device must not be tampered with and must not be changed in any way.  
There are no user-serviceable parts inside the device.  
Repairs must only be performed by Leuze electronic GmbH + Co. KG.

## Accessories



### Connection technology - Connection cables

|   | Part no. | Designation         | Article          | Description  |
|---|----------|---------------------|------------------|--|
|    | 50132079 | KD U-M12-5A-V1-050  | Connection cable | Connection 1: Connector, M12, Axial, Female, A-coded, 5 -pin<br>Connector, LED: No<br>Connection 2: Open end<br>Shielded: No<br>Cable length: 5.000 mm<br>Sheathing material: PVC                                    |
|    | 50135074 | KS ET-M12-4A-P7-050 | Connection cable | Suitable for interface: Ethernet<br>Connection 1: Connector, M12, Axial, Male, D-coded, 4 -pin<br>Connector, LED: No<br>Connection 2: Open end<br>Shielded: Yes<br>Cable length: 5.000 mm<br>Sheathing material: PUR |



### Connection technology - Interconnection cables

|   | Part no. | Designation                 | Article               | Description  |
|---|----------|-----------------------------|-----------------------|--|
|             | 50117011 | KB USB A - USB miniB        | Service line          | Suitable for interface: USB<br>Connection 1: USB<br>Connection 2: USB<br>Shielded: Yes<br>Cable length: 1,500 mm<br>Sheathing material: PVC  |
|     | 50137078 | KSS ET-M12-4A-M12-4A-P7-050 | Interconnection cable | Suitable for interface: Ethernet<br>Connection 1: Connector, M12, Axial, Male, D-coded, 4 -pin<br>Connection 2: Connector, M12, Axial, Male, D-coded, 4 -pin<br>Shielded: Yes<br>Cable length: 5,000 mm<br>Sheathing material: PUR |
|       | 50135081 | KSS ET-M12-4A-RJ45-A-P7-050 | Interconnection cable | Suitable for interface: Ethernet<br>Connection 1: Connector, M12, Axial, Male, D-coded, 4 -pin<br>Connection 2: RJ45<br>Shielded: Yes<br>Cable length: 5,000 mm<br>Sheathing material: PUR   |

### Connection technology - Connection boxes

|  | Part no.   | Designation | Article         | Description   |
|--|------------|-------------|-----------------|---|
|  | 50131255 * | ME 308 103  | Connection unit | Suitable for: BCL 308i<br>Interface: Ethernet<br>Number of connections: 4 Piece(s)<br>Connection: Cable with connector, M12, 900 mm |
|  | 50131254 * | ME 308 104  | Connection unit | Suitable for: BCL 308i<br>Interface: Ethernet<br>Number of connections: 5 Piece(s)<br>Connection: Cable with connector, M12, 900 mm |

## Accessories

|  | Part no.   | Designation | Article         | Description  |
|--|------------|-------------|-----------------|--|
|  | 50116466 * | MK 308      | Connection unit | Suitable for: BCL 308i<br>Interface: Ethernet<br>Number of connections: 4 Piece(s)<br>Connection: Terminal       |
|  | 50114823 * | MS 308      | Connection unit | Suitable for: BCL 308i<br>Interface: Ethernet<br>Number of connections: 4 Piece(s)<br>Connection: Connector, M12 |

\* Necessary accessories, please order separately

## Mounting technology - Mounting brackets

|   | Part no. | Designation | Article         | Description   |
|---|----------|-------------|-----------------|---|
|  | 50121433 | BT 300 W    | Mounting device | Design of mounting device: Angle, L-shape<br>Fastening, at system: Through-hole mounting<br>Mounting bracket, at device: Screw type<br>Type of mounting device: Adjustable<br>Material: Metal |

## Mounting technology - Rod mounts

|  | Part no. | Designation | Article         | Description   |
|--|----------|-------------|-----------------|---|
|  | 50121435 | BT 56 - 1   | Mounting device | Functions: Static applications<br>Design of mounting device: Mounting system<br>Fastening, at system: For 12 mm rod, For 14 mm rod, For 16 mm rod<br>Mounting bracket, at device: Clampable<br>Material: Metal<br>Tightening torque of the clamping jaws: 8 N·m |

## Mounting technology - Other

|   | Part no. | Designation | Article         | Description   |
|---|----------|-------------|-----------------|---|
|  | 50124941 | BTU 0300M-W | Mounting device | Fastening, at system: Through-hole mounting<br>Mounting bracket, at device: Clampable, Groove mounting, Suited for M4 screws<br>Material: Metal<br>Shock absorber: No |



## Reflective tapes for standard applications

|   | Part no. | Designation     | Article         | Description   |
|---|----------|-----------------|-----------------|---|
|  | 50106119 | REF 4-A-100x100 | Reflective tape | Design: Rectangular<br>Reflective surface: 100 mm x 100 mm<br>Material: Plastic<br>Chemical designation of the material: PMMA<br>Fastening: Self-adhesive |

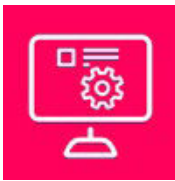

## Accessories

## Services

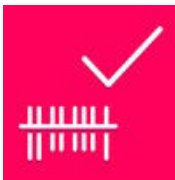
|   | Part no. | Designation | Article          | Description  |
|---|----------|-------------|------------------|--|
|   | S981020  | CS30-E-212  | Hourly rate      | <p>Details: Compilation of the application data, selection and suggestion of suitable sensor system, drawing prepared as assembly sketch.</p> <p>Conditions: Completed questionnaire or project specifications with a description of the application have been provided.</p> <p>Restrictions: Travel and accommodation charged separately and according to expenditure.</p>  |
|   | S981014  | CS30-S-110  | Start-up support | <p>Details: Performed at location of customer's choosing, duration: max. 10 hours.</p> <p>Conditions: Devices and connection cables are already mounted, price not including travel costs and, if applicable, accommodation expenses.</p> <p>Restrictions: No mechanical (mounting) and electrical (wiring) work performed, no changes (attachments, wiring, programming) to third-party components in the nearby environment.</p> |
|   | S981019  | CS30-T-110  | Product training | <p>Details: Location and content to be agreed upon, duration: max. 10 hours.</p> <p>Conditions: Price not including travel costs and, if applicable, accommodation expenses.</p> <p>Restrictions: Travel costs and accommodation expenses charged separately and according to expenditure.</p>   |
|  | S981021  | CS30-V-212  | Hourly rate      | <p>Details: REA evaluation with creation of a test report, evaluation of the code quality.</p> <p>Conditions: Original bar codes to be provided by the client.</p>   |

### Note



A list with all available accessories can be found on the Leuze website in the Download tab of the article detailed page.