

Technical data sheet

Stationary bar code reader

Part no.: 50141848

BCL 338i S N 100 D H F007

Contents

- Technical data
- Dimensioned drawings
- Electrical connection
- Diagrams
- Operation and display
- Part number code
- Notes
- Accessories



Figure can vary



EtherCAT



Technical data

Basic data

| | |
|--------|----------|
| Series | BCL 300i |
|--------|----------|

Special version

| | |
|-----------------|---------|
| Special version | Heating |
|-----------------|---------|

Functions

| | |
|-----------|---------------------------|
| Functions | Alignment mode |
| | AutoConfig |
| | AutoControl |
| | AutoReflAct |
| | Code fragment technology |
| | Heating |
| | LED indicator |
| | Reference code comparison |

Characteristic parameters

| | |
|------|-----------|
| MTTF | 110 years |
|------|-----------|

Read data

| | |
|----------------------|-----------------------------|
| Code types, readable | 2/5 Interleaved |
| | Codabar |
| | Code 128 |
| | Code 39 |
| | Code 93 |
| | EAN 8/13 |
| | GS1 Databar Expanded |
| | GS1 Databar Limited |
| | GS1 Databar Omnidirectional |
| | UPC |

| | |
|------------------------|---------------|
| Scanning rate, typical | 1,000 scans/s |
|------------------------|---------------|

| | |
|---|-------------|
| Bar codes per reading gate, max. number | 64 Piece(s) |
|---|-------------|

Optical data

| | |
|------------------|---------------|
| Reading distance | 20 ... 130 mm |
|------------------|---------------|

| | |
|--------------|------------|
| Light source | Laser, Red |
|--------------|------------|

| | |
|------------|--------|
| Wavelength | 655 nm |
|------------|--------|

| | |
|-------------|------------------------|
| Laser class | 1, IEC/EN 60825-1:2014 |
|-------------|------------------------|

| | |
|--------------------------|------------|
| Transmitted-signal shape | Continuous |
|--------------------------|------------|

| | |
|--|------|
| Usable opening angle (reading field opening) | 60 ° |
|--|------|

| | |
|--------------|------------------|
| Modulus size | 0.127 ... 0.2 mm |
|--------------|------------------|

| | |
|----------------|-------------------------------------|
| Reading method | Line scanner with deflecting mirror |
|----------------|-------------------------------------|

| | |
|-----------------|---|
| Beam deflection | By means of rotating polygon mirror wheel + deflecting mirror |
|-----------------|---|

| | |
|-----------------|--------------------------------|
| Light beam exit | Lateral with deflecting mirror |
|-----------------|--------------------------------|

Electrical data

| | |
|--------------------|------------------------------|
| Protective circuit | Polarity reversal protection |
|--------------------|------------------------------|

Performance data

| | |
|----------------------|-----------------|
| Supply voltage U_B | 18 ... 30 V, DC |
|----------------------|-----------------|

| | |
|-------------------------|------|
| Power consumption, max. | 27 W |
|-------------------------|------|

Inputs/outputs selectable

| | |
|----------------------|-------|
| Output current, max. | 60 mA |
|----------------------|-------|

| | |
|-------------------------------------|------------|
| Number of inputs/outputs selectable | 2 Piece(s) |
|-------------------------------------|------------|

| | |
|---------------------|------|
| Input current, max. | 8 mA |
|---------------------|------|

Interface

| | |
|------|----------|
| Type | EtherCAT |
|------|----------|

EtherCAT

| | |
|----------|---------|
| Function | Process |
|----------|---------|

| | |
|-----------------------|-----------------------|
| Transmission protocol | EtherCAT, CoE and EoE |
|-----------------------|-----------------------|

Service interface

| | |
|------|---------|
| Type | USB 2.0 |
|------|---------|

USB

| | |
|----------|----------------------------|
| Function | Configuration via software |
|----------|----------------------------|

| | |
|--|---------|
| | Service |
|--|---------|

Connection

| | |
|-----------------------|------------|
| Number of connections | 1 Piece(s) |
|-----------------------|------------|

Connection 1

| | |
|----------|--------|
| Function | BUS IN |
|----------|--------|

| | |
|--|---------|
| | BUS OUT |
|--|---------|

| | |
|--|----------------------|
| | Connection to device |
|--|----------------------|

| | |
|--|----------------|
| | Data interface |
|--|----------------|

| | |
|--|-------------------|
| | PWR / SW IN / OUT |
|--|-------------------|

| | |
|--|-------------------|
| | Service interface |
|--|-------------------|

| | |
|--------------------|---|
| Type of connection | Plug connector, It is essential to use a connection unit when commissioning the device. |
|--------------------|---|

| | |
|-------------|---------|
| No. of pins | 32 -pin |
|-------------|---------|

| | |
|------|------|
| Type | Male |
|------|------|

Mechanical data

| | |
|--------|-------|
| Design | Cubic |
|--------|-------|

| | |
|-----------------------|------------------------|
| Dimension (W x H x L) | 103 mm x 44 mm x 96 mm |
|-----------------------|------------------------|

| | |
|------------------|-------|
| Housing material | Metal |
|------------------|-------|

| | |
|---------------|------------------|
| Metal housing | Diecast aluminum |
|---------------|------------------|

| | |
|---------------------|-------|
| Lens cover material | Glass |
|---------------------|-------|

| | |
|------------|-------|
| Net weight | 370 g |
|------------|-------|

| | |
|---------------|-----|
| Housing color | Red |
|---------------|-----|

| | |
|--|--------|
| | Silver |
|--|--------|

| | |
|-------------------|------------------|
| Type of fastening | Dovetail grooves |
|-------------------|------------------|

| | |
|--|-------------------|
| | Fastening on back |
|--|-------------------|

| | |
|--|------------------------------|
| | Via optional mounting device |
|--|------------------------------|

Operation and display

| | |
|-----------------|-----|
| Type of display | LED |
|-----------------|-----|

| | |
|--|--|
| | Monochromatic graphic display, 128 x 32 pixels |
|--|--|

| | |
|----------------|------------|
| Number of LEDs | 2 Piece(s) |
|----------------|------------|

| | |
|-----------------------|-----------------|
| Type of configuration | Via web browser |
|-----------------------|-----------------|

| | |
|----------------------|-----------|
| Operational controls | Button(s) |
|----------------------|-----------|

Environmental data

| | |
|--------------------------------|---------------|
| Ambient temperature, operation | -35 ... 40 °C |
|--------------------------------|---------------|

| | |
|------------------------------|---------------|
| Ambient temperature, storage | -20 ... 70 °C |
|------------------------------|---------------|

| | |
|------------------------------------|------------|
| Relative humidity (non-condensing) | 0 ... 90 % |
|------------------------------------|------------|

Technical data

Certifications

| | |
|---|--------------------------------------|
| Degree of protection | IP 65 |
| Protection class | III |
| Certifications | c UL US |
| Test procedure for EMC in accordance with standard | EN 55022 EN 61000-4-2, -3, -4, -6 |
| Test procedure for shock in accordance with standard | IEC 60068-2-27, test Ea |
| Test procedure for continuous shock in accordance with standard | IEC 60068-2-29, test Eb |
| Test procedure for vibration in accordance with standard | IEC 60068-2-6, test Fc |

Classification

| | |
|-----------------------|----------|
| Customs tariff number | 84719000 |
| ECLASS 5.1.4 | 27280102 |
| ECLASS 8.0 | 27280102 |
| ECLASS 9.0 | 27280102 |
| ECLASS 10.0 | 27280102 |
| ECLASS 11.0 | 27280102 |
| ECLASS 12.0 | 27280102 |
| ECLASS 13.0 | 27280102 |
| ETIM 5.0 | EC002550 |
| ETIM 6.0 | EC002550 |
| ETIM 7.0 | EC002550 |
| ETIM 8.0 | EC002550 |

Dimensioned drawings

All dimensions in millimeters

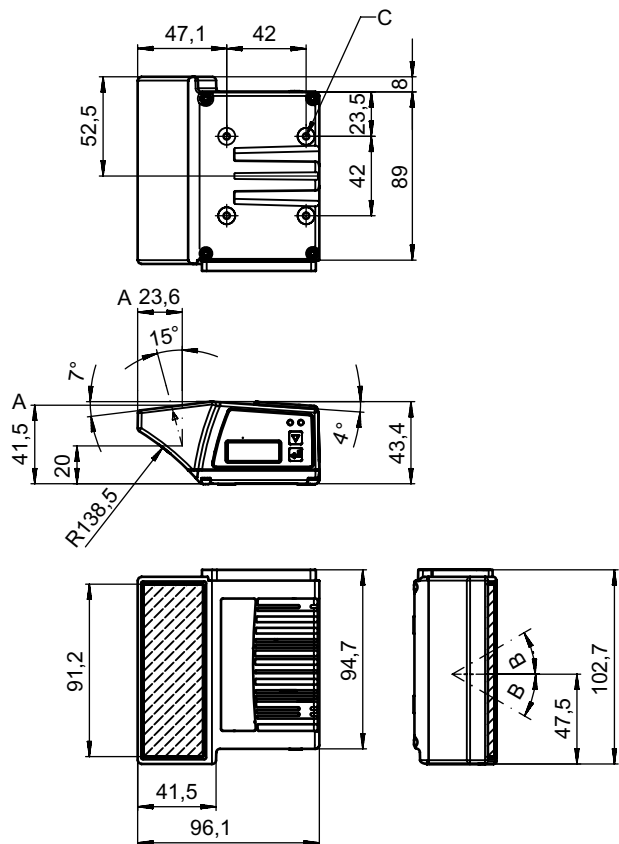

- A Optical axis
- B Deflection angle of the laser beam: $\pm 30^\circ$
- C M4 thread (5 mm deep)

Electrical connection

Connection 1

| | |
|---------------------------|---|
| Function | BUS IN BUS OUT Connection to device Data interface PWR / SW IN / OUT Service interface |
| Type of connection | Plug connector |
| Type of connection | It is essential to use a connection unit when commissioning the device. |
| No. of pins | 32 -pin |
| Type | Male |

Diagrams

Reading field curve

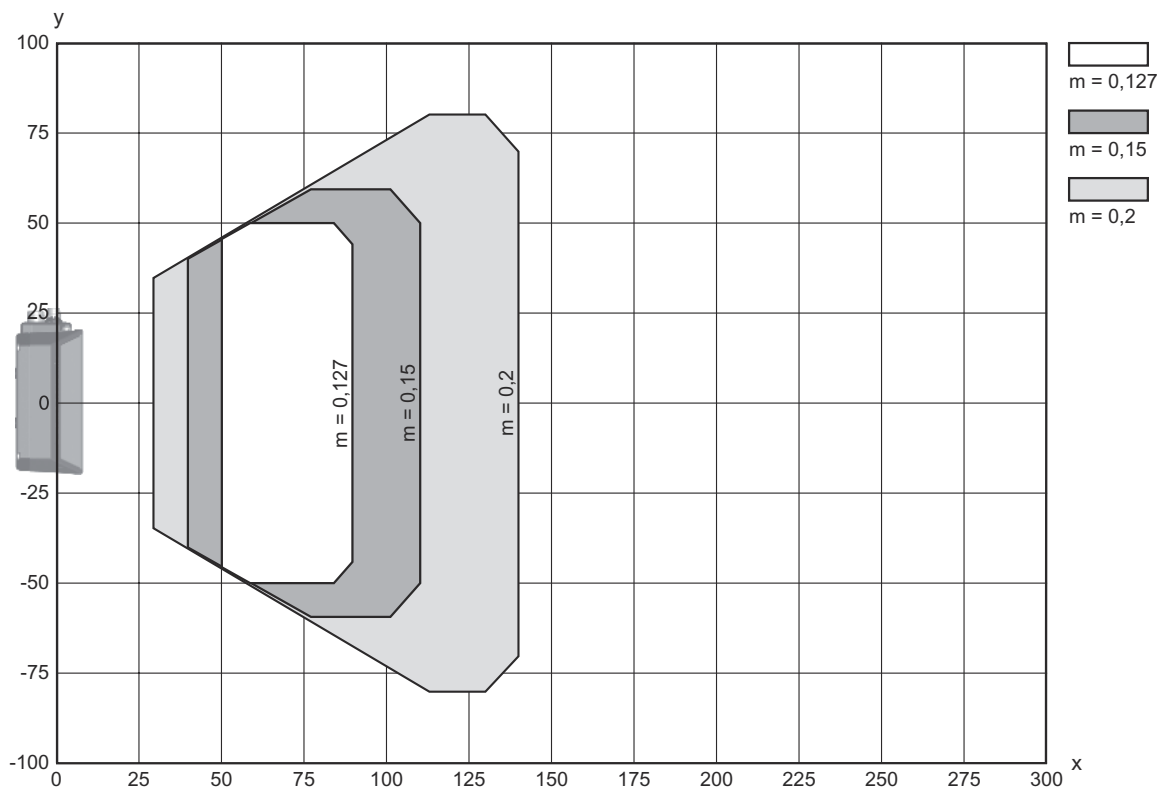

x Reading field distance [mm]
 y Reading field width [mm]

Operation and display

| LED | Display | Meaning |
|-------|---------------------------------------|---------------------------------|
| 1 PWR | Green, flashing | Device ok, initialization phase |
| | Green, continuous light | Device OK |
| | Green, briefly off - on | Reading successful |
| | Green, briefly off - briefly red - on | Reading not successful |
| | Orange, continuous light | Service mode |
| | Red, flashing | Device OK, warning set |
| | Red, continuous light | Error, device error |
| 2 BUS | Green, flashing | Initialization |
| | Green, continuous light | Bus operation ok |
| | Red, flashing | Communication error |
| | Red, continuous light | Bus error |

Part number code

Part designation: **BCL XXXX YYZ AAA BB CCCC**

| | |
|-------------|---|
| BCL | Operating principle BCL: bar code reader |
| XXXX | Series/interface (integrated fieldbus technology) 300i: RS 232 / RS 422 (stand-alone) 301i: RS 485 (multiNet slave) 304i: PROFIBUS DP 308i: EtherNet TCP/IP, UDP 338i: EtherCAT 348i: PROFINET RT 358i: EtherNet/IP |
| YY | Scanning principle S: line scanner (single line) R1: line scanner (raster) O: oscillating-mirror scanner (oscillating mirror) |
| Z | Optics N: High Density (close) M: Medium Density (medium distance) F: Low Density (remote) L: Long Range (very large distances) J: ink-jet (depending on the application) |
| AAA | Beam exit 100: lateral 102: front |
| BB | Special equipment D: With display H: With heating DH: optionally with display and heating P: plastic exit window |
| CCCC | Functions F007: optimized process data structure F099: OPC-UA function |

Note



↪ A list with all available device types can be found on the Leuze website at www.leuze.com.

Notes

 **Observe intended use!**



- ↪ This product is not a safety sensor and is not intended as personnel protection.
- ↪ The product may only be put into operation by competent persons.
- ↪ Only use the product in accordance with its intended use.

 **ATTENTION! LASER RADIATION – CLASS 1 LASER PRODUCT**







The device satisfies the requirements of IEC/EN 60825-1:2014 safety regulations for a product of **laser class 1** and complies with 21 CFR 1040.10 except for conformance with IEC 60825-1 Ed. 3., as described in Laser Notice No. 56, dated May 8, 2019.







- ↪ Observe the applicable statutory and local laser protection regulations.
- ↪ The device must not be tampered with and must not be changed in any way.
There are no user-serviceable parts inside the device.
Repairs must only be performed by Leuze electronic GmbH + Co. KG.

Accessories

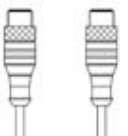

Connection technology - Connection cables

| | Part no. | Designation | Article | Description |
|---|----------|---------------------|------------------|--|
|  | 50132079 | KD U-M12-5A-V1-050 | Connection cable | Connection 1: Connector, M12, Axial, Female, A-coded, 5 -pin Connector, LED: No Connection 2: Open end Shielded: No Cable length: 5.000 mm Sheathing material: PVC |
|  | | | | |
|  | 50135074 | KS ET-M12-4A-P7-050 | Connection cable | Suitable for interface: Ethernet Connection 1: Connector, M12, Axial, Male, D-coded, 4 -pin Connector, LED: No Connection 2: Open end Shielded: Yes Cable length: 5.000 mm Sheathing material: PUR |
|  | | | | |



Connection technology - Interconnection cables

| | Part no. | Designation | Article | Description |
|---|----------|-----------------------------|-----------------------|--|
|  | 50117011 | KB USB A - USB miniB | Service line | Suitable for interface: USB Connection 1: USB Connection 2: USB Shielded: Yes Cable length: 1,500 mm Sheathing material: PVC |
|  | | | | |
|  | 50137078 | KSS ET-M12-4A-M12-4A-P7-050 | Interconnection cable | Suitable for interface: Ethernet Connection 1: Connector, M12, Axial, Male, D-coded, 4 -pin Connection 2: Connector, M12, Axial, Male, D-coded, 4 -pin Shielded: Yes Cable length: 5,000 mm Sheathing material: PUR |
|  | | | | |
|  | 50135081 | KSS ET-M12-4A-RJ45-A-P7-050 | Interconnection cable | Suitable for interface: Ethernet Connection 1: Connector, M12, Axial, Male, D-coded, 4 -pin Connection 2: RJ45 Shielded: Yes Cable length: 5,000 mm Sheathing material: PUR |
|  | | | | |
|  | | | | |
|  | | | | |

Connection technology - Connection boxes

| | Part no. | Designation | Article | Description |
|--|------------|-------------|-----------------|---|
|  | 50134929 * | ME 338 103 | Connection unit | Suitable for: BCL 338i, BPS 338i Interface: EtherCAT Number of connections: 4 Piece(s) Connection: Cable with connector, M12, 900 mm |
|  | 50134927 * | ME 338 104 | Connection unit | Suitable for: BCL 338i Interface: EtherCAT Number of connections: 5 Piece(s) Connection: Cable with connector, M12, 900 mm |
|  | 50134928 * | ME 338 214 | Connection unit | Suitable for: BCL 338i Interface: EtherCAT Number of connections: 5 Piece(s) Connection: Cable with connector, M12, 600 mm |

Accessories

| | Part no. | Designation | Article | Description |
|---|------------|-------------|-----------------|--|
|  | 50134931 * | MK 338 | Connection unit | Suitable for: BCL 338i, BPS 338i Interface: EtherCAT Number of connections: 4 Piece(s) Connection: Terminal |
|  | 50134930 * | MS 338 | Connection unit | Suitable for: BCL 338i, BPS 338i Interface: EtherCAT Number of connections: 4 Piece(s) Connection: Connector, M12 |

* Necessary accessories, please order separately

Mounting technology - Mounting brackets

| | Part no. | Designation | Article | Description |
|---|----------|-------------|-----------------|---|
|  | 50121433 | BT 300 W | Mounting device | Design of mounting device: Angle, L-shape Fastening, at system: Through-hole mounting Mounting bracket, at device: Screw type Type of mounting device: Adjustable Material: Metal |

Mounting technology - Rod mounts

| | Part no. | Designation | Article | Description |
|--|----------|-------------|-----------------|---|
|  | 50121435 | BT 56 - 1 | Mounting device | Functions: Static applications Design of mounting device: Mounting system Fastening, at system: For 12 mm rod, For 14 mm rod, For 16 mm rod Mounting bracket, at device: Clampable Material: Metal Tightening torque of the clamping jaws: 8 N·m |

Mounting technology - Other





| | Part no. | Designation | Article | Description |
|---|----------|-------------|-----------------|---|
|  | 50124941 | BTU 0300M-W | Mounting device | Fastening, at system: Through-hole mounting Mounting bracket, at device: Clampable, Groove mounting, Suited for M4 screws Material: Metal Shock absorber: No |

Accessories

Reflective tapes for standard applications

| | Part no. | Designation | Article | Description |
|---|----------|-----------------|-----------------|---|
|  | 50106119 | REF 4-A-100x100 | Reflective tape | Design: Rectangular Reflective surface: 100 mm x 100 mm Material: Plastic Chemical designation of the material: PMMA Fastening: Self-adhesive |

Services

| | Part no. | Designation | Article | Description |
|--|----------|-------------|------------------|---|
|  | S981020 | CS30-E-212 | Hourly rate | Details: Compilation of the application data, selection and suggestion of suitable sensor system, drawing prepared as assembly sketch. Conditions: Completed questionnaire or project specifications with a description of the application have been provided. Restrictions: Travel and accommodation charged separately and according to expenditure. |
|  | S981014 | CS30-S-110 | Start-up support | Details: Performed at location of customer's choosing, duration: max. 10 hours. Conditions: Devices and connection cables are already mounted, price not including travel costs and, if applicable, accommodation expenses. Restrictions: No mechanical (mounting) and electrical (wiring) work performed, no changes (attachments, wiring, programming) to third-party components in the nearby environment. |
|  | S981019 | CS30-T-110 | Product training | Details: Location and content to be agreed upon, duration: max. 10 hours. Conditions: Price not including travel costs and, if applicable, accommodation expenses. Restrictions: Travel costs and accommodation expenses charged separately and according to expenditure. |
|  | S981021 | CS30-V-212 | Hourly rate | Details: REA evaluation with creation of a test report, evaluation of the code quality. Conditions: Original bar codes to be provided by the client. |

Note



A list with all available accessories can be found on the Leuze website in the Download tab of the article detailed page.