

## Technical data sheet

### Optical distance sensor

Part no.: 50113693  
AMS 335i 40

#### Contents

- Technical data
- Dimensioned drawings
- Electrical connection
- Operation and display
- Part number code
- Notes
- Further information
- Accessories



Figure can vary



CDRH

CANopen



## Technical data

### Basic data

|             |  |
|-------------|--|
| Series      | AMS 300i   |
| Application | Collision protection of cranes / gantry cranes<br>Positioning of electroplating plants<br>Positioning of skillet systems and side-tracking skates<br>Positioning of stacker cranes |

### Characteristic parameters

|      |          |
|------|----------|
| MTTF | 31 years |
|------|----------|

### Optical data

|              |                        |
|--------------|------------------------|
| Light source | Laser, Red             |
| Wavelength   | 655 nm                 |
| Laser class  | 2, IEC/EN 60825-1:2014 |

### Measurement data

|                                    |                   |
|------------------------------------|-------------------|
| Measurement value calculation time | 8 ms              |
| Measurement range                  | 200 ... 40,000 mm |
| Accuracy                           | 2 mm              |
| Reproducibility (3 sigma)          | 0.9 mm            |
| Measurement value output           | 1.7 ms            |
| Temperature drift                  | 0.01 ... 0.1 mm/K |
| Max. traverse rate                 | 10 m/s            |

### Electrical data

|                      |                 |
|----------------------|-----------------|
| Performance data     |                 |
| Supply voltage $U_B$ | 18 ... 30 V, DC |

### Interface

|                    |                     |
|--------------------|---------------------|
| Type               | CANopen             |
| CANopen            |                     |
| Transmission speed | 10 ... 1,000 kBit/s |

### Connection

|                       |                           |
|-----------------------|---------------------------|
| Number of connections | 4 Piece(s)                |
| Connection 1          |                           |
| Function              | BUS IN<br>Data interface  |
| Type of connection    | Connector                 |
| Designation on device | BUS IN                    |
| Thread size           | M12                       |
| Type                  | Male                      |
| No. of pins           | 5 -pin                    |
| Encoding              | A-coded                   |
| Connection 2          |                           |
| Function              | BUS OUT<br>Data interface |
| Type of connection    | Connector                 |
| Designation on device | BUS OUT                   |
| Thread size           | M12                       |
| Type                  | Female                    |
| No. of pins           | 5 -pin                    |
| Encoding              | A-coded                   |

### Connection 3

|                       |                                     |
|-----------------------|-------------------------------------|
| Function              | PWR / SW IN / OUT<br>Voltage supply |
| Type of connection    | Connector                           |
| Designation on device | PWR                                 |
| Thread size           | M12                                 |
| Type                  | Male                                |
| No. of pins           | 5 -pin                              |
| Encoding              | A-coded                             |

### Connection 4

|                       |                   |
|-----------------------|-------------------|
| Function              | Service interface |
| Type of connection    | Connector         |
| Designation on device | SERVICE           |
| Thread size           | M12               |
| Type                  | Female            |
| No. of pins           | 5 -pin            |
| Encoding              | A-coded           |

### Mechanical data

|                       |                           |
|-----------------------|---------------------------|
| Design                | Cubic                     |
| Dimension (W x H x L) | 84 mm x 166.5 mm x 159 mm |
| Housing material      | Metal                     |
| Lens cover material   | Glass                     |
| Net weight            | 2,450 g                   |
| Type of fastening     | Through-hole mounting     |

### Operation and display

|                      |                   |
|----------------------|-------------------|
| Type of display      | LC Display<br>LED |
| Operational controls | Membrane keyboard |

### Environmental data

|                                    |               |
|------------------------------------|---------------|
| Ambient temperature, operation     | -5 ... 50 °C  |
| Ambient temperature, storage       | -30 ... 70 °C |
| Relative humidity (non-condensing) | 90 %          |

### Certifications

|                      |         |
|----------------------|---------|
| Degree of protection | IP 65   |
| Protection class     | III     |
| Certifications       | c UL US |

### Classification

|                       |          |
|-----------------------|----------|
| Customs tariff number | 90318020 |
| ECLASS 5.1.4          | 27270801 |
| ECLASS 8.0            | 27270801 |
| ECLASS 9.0            | 27270801 |
| ECLASS 10.0           | 27270801 |
| ECLASS 11.0           | 27270801 |
| ECLASS 12.0           | 27270916 |
| ECLASS 13.0           | 27270916 |
| ETIM 5.0              | EC001825 |
| ETIM 6.0              | EC001825 |
| ETIM 7.0              | EC001825 |
| ETIM 8.0              | EC001825 |

## Dimensioned drawings

All dimensions in millimeters

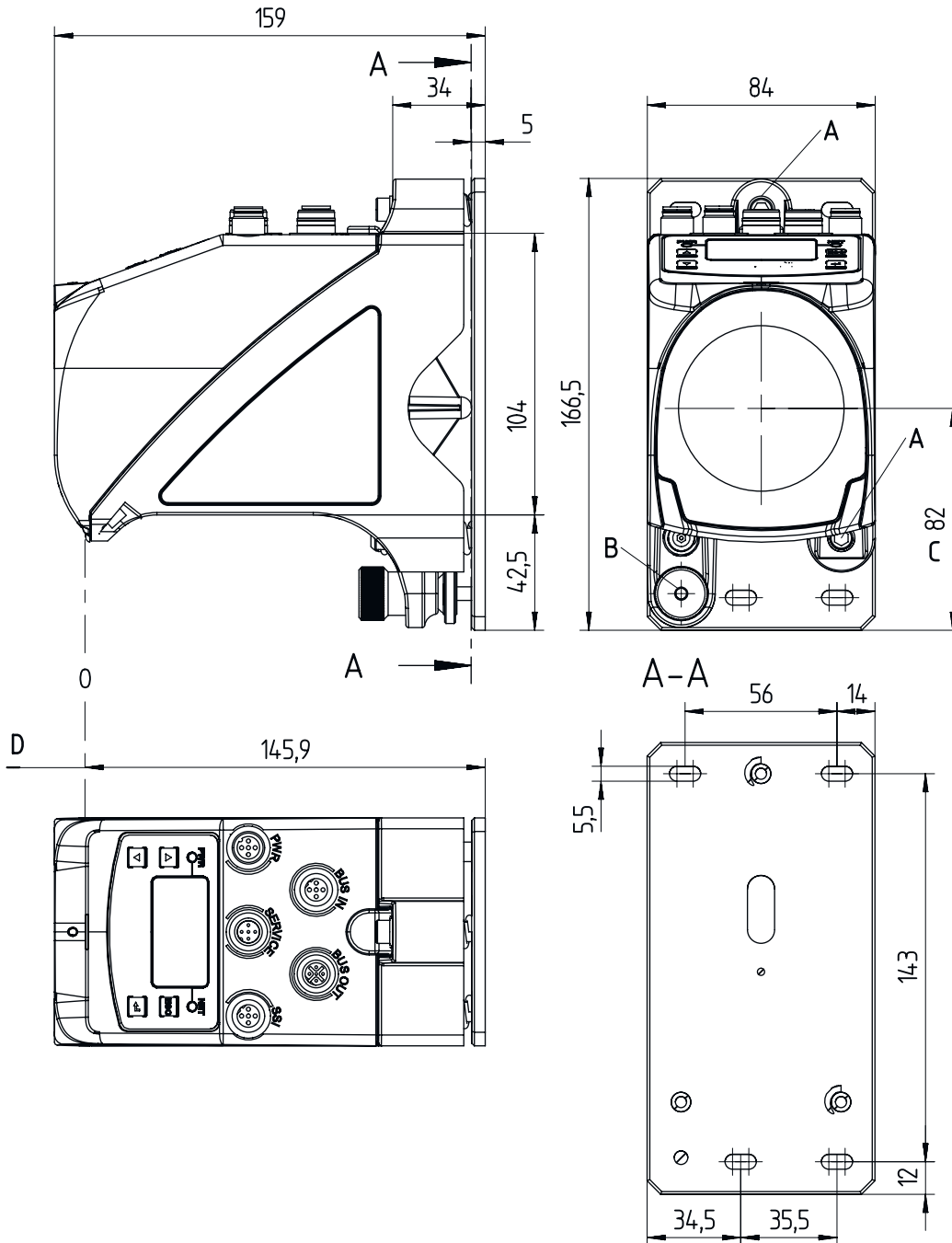

- |   |  |   |   |
|---|--|---|---|
| A | M5 screw for alignment                                       | C | Optical axis                              |
| B | Knurled nut with WAF4 hexagon socket and M5 nut for securing | D | Zero point of the distance to be measured |

## Electrical connection

### Connection 1

### BUS IN

|                    |                          |
|--------------------|--------------------------|
| Function           | BUS IN<br>Data interface |
| Type of connection | Connector                |
| Thread size        | M12                      |
| Type               | Male                     |
| Material           | Metal                    |
| No. of pins        | 5 -pin                   |
| Encoding           | A-coded                  |

| Pin | Pin assignment |
|-----|----------------|
| 1   | Drain          |
| 2   | NC             |
| 3   | NC             |
| 4   | CAN H          |
| 5   | CAN L          |

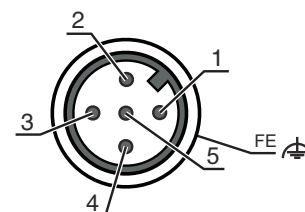

### Connection 2

### BUS OUT

|                    |                           |
|--------------------|---------------------------|
| Function           | BUS OUT<br>Data interface |
| Type of connection | Connector                 |
| Thread size        | M12                       |
| Type               | Female                    |
| Material           | Metal                     |
| No. of pins        | 5 -pin                    |
| Encoding           | A-coded                   |

| Pin | Pin assignment |
|-----|----------------|
| 1   | Drain          |
| 2   | n.c.           |
| 3   | n.c.           |
| 4   | CAN H          |
| 5   | CAN L          |

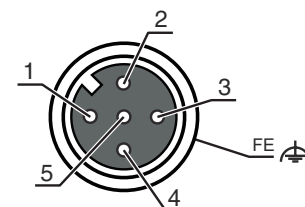

### Connection 3

### PWR

|                    |                                     |
|--------------------|-------------------------------------|
| Function           | PWR / SW IN / OUT<br>Voltage supply |
| Type of connection | Connector                           |
| Thread size        | M12                                 |
| Type               | Male                                |
| Material           | Metal                               |
| No. of pins        | 5 -pin                              |
| Encoding           | A-coded                             |

| Pin | Pin assignment |
|-----|----------------|
| 1   | VIN            |
| 2   | I/O 1          |
| 3   | GND            |
| 4   | I/O 2          |
| 5   | FE             |

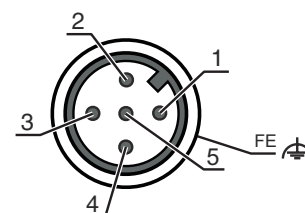

## Electrical connection

### Connection 4

### SERVICE

|                    |                   |
|--------------------|-------------------|
| Function           | Service interface |
| Type of connection | Connector         |
| Thread size        | M12               |
| Type               | Female            |
| Material           | Metal             |
| No. of pins        | 5 -pin            |
| Encoding           | A-coded           |

### Pin Pin assignment

|   |           |
|---|-----------|
| 1 | n.c.      |
| 2 | RS 232-TX |
| 3 | GND       |
| 4 | RS 232-RX |
| 5 | n.c.      |



## Operation and display

| LED   | Display                         | Meaning  |
|-------|---------------------------------|--|
| 1 PWR | Off                             | No supply voltage  |
|       | Green, flashing                 | Voltage connected / no measurement value output / initialization running |
|       | Green, continuous light         | Device OK, measurement value output                                      |
|       | Red, flashing                   | Device OK, warning set   |
|       | Red, continuous light           | No measurement value output  |
|       | Orange, continuous light        | No data transmission   |
| 2 BUS | Off                             | No supply voltage  |
|       | Green, flashing                 | "PRE-OPERATIONAL" and "STOPPED" state                                    |
|       | Green, continuous light         | "OPERATIONAL" state  |
|       | Red, flashing                   | Configuration error  |
|       | Red, continuous light           | Device not on the bus  |
|       | Red/green, flashing alternately | Bus error  |

## Part number code

Part designation: AMS 3XXi YYY Z AAA

|      |  |
|------|--|
| AMS  | <b>Operating principle</b><br>AMS: absolute measurement system   |
| 3XXi | <b>Series/interface (integrated fieldbus technology)</b><br>300i: RS 422/RS 232<br>301i: RS 485<br>304i: PROFIBUS DP / SSI<br>308i: TCP/IP<br>335i: CANopen<br>338i: EtherCAT<br>348i: PROFINET RT<br>355i: DeviceNet<br>358i: EtherNet/IP<br>384i: Interbus |

## Part number code

|     |   |
|-----|---|
| YYY | <b>Operating range</b><br>40: max. operating range in m<br>120: max. operating range in m<br>200: max. operating range in m<br>300: max. operating range in m |
| Z   | <b>Special equipment</b><br>H: With heating   |
| AAA | <b>Interface</b><br>SSI: with SSI interface   |

### Note

|  |   |
|--|---|
|  | <ul style="list-style-type: none"> <li>A list with all available device types can be found on the Leuze website at <a href="http://www.leuze.com">www.leuze.com</a>.</li> </ul> |
|--|---|

## Notes

### Observe intended use!

|  |   |
|--|---|
|  | <ul style="list-style-type: none"> <li>This product is not a safety sensor and is not intended as personnel protection.</li> <li>The product may only be put into operation by competent persons.</li> <li>Only use the product in accordance with its intended use.</li> </ul> |
|--|---|

### ATTENTION! LASER RADIATION – CLASS 2 LASER PRODUCT

|  |   |
|--|---|
|  | <p><b>Do not stare into beam!</b><br/>         The device satisfies the requirements of IEC/EN 60825-1:2014 safety regulations for a product of <b>laser class 2</b> as well as the U.S. 21 CFR 1040.10 regulations with deviations corresponding to Laser Notice No. 56 from May 08, 2019.</p> <ul style="list-style-type: none"> <li>Never look directly into the laser beam or in the direction of reflected laser beams! If you look into the beam path over a longer time period, there is a risk of injury to the retina.</li> <li>Do not point the laser beam of the device at persons!</li> <li>Interrupt the laser beam using a non-transparent, non-reflective object if the laser beam is accidentally directed towards a person.</li> <li>When mounting and aligning the device, avoid reflections of the laser beam off reflective surfaces!</li> <li>CAUTION! Use of controls or adjustments or performance of procedures other than specified herein may result in hazardous light exposure.</li> <li>Observe the applicable statutory and local laser protection regulations.</li> <li>The device must not be tampered with and must not be changed in any way.<br/>           There are no user-serviceable parts inside the device.<br/>           Repairs must only be performed by Leuze electronic GmbH + Co. KG.</li> </ul> |
|--|---|

### NOTE

|  |   |
|--|---|
|  | <p><b>Affix laser information and warning signs!</b><br/>         Laser information and warning signs are affixed to the device. In addition, self-adhesive laser information and warning signs (stick-on labels) are supplied in several languages.</p> <ul style="list-style-type: none"> <li>Affix the laser information sheet to the device in the language appropriate for the place of use. When using the device in the US, use the stick-on label with the "Complies with 21 CFR 1040.10" note.</li> <li>Affix the laser information and warning signs near the device if no signs are attached to the device (e.g. because the device is too small) or if the attached laser information and warning signs are concealed due to the installation position.</li> <li>Affix the laser information and warning signs so that they are legible without exposing the reader to the laser radiation of the device or other optical radiation.</li> </ul> |
|--|---|

## Further information

- For UL applications, use is only permitted in Class 2 circuits in accordance with the NEC (National Electric Code).
- Use as safety-related component within the safety function is possible, if the component combination is designed correspondingly by the machine manufacturer.

## Accessories

### Connection technology - Connection cables

|   | Part no. | Designation        | Article          | Description   |
|---|----------|--------------------|------------------|---|
|  | 50132079 | KD U-M12-5A-V1-050 | Connection cable | Connection 1: Connector, M12, Axial, Female, A-coded, 5 -pin<br>Connector, LED: No<br>Connection 2: Open end<br>Shielded: No<br>Cable length: 5.000 mm<br>Sheathing material: PVC |

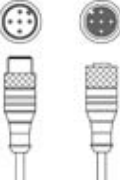

### Connection technology - Interconnection cables

|  | Part no. | Designation        | Article               | Description  |
|--|----------|--------------------|-----------------------|--|
|  | 50114698 | KB DN/CAN-5000 SBA | Interconnection cable | Suitable for interface: DeviceNet, CANopen<br>Connection 1: Connector, M12, Axial, Male, A-coded, 5 -pin<br>Connection 2: Connector, M12, Axial, Female, A-coded, 5 -pin<br>Shielded: Yes<br>Cable length: 5,000 mm<br>Sheathing material: PUR |

### Connection technology - Terminating resistors

|  | Part no. | Designation | Article         | Description   |
|--|----------|-------------|-----------------|---|
|  | 50040099 | TS 01-5-SA  | Terminator plug | Suitable for: DeviceNet, CANopen<br>Function: Bus termination<br>Connection 1: Connector, M12, Axial, Male, A-coded, 5 -pin |

### Reflective tapes for distance sensors

|   | Part no. | Designation                | Article         | Description  |
|---|----------|----------------------------|-----------------|--|
|  | 50115020 | Reflexfolie<br>200x200mm-H | Reflector       | Special version: Heating<br>Supply voltage: 230 V, AC<br>Design: Rectangular<br>Reflective surface: 200 mm x 200 mm<br>Base material: Aluminum composite<br>Fastening: Mounting plate, Through-hole mounting |
|   | 50104361 | Reflexfolie<br>200x200mm-S | Reflective tape | Design: Rectangular<br>Reflective surface: 200 mm x 200 mm<br>Chemical designation of the material: PMMA<br>Fastening: Adhesive  |

## Accessories

### Deflecting mirror

|  | Part no. | Designation | Article           | Description                              |
|--|----------|-------------|-------------------|--|
|  | 50104479 | US AMS 01   | Deflecting mirror | Type of fastening: Through-hole mounting |

### Services

|  | Part no. | Designation | Article          | Description  |
|--|----------|-------------|------------------|--|
|  | S981001  | CS10-S-110  | Start-up support | <p>Details: Performed at location of customer's choosing, duration: max. 10 hours.</p> <p>Conditions: Devices and connection cables are already mounted, price not including travel costs and, if applicable, accommodation expenses.</p> <p>Restrictions: No mechanical (mounting) and electrical (wiring) work performed, no changes (attachments, wiring, programming) to third-party components in the nearby environment.</p> |
|  | S981005  | CS10-T-110  | Product training | <p>Details: Location and content to be agreed upon, duration: max. 10 hours.</p> <p>Conditions: Price not including travel costs and, if applicable, accommodation expenses.</p> <p>Restrictions: Travel costs and accommodation expenses charged separately and according to expenditure.</p>   |

#### Note



A list with all available accessories can be found on the Leuze website in the Download tab of the article detailed page.