

Technical data sheet

Stationary bar code reader

Part no.: 50105418
BCL 8 SN 102



Contents

- Technical data
- Dimensioned drawings
- Electrical connection
- Diagrams
- Operation and display
- Notes
- Accessories



Figure can vary

Technical data

Basic data

Series	BCL 8
--------	-------

Functions

Functions	Alignment mode
	AutoConfig
	AutoRefAct
	Daisy Chain
	I/O
	LED indicator
	Multiple read
	Output format selectable
	Reading gate control
	Reference code comparison

Read data

Code types, readable	2/5 Interleaved
	Codabar
	Code 128
	Code 39
	Code 93
	EAN 128
	EAN 8/13
	EAN Addendum
	Pharma Code
	Pharmacode (available upon consultation)
	UPC
Scanning rate, typical	500 scans/s
Bar codes per reading gate, max. number	63 Piece(s)

Optical data

Reading distance	50 ... 110 mm
Light source	Laser, Red
Wavelength	655 nm
Laser class	1, IEC/EN 60825-1:2014
Transmitted-signal shape	Continuous
Usable opening angle (reading field opening)	60 °
Modulus size	0.12 ... 0.4 mm
Reading method	Line scanner
Scanning rate	500 scans/s
Beam deflection	Via rotating polygon wheel
Light beam exit	Front

Electrical data

Protective circuit	Short circuit protected
Performance data	
Supply voltage U_B	4.75 ... 5.5 V, DC
Current consumption, max.	250 mA

Inputs/outputs selectable

Output current, max.	20 mA
Number of inputs/outputs selectable	1 Piece(s)
Voltage type, outputs	DC
Switching voltage, outputs	Typ. $U_B / 0$ V
Voltage type, inputs	DC
Switching voltage, inputs	Max. 24 V DC
	Typ. $U_B / 0$ V
Input current, max.	20 mA

Input/output 1

Function	Freely configurable
----------	---------------------

Interface

Type	RS 232
------	--------

RS 232

Function	Process
Transmission speed	4,800 ... 57,600 Bd
Data format	Adjustable
Start bit	1
Data bit	7,8
Stop bit	1.2
Parity	Adjustable
Transmission protocol	Adjustable
Data encoding	ASCII
	HEX

Service interface

Type	RS 232
------	--------

RS 232

Function	Service
----------	---------

Connection

Number of connections	1 Piece(s)
-----------------------	------------

Connection 1

Function	Data interface
	PWR / SW IN / OUT
Type of connection	Connector
Thread size	M12
Type	Male
Material	Metal
No. of pins	5 -pin
Encoding	A-coded

Mechanical data

Design	Cubic
Dimension (W x H x L)	40.3 mm x 48 mm x 15 mm
Housing material	Metal
Metal housing	Zinc
Lens cover material	Glass
Net weight	120 g
Housing color	Red
Type of fastening	Dovetail grooves
	Mounting thread
	Through-hole mounting
	Via optional mounting device

Technical data

Operation and display

Type of display	LED
Number of LEDs	2 Piece(s)

Environmental data

Ambient temperature, operation	0 ... 40 °C
Ambient temperature, storage	-20 ... 60 °C
Relative humidity (non-condensing)	0 ... 90 %

Certifications

Degree of protection	IP 67
Protection class	III
Certifications	c UL US
Test procedure for EMC in accordance with standard	EN 61000-6-2, -3
Test procedure for shock in accordance with standard	IEC 60068-2-27, test Ea
Test procedure for vibration in accordance with standard	IEC 60068-2-6, test Fc
US patents	US 6,735,007 B

Classification

Customs tariff number	84719000
ECLASS 5.1.4	27280102
ECLASS 8.0	27280102
ECLASS 9.0	27280102
ECLASS 10.0	27280102
ECLASS 11.0	27280102
ECLASS 12.0	27280102
ECLASS 13.0	27280102
ETIM 5.0	EC002550
ETIM 6.0	EC002550
ETIM 7.0	EC002550
ETIM 8.0	EC002550

Dimensioned drawings

All dimensions in millimeters

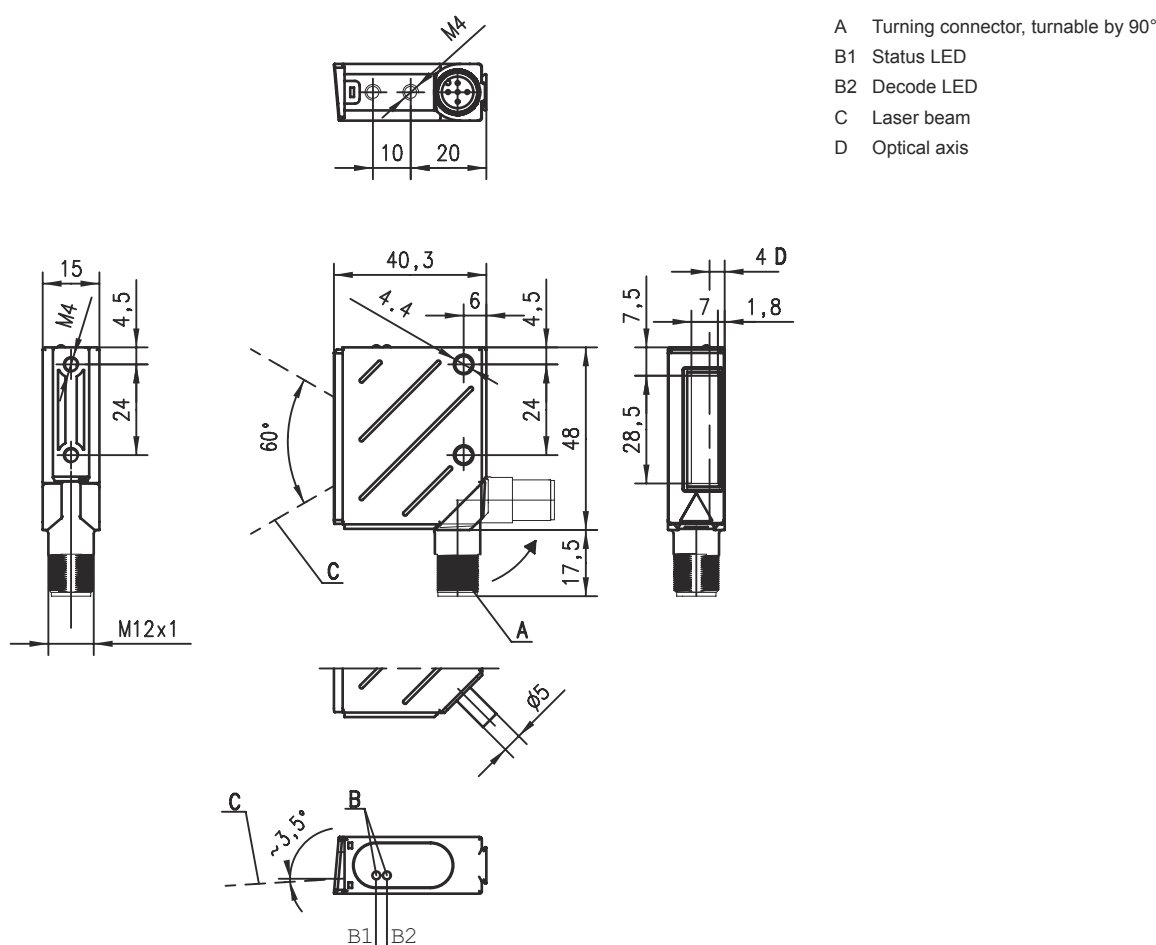

Electrical connection

Connection 1

Function	Data interface
	PWR / SW IN / OUT
Type of connection	Connector
Thread size	M12
Type	Male
Material	Metal
No. of pins	5 -pin
Encoding	A-coded

Pin	Pin assignment
1	+5 V DC
2	RS 232 TxD
3	GND
4	RS 232 RxD
5	SW IN/OUT

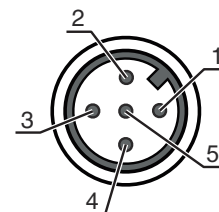

Diagrams

Reading field curve

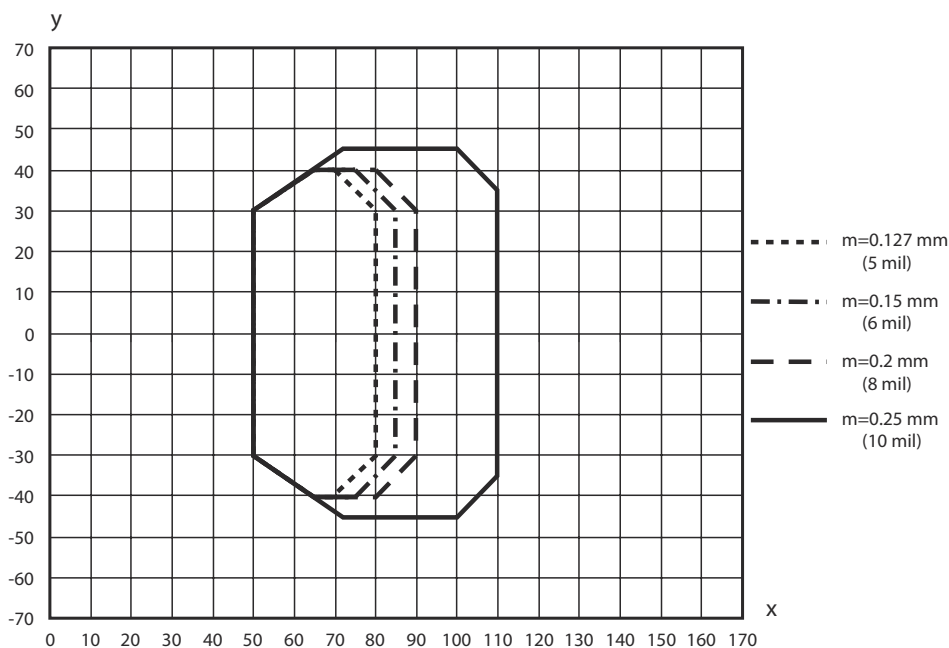

x Reading field distance [mm]
 y Reading field width [mm]

Operation and display

LED	Display	Meaning
1	Green, flashing	Device ok, initialization phase
	Green, continuous light	Operational readiness
	Red, flashing	Device OK, warning set
	Red, continuous light	Device error

Operation and display

LED	Display	Meaning
1	Orange, flashing	Service operation
2	Green, continuous light	Reading successful
	Red, continuous light	No reading result
	Orange, continuous light	Reading gate active

Notes

Observe intended use!

	⌘ This product is not a safety sensor and is not intended as personnel protection.
	⌘ The product may only be put into operation by competent persons.
	⌘ Only use the product in accordance with its intended use.

For UL applications:

	⌘ For UL applications, use is only permitted in Class 2 circuits in accordance with the NEC (National Electric Code).
--	---

ATTENTION! LASER RADIATION – CLASS 1 LASER PRODUCT

	The device satisfies the requirements of IEC/EN 60825-1:2014 safety regulations for a product of laser class 1 and complies with 21 CFR 1040.10 except for conformance with IEC 60825-1 Ed. 3., as described in Laser Notice No. 56, dated May 8, 2019.
	⌘ Observe the applicable statutory and local laser protection regulations.
	⌘ The device must not be tampered with and must not be changed in any way. There are no user-serviceable parts inside the device. Repairs must only be performed by Leuze electronic GmbH + Co. KG.



Accessories

Connection technology - Connection unit

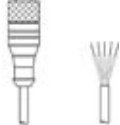

	Part no.	Designation	Article	Description
	50104790	MA 8-01	Modular connection unit	Supply voltage: 10 ... 30 V Current consumption, max.: 50 mA Interface: RS 485 Connections: 3 Piece(s) Degree of protection: IP 67
	50101699	MA 8.1	Modular connection unit	Supply voltage: 10 ... 30 V Current consumption, max.: 50 mA Interface: RS 232 Connections: 3 Piece(s) Degree of protection: IP 67

Accessories

Connection technology - Connection cables

	Part no.	Designation	Article	Description
 	50040757	KB 008-3000 A	Connection cable	Connection 1: Connector, M12, Axial, Female, A-coded, 5 -pin Connector, LED: No Connection 2: Open end Shielded: Yes Cable length: 3.000 mm Sheathing material: PUR
 	50101941	KB-008-3000 A-S	Connection cable	Connection 1: Connector, M12, Axial, Male, A-coded, 5 -pin Connector, LED: No Connection 2: Open end Shielded: Yes Cable length: 3.000 mm Sheathing material: PUR

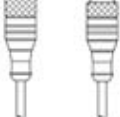

Connection technology - Interconnection cables

	Part no.	Designation	Article	Description
  	50133891	KDS S-M12-5A-M12-5A-P1-030	Interconnection cable	Connection 1: Connector, M12, Axial, Female, A-coded, 5 -pin Connection 2: Connector, M12, Axial, Male, A-coded, 5 -pin Shielded: Yes Cable length: 3,000 mm Sheathing material: PUR

Mounting technology - Rod mounts

	Part no.	Designation	Article	Description
	50127177	BTU 008M-D10	Mounting system	Design of mounting device: Mounting system Fastening, at system: Sheet-metal mounting, For 10 mm rod Mounting bracket, at device: Screw type Type of mounting device: Turning, 360°, Adjustable, Clampable Material: Metal

Mounting technology - Other

	Part no.	Designation	Article	Description
	50036196	BT 8-0	Mounting device	Design of mounting device: Mounting clamp Fastening, at system: Mounting thread Mounting bracket, at device: Clampable Type of mounting device: Rigid Material: Metal Shock absorber: No
	50104791	BT 8-01	Mounting device	Fastening, at system: Through-hole mounting Mounting bracket, at device: Screw type Material: Metal

Accessories

Note



🔗 A list with all available accessories can be found on the Leuze website in the Download tab of the article detailed page.