

## Technical data sheet Bar code positioning system

Part no.: 50136334

BPS 307i SM 100 H

### Contents

- Technical data
- Dimensioned drawings
- Diagrams
- Part number code
- Notes
- Accessories



Figure can vary



## Technical data

### Basic data

|             |  |
|-------------|--|
| Series      | BPS 300i   |
| Order guide | Bar code tape must be ordered separately<br>Operation only possible in combination with MS 3xx, MK 3xx or KB 30x connection unit |

### Functions

|           |         |
|-----------|---------|
| Functions | Heating |
|-----------|---------|

### Characteristic parameters

|      |          |
|------|----------|
| MTTF | 83 years |
|------|----------|

### Optical data

|                          |  |
|--------------------------|--|
| Depth of field           | 50 ... 170 mm  |
| Light source             | Laser, Red   |
| Wavelength               | 655 nm   |
| Laser class              | 1, in accordance with IEC 60825-1:2014 (EN 60825-1:2014) |
| Transmitted-signal shape | Continuous   |
| Light beam exit          | Lateral  |

### Measurement data

|                           |                     |
|---------------------------|---------------------|
| Measurement range         | 0 ... 10,000,000 mm |
| Resolution                | 0.01 ... 10 mm      |
| Reproducibility (1 sigma) | 0.05 mm             |
| Measurement value output  | 0.05 ... 2 ms       |
| Max. traverse rate        | 10 m/s              |

### Electrical data

|                    |   |
|--------------------|---|
| Protective circuit | Polarity reversal protection<br>Short circuit protected |
|--------------------|---|

#### Performance data

|                         |                 |
|-------------------------|-----------------|
| Supply voltage $U_B$    | 18 ... 30 V, DC |
| Power consumption, max. | 17.7 W          |

#### Inputs/outputs selectable

|                                     |                 |
|-------------------------------------|-----------------|
| Output current, max.                | 60 mA           |
| Number of inputs/outputs selectable | 2 Piece(s)      |
| Input current, max.                 | 8 mA            |
| Switching element                   | Transistor, PNP |

### Interface

|                 |                |
|-----------------|----------------|
| Type            | SSI            |
| SSI             |                |
| Function        | Process        |
| Clock frequency | 50 ... 800 kHz |
| Data bit        | Adjustable     |

### Service interface

|      |     |
|------|-----|
| Type | USB |
|------|-----|

### USB

|          |   |
|----------|---|
| Function | Configuration/parameterization via integrated web server<br>Service |
|----------|---|

### Mechanical data

|                       |   |
|-----------------------|---|
| Design                | Cubic   |
| Dimension (W x H x L) | 100 mm x 108.7 mm x 48.3 mm   |
| Housing material      | Metal   |
| Metal housing         | Diecast aluminum  |
| Lens cover material   | Glass   |
| Net weight            | 580 g   |
| Housing color         | Red<br>Silver   |
| Type of fastening     | Dovetail grooves<br>Fastening on back<br>Via optional mounting device |

### Operation and display

|                       |                 |
|-----------------------|-----------------|
| Type of display       | LED             |
| Type of configuration | Via web browser |

### Environmental data

|                                    |               |
|------------------------------------|---------------|
| Ambient temperature, operation     | -35 ... 50 °C |
| Ambient temperature, storage       | -35 ... 70 °C |
| Relative humidity (non-condensing) | 90 %          |

### Certifications

|   |  |
|---|--|
| Degree of protection  | IP 65, EN 60529 with various connectors or screwed-on caps |
| Protection class  | III  |
| Certifications  | c UL US  |
| Test procedure for EMC in accordance with standard              | EN 61000-6-2<br>EN 61000-6-3                               |
| Test procedure for shock in accordance with standard            | IEC 60068-2-27, test Ea                                    |
| Test procedure for continuous shock in accordance with standard | IEC 60068-2-29, test Eb                                    |
| Test procedure for vibration in accordance with standard        | IEC 60068-2-6, test Fc                                     |

### Classification

|                       |          |
|-----------------------|----------|
| Customs tariff number | 84719000 |
| ECLASS 5.1.4          | 27280190 |
| ECLASS 8.0            | 27280190 |
| ECLASS 9.0            | 27280190 |
| ECLASS 10.0           | 27280190 |
| ECLASS 11.0           | 27280190 |
| ECLASS 12.0           | 27280106 |
| ECLASS 13.0           | 27280106 |
| ETIM 5.0              | EC001825 |
| ETIM 6.0              | EC001825 |
| ETIM 7.0              | EC001825 |
| ETIM 8.0              | EC001825 |

## Dimensioned drawings

All dimensions in millimeters

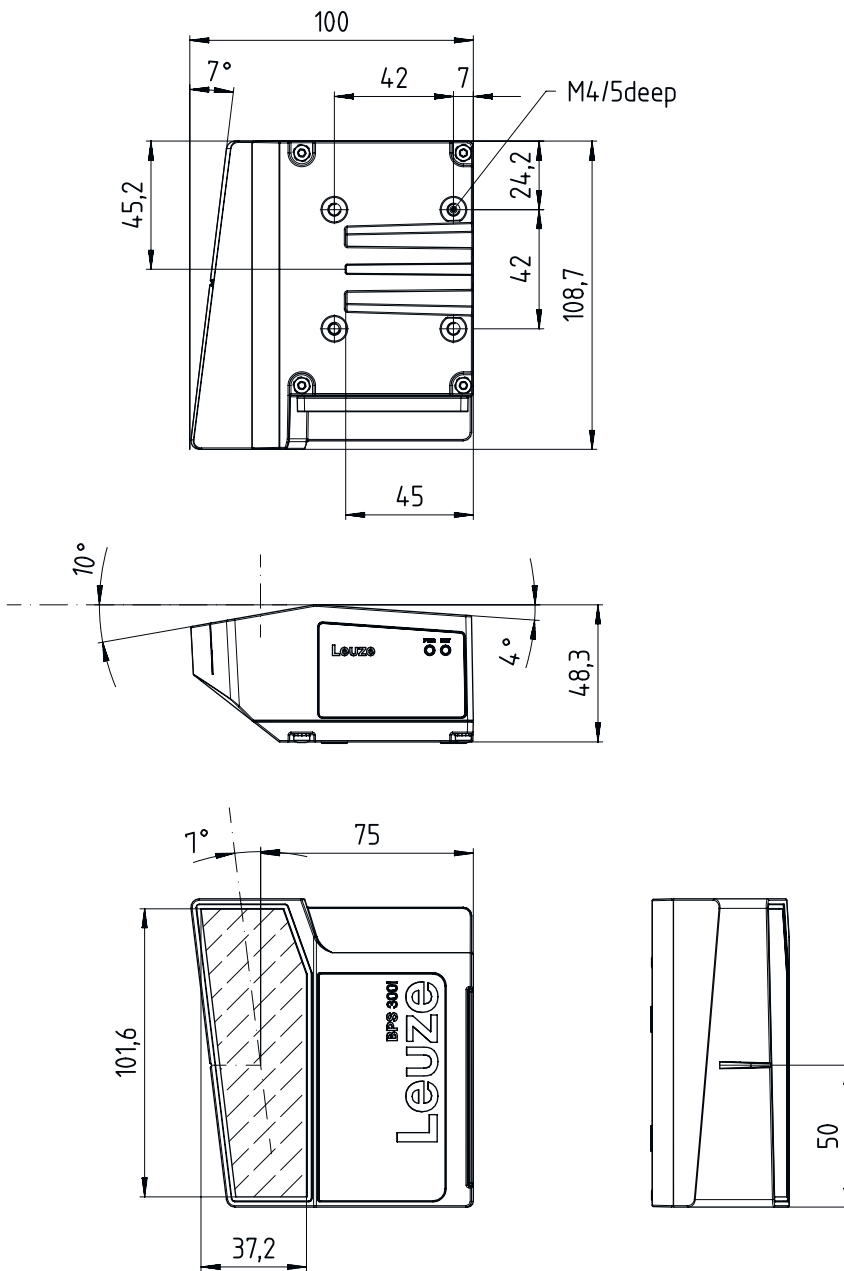

# Diagrams

## Reading field curve



x Reading field distance [mm]  
 y Reading field width [mm]

## Part number code

Part designation: **BPS 3XXi SM 100 Y Z AA**

|             |  |
|-------------|--|
| <b>BPS</b>  | <b>Operating principle</b><br>BPS: bar code positioning system   |
| <b>3XXi</b> | <b>Series/interface (integrated fieldbus technology)</b><br>300i: RS 232 / RS 422 (stand-alone)<br>301i: RS 485<br>304i: PROFIBUS DP<br>307i: SSI<br>348i: PROFINET RT |
| <b>SM</b>   | <b>Scanning principle / optics</b><br>S: line scanner (single line)  |
| <b>100</b>  | <b>Beam exit</b><br>100: lateral   |

# Part number code

|    |   |
|----|---|
| YZ | <b>Special equipment</b><br>n/a: no special equipment<br>D: With display<br>H: With heating<br>D H: optionally with display and heating |
| AA | <b>Switching element</b><br>n/a: Transistor, PNP<br>02: Transistor, NPN   |

| Note |  |
|------|--|
|      | ↪ A list with all available device types can be found on the Leuze website at <a href="http://www.leuze.com">www.leuze.com</a> . |

## Notes

| ⚠ Observe intended use! |   |
|-------------------------|---|
|                         | ↪ This product is not a safety sensor and is not intended as personnel protection.<br>↪ The product may only be put into operation by competent persons.<br>↪ Only use the product in accordance with its intended use. |

| ⚠ ATTENTION! LASER RADIATION – CLASS 1 LASER PRODUCT |   |
|--|---|
|  | The device satisfies the requirements of IEC/EN 60825-1:2014 safety regulations for a product of <b>laser class 1</b> and complies with 21 CFR 1040.10 except for conformance with IEC 60825-1 Ed. 3., as described in Laser Notice No. 56, dated May 8, 2019.<br>↪ Observe the applicable statutory and local laser protection regulations.<br>↪ The device must not be tampered with and must not be changed in any way.<br>There are no user-serviceable parts inside the device.<br>Repairs must only be performed by Leuze electronic GmbH + Co. KG. |

## Accessories

### Connection technology - Connection cables

|  | Part no. | Designation        | Article          | Description   |
|--|----------|--------------------|------------------|---|
|  | 50104172 | KB SSI/IBS-2000-BA | Connection cable | Suitable for interface: SSI, Interbus-S<br>Connection 1: Connector, M12, Axial, Female, B-coded, 5 -pin<br>Connector, LED: No<br>Connection 2: Open end<br>Shielded: Yes<br>Cable length: 2.000 mm<br>Sheathing material: PUR |
|  | 50132077 | KD U-M12-5A-V1-020 | Connection cable | Connection 1: Connector, M12, Axial, Female, A-coded, 5 -pin<br>Connector, LED: No<br>Connection 2: Open end<br>Shielded: No<br>Cable length: 2.000 mm<br>Sheathing material: PVC   |

## Accessories

|   | Part no. | Designation        | Article          | Description   |
|---|----------|--------------------|------------------|---|
|  | 50132079 | KD U-M12-5A-V1-050 | Connection cable | Connection 1: Connector, M12, Axial, Female, A-coded, 5 -pin<br>Connector, LED: No<br>Connection 2: Open end<br>Shielded: No<br>Cable length: 5.000 mm<br>Sheathing material: PVC |

## Connection technology - Interconnection cables



|   | Part no.   | Designation | Article               | Description  |
|---|------------|-------------|-----------------------|--|
|  | 50126132 * | KB 307-3000 | Interconnection cable | Suitable for interface: SSI<br>Parameter memory: No<br>Connection 1: Socket connector<br>Connection 2: Socket connector, 10 -pin, 6 -pin<br>Shielded: Yes<br>Cable length: 3,000 mm<br>Sheathing material: PVC |

\* Necessary accessories, please order separately

## Connection technology - Connectors

|  | Part no. | Designation | Article   | Description   |
|--|----------|-------------|-----------|---|
|  | 50020501 | KD 095-5A   | Connector | Connection: Connector with screw terminals, M12, Axial, Female, A-coded, 5 -pin |

## Connection technology - Connection boxes

|  | Part no.   | Designation | Article         | Description  |
|--|------------|-------------|-----------------|--|
|  | 50126131 * | MK 307      | Connection unit | Suitable for: BPS 307i<br>Parameter memory: Yes<br>Interface: SSI<br>Number of connections: 3 Piece(s)<br>Connection: Terminal       |
|  | 50126130 * | MS 307      | Connection unit | Suitable for: BPS 307i<br>Parameter memory: Yes<br>Interface: SSI<br>Number of connections: 3 Piece(s)<br>Connection: Connector, M12 |

\* Necessary accessories, please order separately

## Accessories



### Mounting technology - Rod mounts

|  | Part no. | Designation | Article         | Description   |
|--|----------|-------------|-----------------|---|
|  | 50027375 | BT 56       | Mounting device | Functions: Static applications<br>Design of mounting device: Mounting system<br>Fastening, at system: For 16 mm rod, For 18 mm rod, For 20 mm rod<br>Mounting bracket, at device: Clampable<br>Material: Metal<br>Tightening torque of the clamping jaws: 8 N·m |



### Mounting technology - Other

|   | Part no. | Designation | Article         | Description   |
|---|----------|-------------|-----------------|---|
|  | 50124941 | BTU 0300M-W | Mounting device | Fastening, at system: Through-hole mounting<br>Mounting bracket, at device: Clampable, Groove mounting, Suited for M4 screws<br>Material: Metal<br>Shock absorber: No |

### Bar code tape

|  | Part no. | Designation      | Article       | Description  |
|--|----------|------------------|---------------|--|
|  | 50144190 | BCB G40 H25 L010 | Bar code tape | Dimensions: 25 mm x 10,000 mm<br>Grid dimension: 40 mm |
|  | 50040041 | BCB G40 H47 L010 | Bar code tape | Dimensions: 47 mm x 10,000 mm<br>Grid dimension: 40 mm |

### Services

|  | Part no. | Designation | Article          | Description   |
|--|----------|-------------|------------------|---|
|  | S981001  | CS10-S-110  | Start-up support | Details: Performed at location of customer's choosing, duration: max. 10 hours.<br>Conditions: Devices and connection cables are already mounted, price not including travel costs and, if applicable, accommodation expenses.<br>Restrictions: No mechanical (mounting) and electrical (wiring) work performed, no changes (attachments, wiring, programming) to third-party components in the nearby environment. |
|  | S981005  | CS10-T-110  | Product training | Details: Location and content to be agreed upon, duration: max. 10 hours.<br>Conditions: Price not including travel costs and, if applicable, accommodation expenses.<br>Restrictions: Travel costs and accommodation expenses charged separately and according to expenditure.   |

#### Note



A list with all available accessories can be found on the Leuze website in the Download tab of the article detailed page.