

## Technical data sheet

### Stationary 2D-code reader

Part no.: 50146009  
DCR 258i FIX-M1-102-I3-G

#### Contents

- Technical data
- Dimensioned drawings
- Electrical connection
- Diagrams
- Operation and display
- Part number code
- Notes
- Accessories



Figure can vary



## Technical data

### Basic data

Series	DCR 200i
--------	----------

### Functions

Software functions	Reading of 1D codes
	Reading of 2D codes

### Read data

Code types, readable	2/5 Interleaved
	Aztec
	Codabar
	Code 128
	Code 32
	Code 39
	Code 93
	Data Matrix Code
	EAN 128
	EAN 8/13
	GS1 Databar
	GS1 Databar Omnidirectional
	GS1 Databar QR code
	GS1 Databar Stacked
	PDF417
	Pharma Code
	QR code
	UPC

### Optical data

Reading distance	50 ... 220 mm
Light source	LED, Infrared
Transmitted-signal shape	Pulsed
Camera resolution, horizontal	1,280 px
Camera resolution, vertical	960 px
Modulus size	0.19 ... 0.5 mm
Electronic shutter speed	0.068 ... 5 ms
Camera type	Monochrome

### Electrical data

Protective circuit	Polarity reversal protection
	Short circuit protected

#### Performance data

Supply voltage $U_B$	18 ... 30 V, DC
Average power consumption	8 W

#### Inputs

Number of digital switching inputs	1 Piece(s)
------------------------------------	------------

#### Switching inputs

Voltage type	DC
--------------	----

#### Outputs

Number of digital switching outputs	1 Piece(s)
-------------------------------------	------------

#### Switching outputs

Voltage type	DC
Switching current, max.	100 mA

#### Switching output 1

Switching element	MOSFET semiconductor
Switching principle	+24 V switching

### Inputs/outputs selectable

Number of inputs/outputs selectable	2 Piece(s)
Voltage type, outputs	DC
Voltage type, inputs	DC

### Interface

Type	RS 232, RS 422, EtherNet IP, Ethernet
------	---------------------------------------

#### RS 232

Function	Process
Transmission speed	4,800 ... 115,200 Bd
Data format	Adjustable
Start bit	1
Data bit	8
Stop bit	1
Parity	None
Transmission protocol	<STX><data><CR><LF>
Data encoding	ASCII
	Binary

#### RS 422

Function	Process
Transmission speed	4,800 ... 115,200 Bd
Data format	Adjustable
Start bit	1
Data bit	7, 8 data bits
Stop bit	1, 2 stop bits
Parity	Adjustable
Data encoding	ASCII
	Binary

#### EtherNet IP

Address assignment	DHCP
	Manual address assignment
Function	Process
Switch functionality	None
Transmission speed	10 Mbit/s
	100 Mbit/s

#### Ethernet

Architecture	Client
	Server
Address assignment	DHCP
	Manual address assignment
Transmission speed	10 / 100 Mbit/s
Function	Process
Switch functionality	None
Transmission protocol	TCP/IP, UDP

### Service interface

Type	Ethernet
------	----------

#### Ethernet

Function	Service
----------	---------

### Connection

Number of connections	2 Piece(s)
-----------------------	------------

## Technical data

### Connection 1

<b>Function</b>	Data interface
	Signal IN
	Signal OUT
	Voltage supply
<b>Type of connection</b>	Connector
<b>Thread size</b>	M12
<b>Type</b>	Male
<b>Material</b>	Metal
<b>No. of pins</b>	12 -pin
<b>Encoding</b>	A-coded

### Connection 2

<b>Function</b>	Configuration interface
	Data interface
<b>Type of connection</b>	Connector
<b>Thread size</b>	M12
<b>Type</b>	Female
<b>Material</b>	Metal
<b>No. of pins</b>	4 -pin
<b>Encoding</b>	D-coded

### Mechanical data

<b>Design</b>	Cubic
<b>Dimension (W x H x L)</b>	43 mm x 61 mm x 44 mm
<b>Housing material</b>	Metal
	Plastic
<b>Metal housing</b>	Diecast aluminum
<b>Plastic housing</b>	PC
<b>Lens cover material</b>	Glass
<b>Net weight</b>	120 g
<b>Housing color</b>	Silver
<b>Type of fastening</b>	Mounting thread
	Via optional mounting device

### Operation and display

<b>Type of display</b>	LED
<b>Number of LEDs</b>	10 Piece(s)
<b>Type of configuration</b>	Configuration codes
	Teach-in
	Via web browser
<b>Operational controls</b>	Button(s)
<b>Function of the operational control</b>	Adjustment mode
	Auto-setup
	Trigger

### Environmental data

<b>Ambient temperature, operation</b>	0 ... 45 °C
<b>Ambient temperature, storage</b>	-20 ... 70 °C
<b>Relative humidity (non-condensing)</b>	90 %

### Certifications

<b>Degree of protection</b>	IP 65
<b>Protection class</b>	III
<b>Certifications</b>	c UL US
<b>Test procedure for EMC in accordance with standard</b>	EN 61000-6-2
	EN 61000-6-4
<b>Test procedure for continuous shock in accordance with standard</b>	IEC 60068-2-29, test Eb
<b>Test procedure for vibration in accordance with standard</b>	IEC 60068-2-6, test Fc

### Classification

<b>Customs tariff number</b>	84719000
<b>ECLASS 5.1.4</b>	27280103
<b>ECLASS 8.0</b>	27280103
<b>ECLASS 9.0</b>	27280103
<b>ECLASS 10.0</b>	27280103
<b>ECLASS 11.0</b>	27280103
<b>ECLASS 12.0</b>	27280103
<b>ECLASS 13.0</b>	27280103
<b>ETIM 5.0</b>	EC002550
<b>ETIM 6.0</b>	EC002999
<b>ETIM 7.0</b>	EC002999
<b>ETIM 8.0</b>	EC002999

# Dimensioned drawings

All dimensions in millimeters

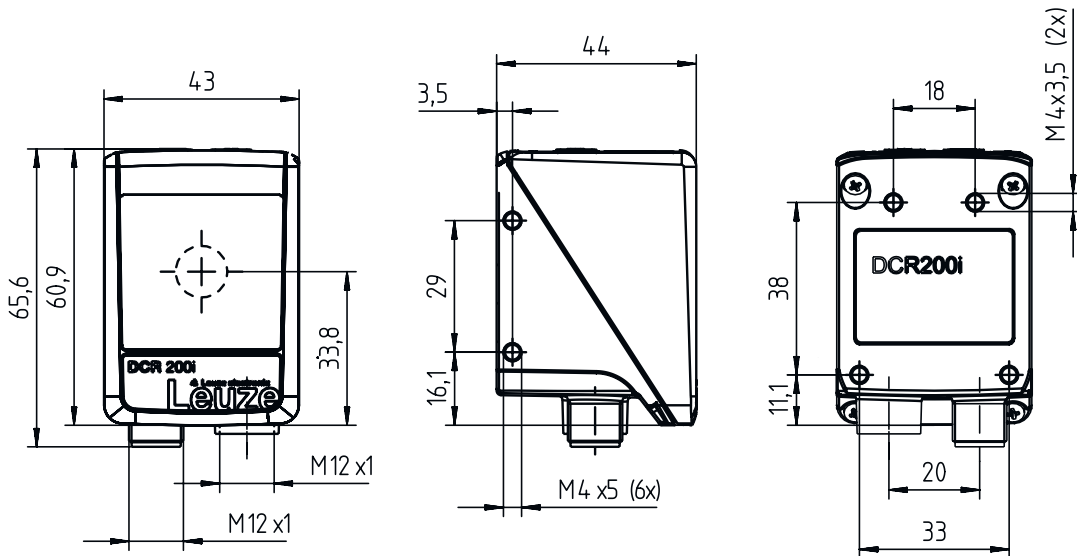

## Electrical connection

### Connection 1

### PWR / SWIO

<b>Function</b>	Data interface
	Signal IN
	Signal OUT
	Voltage supply
<b>Type of connection</b>	Connector
<b>Thread size</b>	M12
<b>Type</b>	Male
<b>Material</b>	Metal
<b>No. of pins</b>	12 -pin
<b>Encoding</b>	A-coded

Pin	Pin assignment
1	VIN
2	GNDIN
3	SWIN 1
4	SWOUT 2
5	FE
6	GND RS 232 / GND RS 422
7	Rx-
8	Tx-
9	RxD/Rx+
10	TxD/Tx+
11	SWIO 3
12	SWIO 4

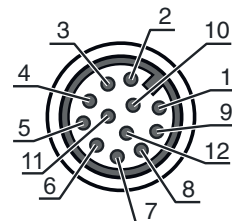

# Electrical connection

## Connection 2

## HOST

Function	Configuration interface Data interface
Type of connection	Connector
Thread size	M12
Type	Female
Material	Metal
No. of pins	4 -pin
Encoding	D-coded

Pin	Pin assignment
1	TD+
2	RD+
3	TD-
4	RD-



## Diagrams

### Reading distances

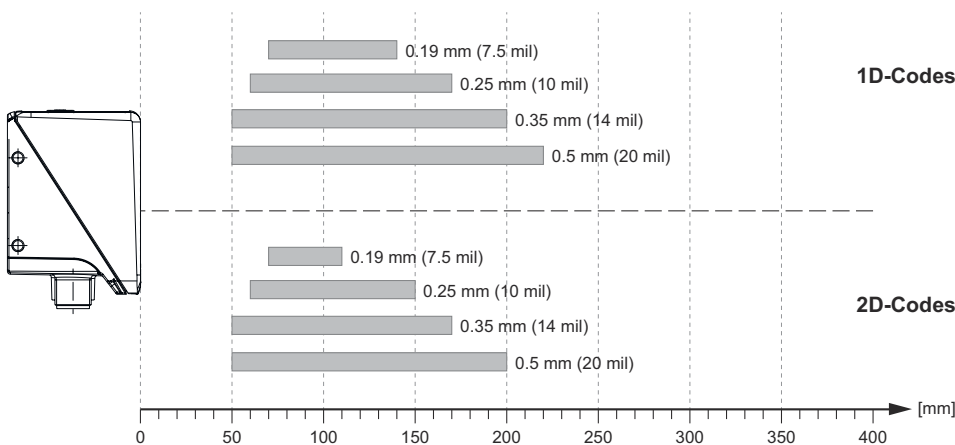

### Relationship between camera distance and reading field size



# Diagrams

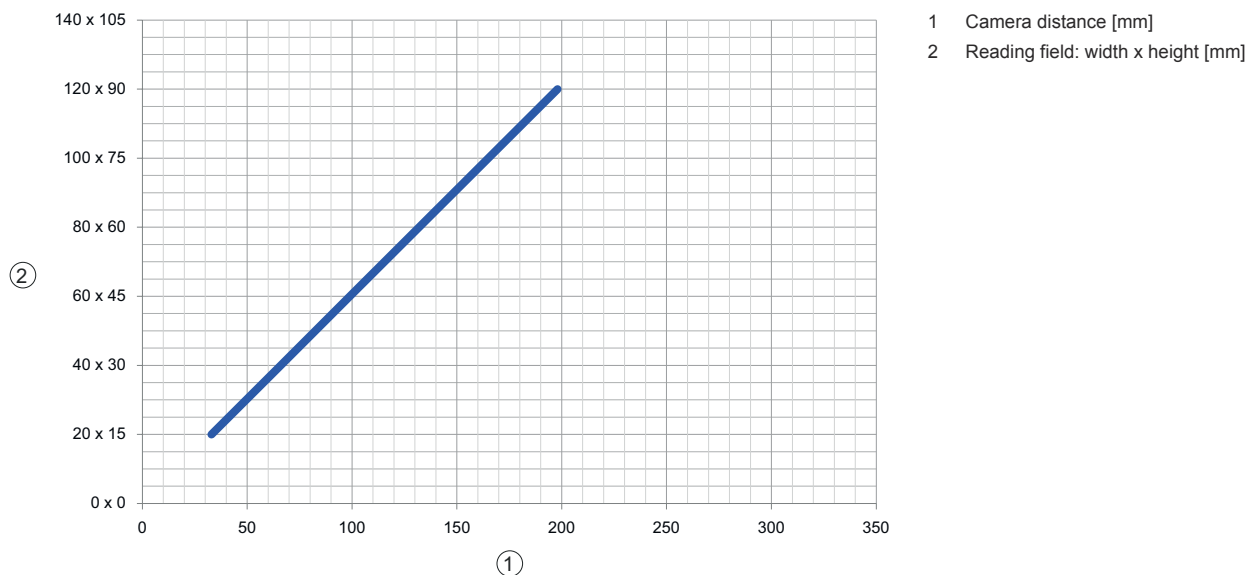

## Operation and display

LED	Display	Meaning
1 PWR	Off	No supply voltage
	Green, flashing	Initialization
	Green, continuous light	Operational readiness
	Orange, continuous light	Service operation
	Red, flashing	Device OK, warning set
	Red, continuous light	Device error
2 NET	Off	No supply voltage
	Green, flashing	Initialization
	Green, continuous light	Operational readiness
	Red, flashing	Communication error
3 LINK	Red, continuous light	Network error
	Green, continuous light	Ethernet connection is established
4 TRIG	Yellow, flashing	Data exchange active
	Green, flashing	Trigger and display of the read quality
5 AUTO	Green, flashing	Auto-setup and display of the read quality
6 ADJ	Green, flashing	Alignment mode and display of the read quality
7 TEACH	Green, flashing	Teach-in and display of the read quality
8	Green, flashing	Display of the reading quality
9	Green, flashing	Display of the reading quality
10	Green, flashing (behind lens cover)	Reading successful

# Part number code

Part designation: DCR XXX YYY-Z-AAA-BC-D-EEEE

<b>DCR</b>	<b>Operating principle</b> DCR: Dual Code Reader
<b>XXXX</b>	<b>Series/interface (integrated fieldbus technology)</b> 202i: Ethernet TCP/IP, UDP, RS 232/RS 422 248i: PROFINET-IO, Ethernet TCP/IP, UDP, RS 232/RS 422 202iC: Ethernet TCP/IP, UDP, RS 232/RS 422 (IoT / Industry 4.0 connectivity) 248iC: PROFINET-IO, Ethernet TCP/IP, UDP, RS 232/RS 422 (IoT / Industry 4.0 connectivity) 258i: EtherNet/IP
<b>YYY</b>	<b>Equipment</b> FIX: Fixed focal length
<b>Z</b>	<b>Optics</b> U: Ultra high density (very close) N: High Density (close) M: Medium Density (medium distance) F: Low Density (remote) L: Ultra low density (very large distance)
<b>AAA</b>	<b>Beam exit</b> 102: front
<b>B</b>	<b>Illumination</b> R: Red light I: infrared light
<b>C</b>	<b>Resolution range</b> 3: 1280 x 960 pixels
<b>D</b>	<b>Protective screen</b> n/a: plastic G: Glass P: Polarization filter
<b>EEEE</b>	<b>Special equipment</b> V: Stainless steel housing F001: NPN inputs/outputs F099: OPC-UA function H: With heating Xxxx: customer-specific model

## Note

	↪ A list with all available device types can be found on the Leuze website at <a href="http://www.leuze.com">www.leuze.com</a> .
--	--



## Notes

### Observe intended use!

	<ul style="list-style-type: none"> <li>↪ This product is not a safety sensor and is not intended as personnel protection.</li> <li>↪ The product may only be put into operation by competent persons.</li> <li>↪ Only use the product in accordance with its intended use.</li> </ul>
--	---

## Accessories

### Connection technology - Connection cables

	Part no.	Designation	Article	Description
	50130281	KD S-M12-CA-P1-020	Connection cable	Connection 1: Connector, M12, Axial, Female, A-coded, 12 -pin Connector, LED: No Connection 2: Open end Shielded: Yes Cable length: 2.000 mm Sheathing material: PUR
	50135073	KS ET-M12-4A-P7-020	Connection cable	Suitable for interface: Ethernet Connection 1: Connector, M12, Axial, Male, D-coded, 4 -pin Connector, LED: No Connection 2: Open end Shielded: Yes Cable length: 2.000 mm Sheathing material: PUR

### Connection technology - Interconnection cables

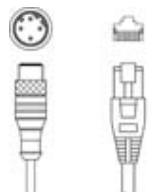
	Part no.	Designation	Article	Description
	50135080	KSS ET-M12-4A-RJ45-A-P7-020	Interconnection cable	Suitable for interface: Ethernet Connection 1: Connector, M12, Axial, Male, D-coded, 4 -pin Connection 2: RJ45 Shielded: Yes Cable length: 2,000 mm Sheathing material: PUR

### Mounting technology - Mounting brackets

	Part no.	Designation	Article	Description
	50132151	BT 320M	Mounting bracket	Design of mounting device: Angle, L-shape Fastening, at system: Through-hole mounting Mounting bracket, at device: Screw type Type of mounting device: Rigid Material: Metal

### Mounting technology - Rod mounts

	Part no.	Designation	Article	Description
	50132150	BTU 320M-D12	Mounting system	Design of mounting device: Mounting system Fastening, at system: For 12 mm rod Mounting bracket, at device: Screw type Type of mounting device: Clampable, Adjustable, Turning, 360° Material: Metal



## Accessories

### General

	Part no.	Designation	Article	Description
	50144030	IL AL 034/031 IR 110 H	Illumination	Special version: Heating Functions: Strobed operation (edge-triggered), no continuous operation

### Services

	Part no.	Designation	Article	Description
	S981014	CS30-S-110	Start-up support	Details: Performed at location of customer's choosing, duration: max. 10 hours. Conditions: Devices and connection cables are already mounted, price not including travel costs and, if applicable, accommodation expenses. Restrictions: No mechanical (mounting) and electrical (wiring) work performed, no changes (attachments, wiring, programming) to third-party components in the nearby environment.
	S981019	CS30-T-110	Product training	Details: Location and content to be agreed upon, duration: max. 10 hours. Conditions: Price not including travel costs and, if applicable, accommodation expenses. Restrictions: Travel costs and accommodation expenses charged separately and according to expenditure.

#### Note



↪ A list with all available accessories can be found on the Leuze website in the Download tab of the article detailed page.