

Technical data sheet

Optical data transmission

Part no.: 50134430

DDLS 548i 120.4 L

Contents

- Technical data
- Dimensioned drawings
- Electrical connection
- Operation and display
- Suitable transmitters
- Part number code
- Notes
- Accessories



For illustration purposes only



Technical data

Basic data

Series	DDLS 500
--------	----------

Special version

Special version	Integrated laser alignment aid
	Not influenced by reflective surfaces
	Operation of parallel light axes
	Remote diagnosis via web server

Optical data

Working range	100 ... 120,000 mm
Light source	Laser
Transmission frequency	F4
Usable opening angle transmitter	1 °

Electrical data

Performance data

Supply voltage U_B	18 ... 30 V, DC
----------------------	-----------------

Interface

Type	PROFINET
------	----------

PROFINET

Transmission speed	100 Mbit/s
--------------------	------------

Connection

Number of connections	2 Piece(s)
-----------------------	------------

Connection 1

Type of connection	Connector
Designation on device	POWER
Thread size	M12
Type	Male
No. of pins	5 -pin
Encoding	A-coded

Connection 2

Type of connection	Connector
Designation on device	BUS
Thread size	M12
Type	Female
No. of pins	4 -pin
Encoding	D-coded

Mechanical data

Dimension (W x H x L)	100 mm x 156 mm x 99.5 mm
Housing material	Metal
Net weight	1,255 g

Operation and display

Type of display	Bar graph
	LED
Type of configuration	GSDML file
	Software
	Via web browser

Environmental data

Ambient temperature, operation	-5 ... 50 °C
Ambient temperature, storage	-35 ... 70 °C

Certifications

Degree of protection	IP 65
Certifications	c UL US
Test procedure for EMC in accordance with standard	EN 1000-6-4
	EN 61000-6-2
Test procedure for noise in accordance with standard	EN 60068-2-64
Test procedure for oscillation in accordance with standard	EN 60068-2-6
Test procedure for shock in accordance with standard	EN 60068-2-27

Classification

Customs tariff number	85365019
ECLASS 5.1.4	19039001
ECLASS 8.0	19179090
ECLASS 9.0	19179090
ECLASS 10.0	19179090
ECLASS 11.0	19179090
ECLASS 12.0	19179090
ECLASS 13.0	19179090
ETIM 5.0	EC000515
ETIM 6.0	EC000515
ETIM 7.0	EC000310
ETIM 8.0	EC000310

Dimensioned drawings

All dimensions in millimeters

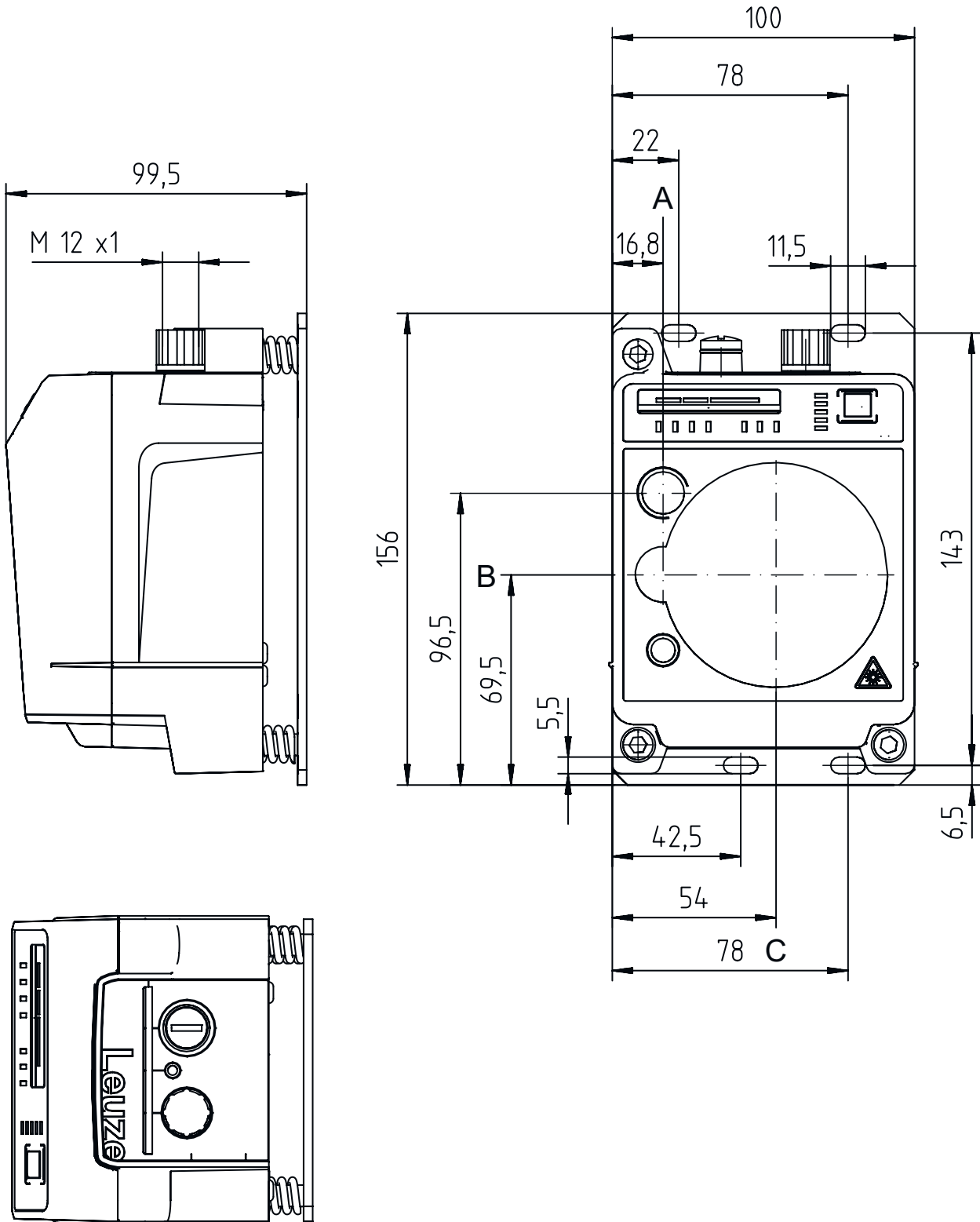

- A Center axis of transmitter and alignment laser
- B Center axis of transmitter and receiver
- C Center axis of receiver

Electrical connection

Connection 1

POWER

Function	Signal IN Signal OUT Voltage supply
Type of connection	Connector
Thread size	M12
Type	Male
Material	Metal
No. of pins	5 -pin
Encoding	A-coded

Pin Pin assignment

1	VIN
2	IO1
3	GND
4	IO2
5	FE/SHIELD



Connection 2

BUS

Function	BUS IN
Type of connection	Connector
Thread size	M12
Type	Female
Material	Metal
No. of pins	4 -pin
Encoding	D-coded

Pin Pin assignment

1	TD+
2	RD+
3	TD-
4	RD-



Operation and display

LED	Display	Meaning
1 AUT	Off	Operating mode not active
	Green, continuous light	Operating mode "Automatic"
2 MAN	Off	Operating mode not active
	Green, continuous light	Operating mode "Manual"
3 ADJ	Off	Operating mode not active
	Green, continuous light	Operating mode "Adjust"
4 LAS	Off	Operating mode not active
	Green, continuous light	Operating mode "Alignment-laser mounting support"
5 LLC	Off	Operating mode not active
	Green, continuous light	LLC without interruption
	Red, continuous light	LLC interrupted at least once
6 PWR	Off	No supply voltage
	Green, flashing	Device ok, initialization phase
	Green, continuous light	Data transmission active
	Red, flashing	Data transmission interrupted
	Red, continuous light	Device error
7 TMP	Off	Operating temperature OK
	Orange, continuous light	Operating temperature critical

Operation and display

LED	Display	Meaning
7 TMP	Red, continuous light	Operating temperature exceeded or not met
8 LSR	Off	With function reserve
	Orange, continuous light	Device OK, warning set
9 BUS	Off	No supply voltage
	Green, flashing	Device waiting for communication to be re-established, no data exchange
	Green, continuous light	Communication with IO-Controller established, data exchange active
	Orange, flashing	PROFINET wave function activated, the PWR and BUS LEDs flash in sync in orange
	Red, flashing	Parameterization or configuration failed, no data exchange
	Red, continuous light	Bus error, no communication established to the IO controller
10 OLK	Off	Fault
	Green, continuous light	No data transmission
	Orange, continuous light	Data transmission active
11 ERL	Off	Link OK
	Orange, continuous light	Missing link (Ethernet cable connection) on the second device
	Red, continuous light	No cable-connected link to the connected device
12 LINK	Off	No cable-connected link to the connected device
	Green, continuous light	Link OK
	Orange, continuous light	Data transmission active
13 SIGNAL QUALITY	2 red, 2 orange and 4 green	Received signal level

Suitable transmitters

	Part no.	Designation	Article	Description
	50134429	DDLS 548i 120.3 L	Optical data transmission	Special version: Operation of parallel light axes, Ferndiagnose über Webserver, Integrated laser alignment aid, Not influenced by reflective surfaces Working range: 100 ... 120.000 mm Transmission frequency: F3 Interface: PROFINET Connection: Connector, M12

Part number code

Part designation: **DDLS 5XXX YYY.Z A B CC**

DDLS	Optical transceiver for digital data transmission
5XXX	Series 508i: without integrated web server for remote diagnostics 508i: with integrated web server for remote diagnostics 538: without integrated web server for remote diagnostics (EtherCAT) 548i: with integrated web server for remote diagnostics
YYY	Range for data transmission in m
Z	Frequency of the transmitter 0: Frequency F0 1: Frequency F1 2: Frequency F2 3: Frequency F3 4: Frequency F4
A	Option L: integrated laser alignment aid (for transmitter/receiver) n/a: standard

Part number code

B	Special equipment H: With heating n/a: no special equipment
CC	Special equipment W: transmission optics with larger opening angle (on request) n/a: no special equipment

Note

	<ul style="list-style-type: none"> ↪ A list with all available device types can be found on the Leuze website at www.leuze.com.
--	---

Notes

Observe intended use!

	<ul style="list-style-type: none"> ↪ This product is not a safety sensor and is not intended as personnel protection. ↪ The product may only be put into operation by competent persons. ↪ Only use the product in accordance with its intended use.
--	---

For UL applications:

	<ul style="list-style-type: none"> ↪ For UL applications, use is only permitted in Class 2 circuits in accordance with the NEC (National Electric Code).
--	---

ATTENTION! INVISIBLE LASER RADIATION – CLASS 1M LASER PRODUCT

	<p>Do not expose users of telescopic optics! The device satisfies the requirements of IEC 60825-1:2007 (EN 60825-1:2007) safety regulations for a product of laser class 1M as well as the U.S. 21 CFR 1040.10 regulations with deviations corresponding to Laser Notice No. 50 from June 24, 2007.</p> <ul style="list-style-type: none"> ↪ Do not expose users of telescopic optics! The device satisfies the requirements of IEC 60825-1:2007 (EN 60825-1:2007) safety regulations for a product of laser class 1M as well as the U.S. 21 CFR 1040.10 regulations with deviations corresponding to Laser Notice No. 50 from June 24, 2007. ↪ Looking into the beam path for extended periods using telescope optics may damage the eye's retina. Never look using telescope optics into the laser beam or in the direction of reflecting beams. ↪ CAUTION! The use of operating and adjusting devices other than those specified here or the carrying out of differing procedures may lead to dangerous exposure to radiation! The use of optical instruments or devices (e.g., magnifying glasses, binoculars) in combination with the device increases the danger of eye damage. ↪ Observe the applicable statutory and local laser protection regulations. ↪ The device must not be tampered with and must not be changed in any way. There are no user-serviceable parts inside the device. Repairs must only be performed by Leuze electronic GmbH + Co. KG.
--	---

Notes



ATTENTION! LASER RADIATION – CLASS 1 LASER PRODUCT (alignment laser)



The device satisfies the requirements of IEC 60825-1:2007 (EN 60825-1:2007) safety regulations for a product of **laser class 1** as well as the U.S. 21 CFR 1040.10 regulations with deviations corresponding to Laser Notice No. 50 from June 24, 2007.



☞ The device satisfies the requirements of IEC 60825-1:2007 (EN 60825-1:2007) safety regulations for a product of **laser class 1** as well as the U.S. 21 CFR 1040.10 regulations with deviations corresponding to Laser Notice No. 50 from June 24, 2007.

☞ Observe the applicable statutory and local laser protection regulations.

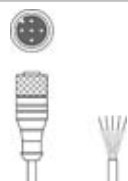

☞ The device must not be tampered with and must not be changed in any way.
There are no user-serviceable parts inside the device.
Repairs must only be performed by Leuze electronic GmbH + Co. KG.

Accessories

Connection technology - Connection cables

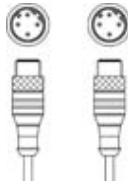

	Part no.	Designation	Article	Description
	50132079	KD U-M12-5A-V1-050	Connection cable	Connection 1: Connector, M12, Axial, Female, A-coded, 5 -pin Connector, LED: No Connection 2: Open end Shielded: No Cable length: 5.000 mm Sheathing material: PVC
	50135074	KS ET-M12-4A-P7-050	Connection cable	Suitable for interface: Ethernet Connection 1: Connector, M12, Axial, Male, D-coded, 4 -pin Connector, LED: No Connection 2: Open end Shielded: Yes Cable length: 5.000 mm Sheathing material: PUR

Connection technology - Interconnection cables

	Part no.	Designation	Article	Description
	50137078	KSS ET-M12-4A-M12-4A-P7-050	Interconnection cable	Suitable for interface: Ethernet Connection 1: Connector, M12, Axial, Male, D-coded, 4 -pin Connection 2: Connector, M12, Axial, Male, D-coded, 4 -pin Shielded: Yes Cable length: 5,000 mm Sheathing material: PUR
	50135081	KSS ET-M12-4A-RJ45-A-P7-050	Interconnection cable	Suitable for interface: Ethernet Connection 1: Connector, M12, Axial, Male, D-coded, 4 -pin Connection 2: RJ45 Shielded: Yes Cable length: 5,000 mm Sheathing material: PUR

Accessories

Connection technology - Connectors

	Part no.	Designation	Article	Description
	50020501	KD 095-5A	Connector	Connection: Connector with screw terminals, M12, Axial, Female, A-coded, 5-pin
	50112155	S-M12A-ET	Connector	Suitable for interface: Ethernet Connection: Connector, M12, Axial, Male, D-coded, 4-pin

Services

	Part no.	Designation	Article	Description
	S981001	CS10-S-110	Start-up support	Details: Performed at location of customer's choosing, duration: max. 10 hours. Conditions: Devices and connection cables are already mounted, price not including travel costs and, if applicable, accommodation expenses. Restrictions: No mechanical (mounting) and electrical (wiring) work performed, no changes (attachments, wiring, programming) to third-party components in the nearby environment.
	S981005	CS10-T-110	Product training	Details: Location and content to be agreed upon, duration: max. 10 hours. Conditions: Price not including travel costs and, if applicable, accommodation expenses. Restrictions: Travel costs and accommodation expenses charged separately and according to expenditure.

Note



A list with all available accessories can be found on the Leuze website in the Download tab of the article detailed page.