

Technical data sheet

Inductive switch

Part no.: 50109732

IS 218FM/4NO.5F-10E-S12

Contents

- Technical data
- Dimensioned drawings
- Electrical connection
- Diagrams
- Operation and display
- Part number code
- Notes
- Accessories



Figure can vary



Technical data

Basic data

| | |
|----------------------------------|------------------------|
| Series | 218 |
| Application | Food & beverage design |
| Typ. operating range limit S_n | 10 mm |
| Operating range S_a | 0 ... 8.1 mm |

Special version

| | |
|-----------------|--------------------|
| Special version | Reduction factor 1 |
|-----------------|--------------------|

Characteristic parameters

| | |
|------|-----------|
| MTTF | 480 years |
|------|-----------|

Electrical data

| | |
|--------------------|------------------------------|
| Protective circuit | Inductive protection |
| | Polarity reversal protection |
| | Short circuit protected |

Performance data

| | |
|--|--|
| Supply voltage U_B | 10 ... 30 V, DC |
| Residual ripple | 0 ... 20 %, From U_B |
| Open-circuit current | 0 ... 10 mA |
| Temperature drift, max. (in % of S_p) | 10 %, Over the entire operating temperature range |
| Repeatability, max. (in % of S_p) | 5 %, For $U_B = 20 \dots 30$ VDC, ambient temperature $T_a = 23^\circ\text{C} \pm 5^\circ\text{C}$ |
| Switching hysteresis | 15 % |

Outputs

| | |
|-------------------------------------|------------|
| Number of digital switching outputs | 1 Piece(s) |
|-------------------------------------|------------|

Switching outputs

| | |
|-------------------------|------------|
| Voltage type | DC |
| Switching current, max. | 200 mA |
| Residual current, max. | 0.1 mA |
| Voltage drop | ≤ 2 V |

Switching output 1

| | |
|---------------------|--------------------|
| Switching element | Transistor, PNP |
| Switching principle | NO (normally open) |

Time behavior

| | |
|---------------------|--------|
| Switching frequency | 300 Hz |
| Readiness delay | 15 ms |

Connection

| | |
|-----------------------|------------|
| Number of connections | 1 Piece(s) |
|-----------------------|------------|

Connection 1

| | |
|--------------------|-----------------|
| Function | Signal OUT |
| | Voltage supply |
| Type of connection | Connector |
| Thread size | M12 |
| Type | Male |
| Material | Stainless steel |
| No. of pins | 4 -pin |
| Encoding | A-coded |

Mechanical data

| | |
|--------------------------------|---------------------------------|
| Design | Cylindrical |
| Thread size | M18 x 1 mm |
| Dimension (\varnothing x L) | 18 mm x 63.5 mm |
| Type of installation | Embedded |
| Housing material | Stainless steel |
| Stainless steel housing | AISI 316L |
| Sensing face material | Stainless steel, AISI 316L |
| Net weight | 51 g |
| Housing color | Silver |
| Type of fastening | Mounting thread |
| Standard measuring plate | 30 x 30 mm ² , Fe360 |

Operation and display

| | |
|-----------------|------------|
| Type of display | LED |
| Number of LEDs | 1 Piece(s) |

Environmental data

| | |
|--------------------------------|---------------|
| Ambient temperature, operation | -25 ... 85 °C |
| Ambient temperature, storage | -25 ... 85 °C |

Certifications

| | |
|--|---------------|
| Degree of protection | IP 68 |
| | IP 69K |
| Protection class | II |
| Certifications | c UL US |
| Test procedure for EMC in accordance with standard | IEC 61000-4-2 |
| | IEC 61000-4-3 |
| | IEC 61000-4-4 |
| Standards applied | IEC 60947-5-2 |

Correction factors

| | |
|-----------------|------|
| Aluminum | 1 |
| Stainless steel | 0.9 |
| Copper | 0.85 |
| Brass | 1.25 |
| Fe360 steel | 1 |

Classification

| | |
|-----------------------|----------|
| Customs tariff number | 85365019 |
| ECLASS 5.1.4 | 27270101 |
| ECLASS 8.0 | 27270101 |
| ECLASS 9.0 | 27270101 |
| ECLASS 10.0 | 27270101 |
| ECLASS 11.0 | 27270101 |
| ECLASS 12.0 | 27274001 |
| ECLASS 13.0 | 27274001 |
| ETIM 5.0 | EC002714 |
| ETIM 6.0 | EC002714 |
| ETIM 7.0 | EC002714 |
| ETIM 8.0 | EC002714 |

Dimensioned drawings

All dimensions in millimeters

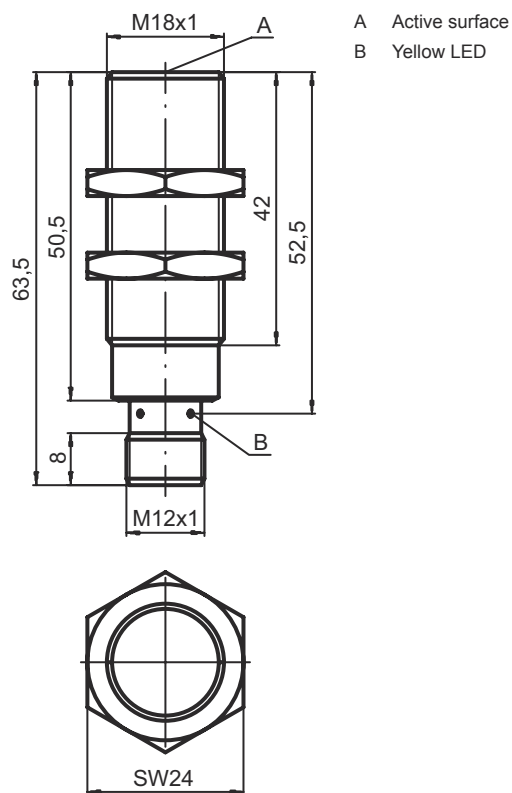

Electrical connection

Connection 1

| | |
|--------------------|-----------------|
| Function | Signal OUT |
| | Voltage supply |
| Type of connection | Connector |
| Thread size | M12 |
| Type | Male |
| Material | Stainless steel |
| No. of pins | 4 -pin |
| Encoding | A-coded |

| Pin | Pin assignment |
|-----|----------------|
| 1 | V+ |
| 2 | n.c. |
| 3 | GND |
| 4 | OUT 1 |

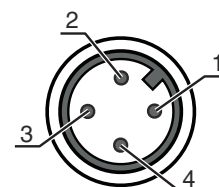

Diagrams

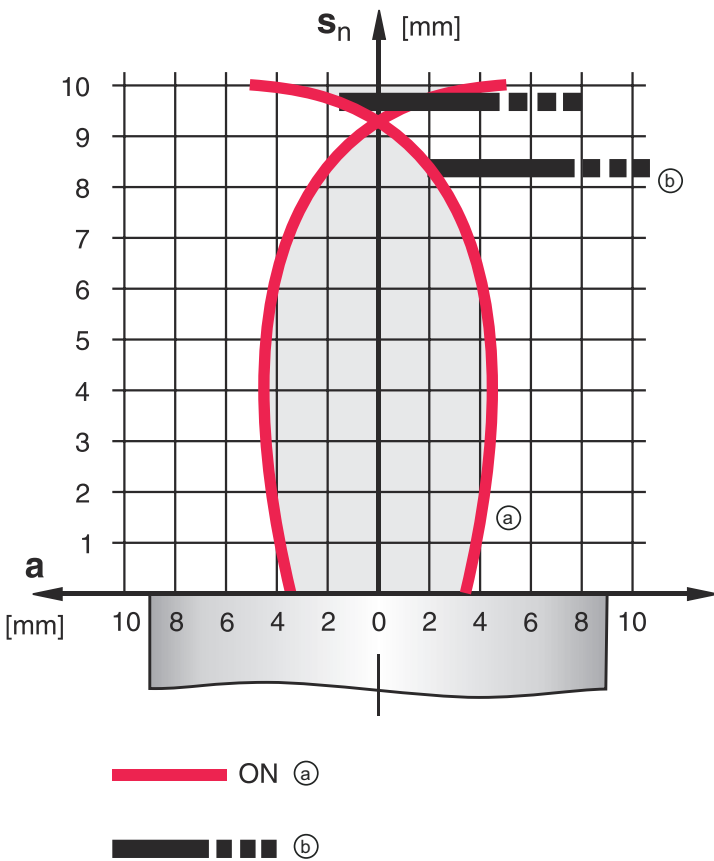
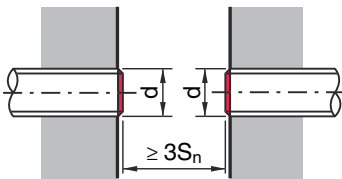
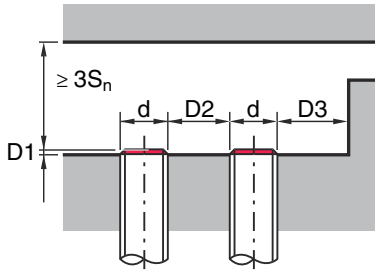

Operation and display

| LED | Display | Meaning |
|-----|--------------------------|----------------------------------|
| 1 | Yellow, continuous light | Switching output/switching state |

Part number code

Part designation: **ISX YYY ZZ/AAA.BB-CCC-DDD-DDD**

| | |
|------------|--|
| ISX | Operating principle / construction IS: inductive switch, standard design ISS: inductive switch, short construction |
| YYY | Series 203: series with Ø 3 mm 204: series with Ø 4 mm 205: series with M5 x 0.5 external thread 206: series with Ø 6.5 mm 208: series with M8 x 1 external thread 212: series with M12 x 1 external thread 218: series with M18 x 1 external thread 230: series with M30 x 1.5 external thread 240: series in cubic design 244: series in cubic design 255: series with 5 x 5 mm ² cross section 288: series with 8 x 8 mm ² cross section |
| ZZ | Housing / thread MM: metal housing (active surface: plastic) / metric thread FM: Full-metal housing (active surface: stainless steel AISI 316L) / metric thread MP: metal housing (active surface: plastic) / smooth (without thread) |
| AAA | Output current / supply 4NO: PNP transistor, NO contact 4NC: PNP transistor, NC contact 2NO: NPN transistor, NO contact 2NC: NPN transistor, NC contact 1NO: relay, NO contact / AC/DC 1NC: Relay, NC contact / AC/DC 44: 2 PNP transistor switching outputs, antivalent (NO + NC) 22: 2 NPN transistor switching outputs, antivalent (NO + NC) |
| BB | Special equipment n/a: no special equipment 5F: Food version 5: housing material V2A (1.4305, AISI 303) |
| CCC | Measurement range / type of installation 1E0: typ. range limit 1.0 mm / embedded installation 1E5: typ. range limit 1.5 mm / embedded installation 2E0: typ. range limit 2.0 mm / embedded installation 3E0: typ. range limit 3.0 mm / embedded installation 4E0: typ. range limit 4.0 mm / embedded installation 5E0: typ. range limit 5.0 mm / embedded installation 6E0: typ. range limit 6.0 mm / embedded installation 8E0: typ. range limit 8.0 mm / embedded installation 10E: typ. range limit 10.0 mm / embedded installation 12E: typ. range limit 12.0 mm / embedded installation 15E: typ. range limit 15.0 mm / embedded installation 20E: typ. range limit 20.0 mm / embedded installation 22E: typ. range limit 22.0 mm / embedded installation 2N5: typ. range limit 2.5 mm / non-embedded installation 4N0: typ. range limit 4.0 mm / non-embedded installation 8N0: typ. range limit 8.0 mm / non-embedded installation 10N: typ. range limit 10.0 mm / non-embedded installation 12N: typ. range limit 12.0 mm / non-embedded installation 14N: typ. range limit 14.0 mm / non-embedded installation 15N: typ. range limit 15.0 mm / non-embedded installation 20N: typ. range limit 20.0 mm / non-embedded installation 22N: typ. range limit 22.0 mm / non-embedded installation 25N: typ. range limit 25.0 mm / non-embedded installation 40N: typ. range limit 40.0 mm / non-embedded installation |
| DDD | Electrical connection n/a: cable, standard length 2000 mm S12: M12 connector, 4-pin, axial 200-S12: cable, length 200 mm with M12 connector, 4-pin, axial 200-S8.3: cable, length 200 mm with M8 connector, 3-pin, axial S8.3: M8 connector, 3-pin, axial 005-S8.3: cable, length 500 mm with M8 connector, 3-pin, axial 050: cable, standard length 5000 mm, 3-wire |

Note



A list with all available device types can be found on the Leuze website at www.leuze.com.

Notes

⚠ Observe intended use!

This product is not a safety sensor and is not intended as personnel protection.
 ⚠ The product may only be put into operation by competent persons.
 ⚠ Only use the product in accordance with its intended use.

⚠ For UL applications:

For UL applications, use is only permitted in Class 2 circuits in accordance with the NEC (National Electric Code).

Accessories

Connection technology - Connection cables

| | Part no. | Designation | Article | Description |
|--|----------|--------------------|------------------|--|
| | 50130654 | KD U-M12-4A-P1-020 | Connection cable | Connection 1: Connector, M12, Axial, Female, A-coded, 4 -pin Connector, LED: No Connection 2: Open end Shielded: No Cable length: 2.000 mm Sheathing material: PUR |
| | 50130657 | KD U-M12-4A-P1-050 | Connection cable | Connection 1: Connector, M12, Axial, Female, A-coded, 4 -pin Connector, LED: No Connection 2: Open end Shielded: No Cable length: 5.000 mm Sheathing material: PUR |
| | 50130648 | KD U-M12-4A-V1-020 | Connection cable | Connection 1: Connector, M12, Axial, Female, A-coded, 4 -pin Connector, LED: No Connection 2: Open end Shielded: No Cable length: 2.000 mm Sheathing material: PVC |
| | 50130688 | KD U-M12-4W-V1-020 | Connection cable | Connection 1: Connector, M12, Angled, Female, A-coded, 4 -pin Connector, LED: No Connection 2: Open end Shielded: No Cable length: 2.000 mm Sheathing material: PVC |

Accessories

Mounting technology - Other

| | Part no. | Designation | Article | Description |
|--|----------|-------------|---------|---|
|  | 50111501 | MC 018K | Clamp | Diameter, inner: 18 mm Design of mounting device: Mounting clamp Fastening, at system: Through-hole mounting Mounting bracket, at device: Clampable Type of mounting device: Rigid Material: Plastic |

| Note | |
|--|---|
|  | A list with all available accessories can be found on the Leuze website in the Download tab of the article detailed page. |