

## Technical data sheet

### Inductive switch

Part no.: 50109734

IS 218FM/4NO.5F-20N-S12

#### Contents

- Technical data
- Dimensioned drawings
- Electrical connection
- Diagrams
- Operation and display
- Part number code
- Notes
- Accessories



Figure can vary



## Technical data

### Basic data

Series	218
Application	Food & beverage design
Typ. operating range limit $S_n$	20 mm
Operating range $S_a$	0 ... 16.2 mm

### Special version

Special version	Reduction factor 1
-----------------	--------------------

### Characteristic parameters

MTTF	480 years
------	-----------

### Electrical data

Protective circuit	Inductive protection
	Polarity reversal protection
	Short circuit protected

### Performance data

Supply voltage $U_B$	10 ... 30 V, DC
Residual ripple	0 ... 20 %, From $U_B$
Open-circuit current	0 ... 10 mA
Temperature drift, max. (in % of $S_p$ )	10 %, Over the entire operating temperature range
Repeatability, max. (in % of $S_p$ )	5 %, For $U_B = 20 \dots 30$ VDC, ambient temperature $T_a = 23^\circ\text{C} \pm 5^\circ\text{C}$
Switching hysteresis	15 %

### Outputs

Number of digital switching outputs	1 Piece(s)
-------------------------------------	------------

### Switching outputs

Voltage type	DC
Switching current, max.	200 mA
Residual current, max.	0.1 mA
Voltage drop	$\leq 2$ V

### Switching output 1

Switching element	Transistor, PNP
Switching principle	NO (normally open)

### Time behavior

Switching frequency	200 Hz
Readiness delay	15 ms

### Connection

Number of connections	1 Piece(s)
-----------------------	------------

### Connection 1

Function	Signal OUT
	Voltage supply
Type of connection	Connector
Thread size	M12
Type	Male
Material	Stainless steel
No. of pins	4 -pin
Encoding	A-coded

### Mechanical data

Design	Cylindrical
Thread size	M18 x 1 mm
Dimension ( $\varnothing$ x L)	18 mm x 63.5 mm
Type of installation	Non-embedded
Housing material	Stainless steel
Stainless steel housing	AISI 316L
Sensing face material	Stainless steel, AISI 316L
Net weight	51 g
Housing color	Silver
Type of fastening	Mounting thread
Standard measuring plate	60 x 60 mm <sup>2</sup> , Fe360

### Operation and display

Type of display	LED
Number of LEDs	1 Piece(s)

### Environmental data

Ambient temperature, operation	-25 ... 85 °C
Ambient temperature, storage	-25 ... 85 °C

### Certifications

Degree of protection	IP 68
	IP 69K
Protection class	II
Certifications	c UL US
Test procedure for EMC in accordance with standard	IEC 61000-4-2
	IEC 61000-4-3
	IEC 61000-4-4
Standards applied	IEC 60947-5-2

### Correction factors

Aluminum	1
Stainless steel	0.6
Copper	0.9
Brass	1.35
Fe360 steel	1

### Classification

Customs tariff number	85365019
ECLASS 5.1.4	27270101
ECLASS 8.0	27270101
ECLASS 9.0	27270101
ECLASS 10.0	27270101
ECLASS 11.0	27270101
ECLASS 12.0	27274001
ECLASS 13.0	27274001
ETIM 5.0	EC002714
ETIM 6.0	EC002714
ETIM 7.0	EC002714
ETIM 8.0	EC002714

# Dimensioned drawings

All dimensions in millimeters

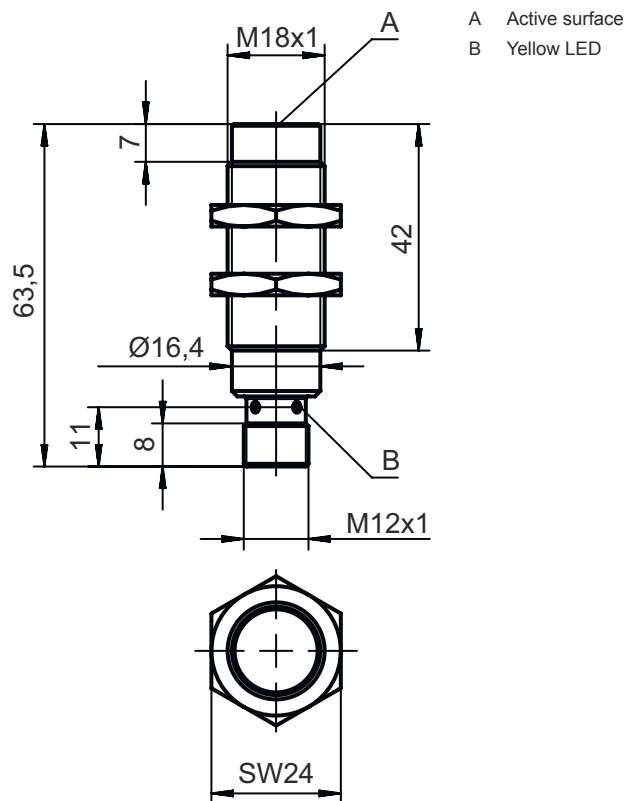

## Electrical connection

### Connection 1

Function	Signal OUT
	Voltage supply
Type of connection	Connector
Thread size	M12
Type	Male
Material	Stainless steel
No. of pins	4 -pin
Encoding	A-coded

### Pin Pin assignment

Pin	Pin assignment
1	V+
2	n.c.
3	GND
4	OUT 1

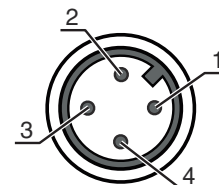

# Diagrams

## Non-embedded installation

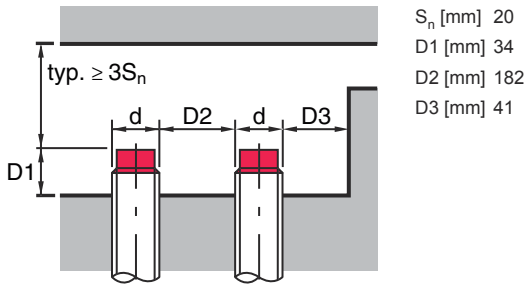

## Types with $S_n = 20.0$ mm

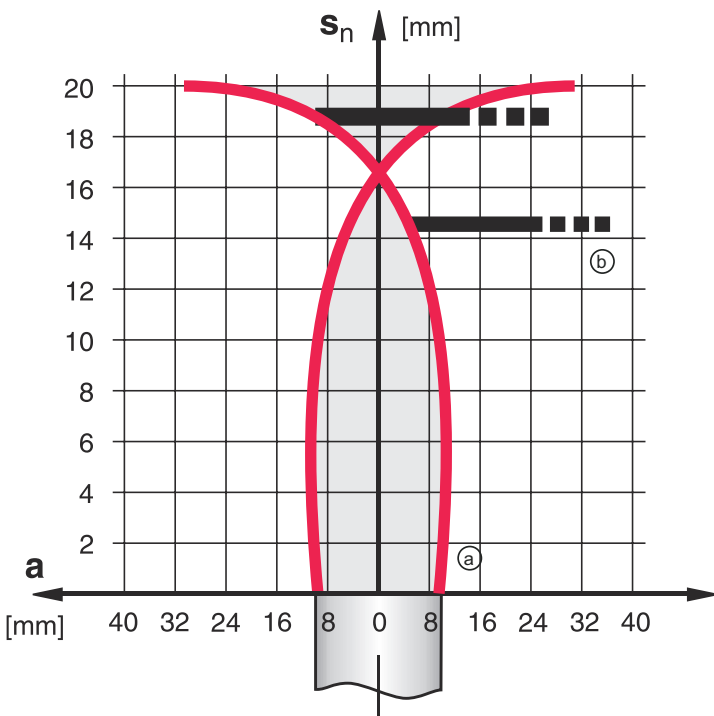

- a Inductive switch
- b Standard measuring plate

— ON (a)

■ ■ ■ ■ (b)

## Operation and display

LED	Display	Meaning
1	Yellow, continuous light	Switching output/switching state

# Part number code

Part designation: **ISX YYY ZZ/AAA.BB-CCC-DDD-DDD**

<b>ISX</b>	<b>Operating principle / construction</b> IS: inductive switch, standard design ISS: inductive switch, short construction
<b>YYY</b>	<b>Series</b> 203: series with Ø 3 mm 204: series with Ø 4 mm 205: series with M5 x 0.5 external thread 206: series with Ø 6.5 mm 208: series with M8 x 1 external thread 212: series with M12 x 1 external thread 218: series with M18 x 1 external thread 230: series with M30 x 1.5 external thread 240: series in cubic design 244: series in cubic design 255: series with 5 x 5 mm <sup>2</sup> cross section 288: series with 8 x 8 mm <sup>2</sup> cross section
<b>ZZ</b>	<b>Housing / thread</b> MM: metal housing (active surface: plastic) / metric thread FM: Full-metal housing (active surface: stainless steel AISI 316L) / metric thread MP: metal housing (active surface: plastic) / smooth (without thread)
<b>AAA</b>	<b>Output current / supply</b> 4NO: PNP transistor, NO contact 4NC: PNP transistor, NC contact 2NO: NPN transistor, NO contact 2NC: NPN transistor, NC contact 1NO: relay, NO contact / AC/DC 1NC: Relay, NC contact / AC/DC 44: 2 PNP transistor switching outputs, antivalent (NO + NC) 22: 2 NPN transistor switching outputs, antivalent (NO + NC)
<b>BB</b>	<b>Special equipment</b> n/a: no special equipment 5F: Food version 5: housing material V2A (1.4305, AISI 303)
<b>CCC</b>	<b>Measurement range / type of installation</b> 1E0: typ. range limit 1.0 mm / embedded installation 1E5: typ. range limit 1.5 mm / embedded installation 2E0: typ. range limit 2.0 mm / embedded installation 3E0: typ. range limit 3.0 mm / embedded installation 4E0: typ. range limit 4.0 mm / embedded installation 5E0: typ. range limit 5.0 mm / embedded installation 6E0: typ. range limit 6.0 mm / embedded installation 8E0: typ. range limit 8.0 mm / embedded installation 10E: typ. range limit 10.0 mm / embedded installation 12E: typ. range limit 12.0 mm / embedded installation 15E: typ. range limit 15.0 mm / embedded installation 20E: typ. range limit 20.0 mm / embedded installation 22E: typ. range limit 22.0 mm / embedded installation 2N5: typ. range limit 2.5 mm / non-embedded installation 4N0: typ. range limit 4.0 mm / non-embedded installation 8N0: typ. range limit 8.0 mm / non-embedded installation 10N: typ. range limit 10.0 mm / non-embedded installation 12N: typ. range limit 12.0 mm / non-embedded installation 14N: typ. range limit 14.0 mm / non-embedded installation 15N: typ. range limit 15.0 mm / non-embedded installation 20N: typ. range limit 20.0 mm / non-embedded installation 22N: typ. range limit 22.0 mm / non-embedded installation 25N: typ. range limit 25.0 mm / non-embedded installation 40N: typ. range limit 40.0 mm / non-embedded installation
<b>DDD</b>	<b>Electrical connection</b> n/a: cable, standard length 2000 mm S12: M12 connector, 4-pin, axial 200-S12: cable, length 200 mm with M12 connector, 4-pin, axial 200-S8.3: cable, length 200 mm with M8 connector, 3-pin, axial S8.3: M8 connector, 3-pin, axial 005-S8.3: cable, length 500 mm with M8 connector, 3-pin, axial 050: cable, standard length 5000 mm, 3-wire

**Note**

 A list with all available device types can be found on the Leuze website at [www.leuze.com](http://www.leuze.com).

# Notes

**⚠ Observe intended use!**

This product is not a safety sensor and is not intended as personnel protection.  
 ⚠ The product may only be put into operation by competent persons.  
 ⚠ Only use the product in accordance with its intended use.

**⚠ For UL applications:**

For UL applications, use is only permitted in Class 2 circuits in accordance with the NEC (National Electric Code).

## Accessories

### Connection technology - Connection cables

	Part no.	Designation	Article	Description
	50130654	KD U-M12-4A-P1-020	Connection cable	Connection 1: Connector, M12, Axial, Female, A-coded, 4 -pin Connector, LED: No Connection 2: Open end Shielded: No Cable length: 2.000 mm Sheathing material: PUR
	50130657	KD U-M12-4A-P1-050	Connection cable	Connection 1: Connector, M12, Axial, Female, A-coded, 4 -pin Connector, LED: No Connection 2: Open end Shielded: No Cable length: 5.000 mm Sheathing material: PUR
	50130648	KD U-M12-4A-V1-020	Connection cable	Connection 1: Connector, M12, Axial, Female, A-coded, 4 -pin Connector, LED: No Connection 2: Open end Shielded: No Cable length: 2.000 mm Sheathing material: PVC
	50130688	KD U-M12-4W-V1-020	Connection cable	Connection 1: Connector, M12, Angled, Female, A-coded, 4 -pin Connector, LED: No Connection 2: Open end Shielded: No Cable length: 2.000 mm Sheathing material: PVC

**Accessories**

Mounting technology - Other

	Part no.	Designation	Article	Description
	50111501	MC 018K	Clamp	Diameter, inner: 18 mm Design of mounting device: Mounting clamp Fastening, at system: Through-hole mounting Mounting bracket, at device: Clampable Type of mounting device: Rigid Material: Plastic

Note	
	A list with all available accessories can be found on the Leuze website in the Download tab of the article detailed page.