

## Technical data sheet

### Throughbeam photoelectric sensor receiver

Part no.: 50144559

LE318B/4P-200-M12

#### Contents

- Technical data
- Dimensioned drawings
- Electrical connection
- Diagrams
- Operation and display
- Suitable transmitters
- Part number code
- Notes
- Further information
- Accessories



Figure can vary



## Technical data

### Basic data

Series	318B
Operating principle	Throughbeam principle
Device type	Receiver

### Optical data

Operating range	Guaranteed operating range
Operating range	0 ... 10 m
Operating range limit	Typical operating range
Operating range limit	0 ... 15 m

### Electrical data

Protective circuit	Polarity reversal protection Short circuit protected
--------------------	---

### Performance data

Supply voltage $U_B$	10 ... 30 V, DC, Incl. residual ripple
Residual ripple	0 ... 15 %, From $U_B$
Open-circuit current	0 ... 15 mA

### Outputs

Number of digital switching outputs	2 Piece(s)
-------------------------------------	------------

### Switching outputs

Voltage type	DC
Switching current, max.	100 mA
Switching voltage	high: $\geq(U_B - 2V)$ low: $\leq 2 V$

### Switching output 1

Assignment	Connection 1, pin 4
Switching element	Transistor, PNP
Switching principle	Light switching

### Switching output 2

Assignment	Connection 1, pin 2
Switching element	Transistor, PNP
Switching principle	Dark switching

### Time behavior

Switching frequency	500 Hz
Response time	1 ms
Readiness delay	300 ms

### Connection

#### Connection 1

Function	Signal OUT Voltage supply
Type of connection	Cable with connector
Cable length	200 mm
Sheathing material	PUR
Cable color	Black
Number of conductors	4 -wire
Wire cross section	0.2 mm <sup>2</sup>
Thread size	M12
Type	Male
Material	Plastic
No. of pins	4 -pin
Encoding	A-coded

### Mechanical data

Thread size	M18 x 1 mm
Dimension ( $\varnothing$ x L)	18 mm x 46 mm
Housing material	Plastic
Plastic housing	ABS
Lens cover material	Plastic
Net weight	20 g
Housing color	Black Red

### Operation and display

Type of display	LED
Number of LEDs	1 Piece(s)

### Environmental data

Ambient temperature, operation	-40 ... 60 °C
Ambient temperature, storage	-40 ... 70 °C

### Certifications

Degree of protection	IP 67
Protection class	III
Certifications	c UL US
Standards applied	IEC 60947-5-2

### Classification

Customs tariff number	85365019
ECLASS 5.1.4	27270901
ECLASS 8.0	27270901
ECLASS 9.0	27270901
ECLASS 10.0	27270901
ECLASS 11.0	27270901
ECLASS 12.0	27270901
ECLASS 13.0	27270901
ETIM 5.0	EC002716
ETIM 6.0	EC002716
ETIM 7.0	EC002716
ETIM 8.0	EC002716

# Dimensioned drawings

All dimensions in millimeters

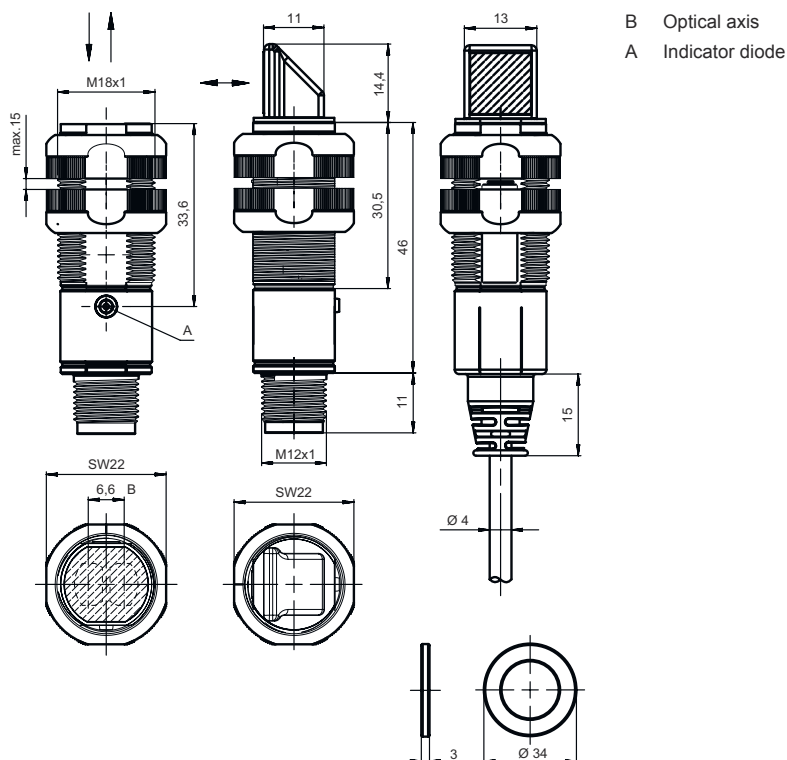

## Electrical connection

### Connection 1

Function	Signal OUT Voltage supply
Type of connection	Cable with connector
Cable length	200 mm
Sheathing material	PUR
Cable color	Black
Number of conductors	4 -wire
Wire cross section	0.2 mm <sup>2</sup>
Thread size	M12
Type	Male
Material	Plastic
No. of pins	4 -pin
Encoding	A-coded

### Pin Pin assignment

Pin	Pin assignment
1	V+
2	OUT 2
3	GND
4	OUT 1

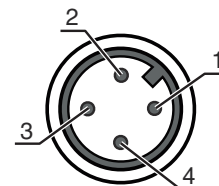

# Diagrams

## Typ. response behavior

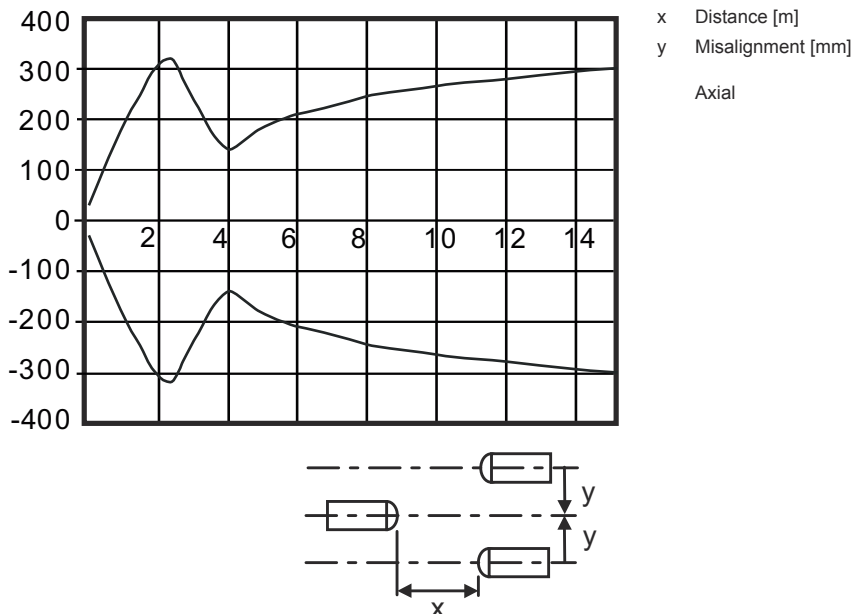

## Operation and display

LED	Display	Meaning
1	Green, continuous light	Operational readiness
	Yellow, continuous light	Light path free
	Yellow, flashing	No function reserve

## Suitable transmitters

Part no.	Designation	Article	Description
50144558	LS318BI/9D-200-M12	Throughbeam photoelectric sensor transmitter	Special version: Deactivation input Operating range limit: 0 ... 23 m Light source: LED, Infrared Supply voltage: DC Deactivation inputs: 2 Piece(s) Connection: Cable with connector, 200 mm, M12, Plastic, 4 -wire, 4 -pin

## Part number code

Part designation: **XXX318BY-AAAF.BB/CC-DDD**

<b>XXX318B</b>	<b>Operating principle</b> PRK: Retro-reflective photoelectric sensor with polarization filter ET: energetic diffuse reflection sensor FT: diffuse reflection sensor with fading LE: Throughbeam photoelectric sensor receiver LS: throughbeam photoelectric sensor transmitter
<b>Y</b>	<b>Light type</b> n/a: red light I: infrared light
<b>AAAF</b>	<b>Preset range (optional)</b> n/a: operating range acc. to data sheet xxxF: Preset range [mm]



## Part number code

<b>BB</b>	<b>Equipment</b> n/a: axial optics W: 90° angular optics 3: teach-in via button X: reinforced fading
<b>CC</b>	<b>Switching output / function (OUT1 = pin 4, OUT2 = pin 2):</b> 4: PNP transistor output, light switching P: PNP transistor output, dark switching 2: NPN transistor output, light switching N: NPN transistor output, dark switching 9: input for transmitter deactivation (deactivation with HIGH signal) D: Input for transmitter deactivation (deactivation with LOW signal) X: pin not used
<b>DDD</b>	<b>Electrical connection</b> n/a: cable, standard length 2000 mm, 4-wire M12: M12 connector, 4-pin (plug) 5000: cable, standard length 5000 mm, 4-wire 200-M12: cable, length 200 mm with M12 connector, 4-pin, axial (plug)

### Note

	<ul style="list-style-type: none"> <li>A list with all available device types can be found on the Leuze website at <a href="http://www.leuze.com">www.leuze.com</a>.</li> </ul>
--	---

## Notes

 <b>Observe intended use!</b>	
	<ul style="list-style-type: none"> <li>This product is not a safety sensor and is not intended as personnel protection.</li> <li>The product may only be put into operation by competent persons.</li> <li>Only use the product in accordance with its intended use.</li> </ul>

### For UL applications:

	<ul style="list-style-type: none"> <li>For UL applications, use is only permitted in Class 2 circuits in accordance with the NEC (National Electric Code).</li> <li>These proximity switches shall be used with UL Listed Cable assemblies rated 30V, 0.5A min, in the field installation, or equivalent (categories: CYJV/ CYJV7 or PVVA/PVVA7)</li> </ul>
--	---

## Further information

- Sum of the output currents for both outputs, 50 mA for ambient temperatures > 40 °C

## Accessories

### Connection technology - Connection cables

	Part no.	Designation	Article	Description
	50130652	KD U-M12-4A-V1-050	Connection cable	Connection 1: Connector, M12, Axial, Female, A-coded, 4 -pin Connector, LED: No Connection 2: Open end Shielded: No Cable length: 5.000 mm Sheathing material: PVC
	50130690	KD U-M12-4W-V1-050	Connection cable	Connection 1: Connector, M12, Angled, Female, A-coded, 4 -pin Connector, LED: No Connection 2: Open end Shielded: No Cable length: 5.000 mm Sheathing material: PVC



### Mounting technology - Mounting brackets

	Part no.	Designation	Article	Description
	50113548	BT D18M.5	Mounting bracket	Diameter, inner: 18 mm Design of mounting device: Angle, L-shape Fastening, at system: Through-hole mounting Mounting bracket, at device: Screw type Type of mounting device: Rigid Material: Stainless steel

### Mounting technology - Rod mounts

	Part no.	Designation	Article	Description
	50117490	BTU D18M-D12	Mounting system	Design of mounting device: Mounting system Fastening, at system: Through-hole mounting Mounting bracket, at device: Screw type Type of mounting device: Clampable, Adjustable, Turning, 360° Material: Metal

### Mounting technology - Other

	Part no.	Designation	Article	Description
	50117258	BT 318P-LS	Fastening	Design of mounting device: Mounting clamp Fastening, at system: Through-hole mounting Mounting bracket, at device: Clampable Type of mounting device: Rigid Material: Plastic Shock absorber: No
	50121904 **	BT318B-OM	Fastening	Design of mounting device: Mounting clamp Fastening, at system: Through-hole mounting Mounting bracket, at device: Screw type Type of mounting device: Swiveling, Adjustable, Turning Material: Plastic Shock absorber: No

\*\* Included in delivery contents

## Accessories

### Note



🔗 A list with all available accessories can be found on the Leuze website in the Download tab of the article detailed page.