

LPS 36 HI

Light section sensor for object measurement

en 04-2014/06 50118357-03

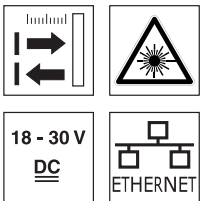

200 ... 600mm

- Light section sensor for object measurement
- Calibrated system
- Measurement range x-axis: 46 ... 140mm
- Measurement range z-axis: 200 ... 600mm
- Measurement time: 10ms
- Measurement data transfer via Fast Ethernet
- Measurement value display in mm on OLED display as an alignment aid
- Incremental transmitter input
- Up to 240 value pairs (x,z) along the laser line
- Up to 16 inspection tasks
- Activation input, trigger input, operational readiness output, cascading output

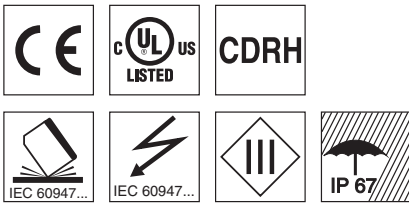

Accessories:

(available separately)

- Mounting systems BT 56, BT 59
- Cable with M12 connector (K-D ...)
- Configuration memory K-DS M12A-8P-0,75m-LxS36-CP

Dimensioned drawing

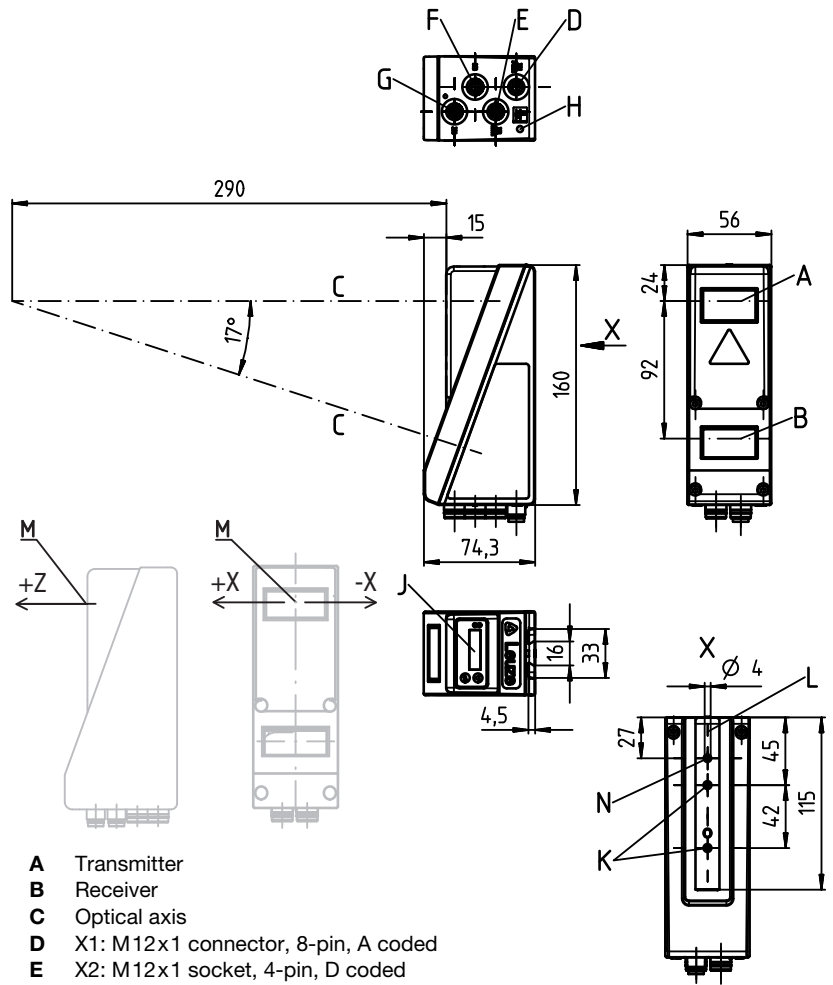

- A** Transmitter
- B** Receiver
- C** Optical axis
- D** X1: M12x1 connector, 8-pin, A coded
- E** X2: M12x1 socket, 4-pin, D coded
- F** X3: M12x1 socket, 8-pin, A coded (LPS 36/EN only)
- G** X4: not used (dummy plug)
- H** PE screw
- J** OLED display and key pad
- K** M4 thread, 4,5 deep
- L** Holder for mounting system BT 56 / BT 59
- M** Zero point and orientation of the coordinate system for measurement data
- N** 4mm bore hole in transmitter axis

Measurement range, typical

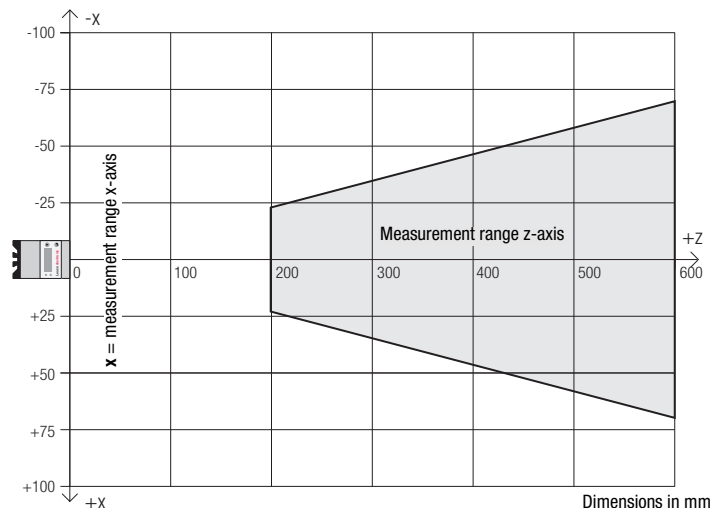

We reserve the right to make changes • DS_LPS36HI_en_50118357_03.fm

Specifications

Optical data

Measurement range ¹⁾	x-axis	46 ... 140mm
	z-axis	200 ... 600mm
Light source		laser
Wavelength		658nm (visible red light)
Max. output power		< 8mW
Pulse duration		< 3ms
Exposure time		60 ... 1300µs
Laser line		approx. 170x1.5mm at 600mm

Error limits (relative to measurement distance)

Geometric resolution ²⁾	x-axis	0.2 ... 0.6mm
	z-axis	0.1 ... 0.9mm
Linearity z-axis ³⁾		≤ ±0.5%
Repeatability z-axis ³⁾		≤ ±0.25%
B/w detect. thresholds (6 ... 90% rem.)		≤ ±0.5%

Timing

Measurement time	10ms
Delay before start-up	approx. 1.5s

Electrical data

Operating voltage U _B ⁴⁾	18 ... 30VDC (incl. residual ripple)
Residual ripple	≤ 15% of U _B
Open-circuit current	≤ 200mA
Ethernet interface	UDP
Switching outputs	1 (ready) / 100mA / push-pull ⁵⁾ on X1 1 (cascading) / 100mA / push-pull ⁵⁾ on X1
Inputs	1 (trigger) on X1 1 (activation) on X1
Signal voltage high/low	≥ (U _B -2V) / ≤ 2V

Indicators

Green LED	continuous light	ready
	off	no voltage
Yellow LED	continuous light	Ethernet connection available
	flashing	Ethernet data transmission active
	off	no Ethernet connection available

Mechanical data

Housing	aluminum frame with plastic cover
Optics cover	glass
Weight	620g
Connection type	M12 connector

Environmental data

Ambient temp. (operation/storage)	-30°C ... +50°C / -30°C ... +70°C
Protective circuit ⁶⁾	1, 2, 3
VDE safety class	III, protective extra-low voltage
Protection class	IP 67
Laser class	2M (according to EN 60825-1 and 21 CFR 1040.10 with Laser Notice No. 50)
Standards applied	IEC/EN 60947-5-2
Certifications	UL 508, C22.2 No.14-13 ⁴⁾ ⁷⁾

- 1) Luminosity coefficient 6% ... 90%
- 2) Minimum and maximum value dependent on the measurement distance, at 20°C after 30min. warmup time, average range U_B, z resolution at factory setting median "3"
- 3) Reflectivity 90%, identical object, identical environment conditions, measurement object ≥ 20mmx20mm
- 4) For UL applications: for use in class 2 circuits according to NEC only
- 5) The push-pull switching outputs must not be connected in parallel
- 6) 1=transient protection, 2=polarity reversal protection, 3=short circuit protection for all outputs
- 7) These sensors shall be used with UL Listed Cable assemblies rated 30V, 0.5A min, in the field installation, or equivalent (categories: CYJV/CYJV7 or PVVA/PVVA7)

Interface assignments

X1 - logic and power		
Pin No.	Signal	Color
1	+24VDC	WH
2	InAct (activation)	BN
3	GND	GN
4	OutReady (ready)	YE
5	InTrig (trigger)	GY
6	OutCas (cascading)	PK
7	Do not connect	BU
8	Do not connect	RD

8-pin M12 plug, A coded

X2 - Ethernet		
Pin No.	Signal	Color
1	Tx+	YE
2	Rx+	WH
3	Tx-	OR
4	Rx-	BU

4-pin M12 socket, D coded

X3 - encoder		
Pin No.	Signal	Color
1	Enc. +24VDC	WH
2	(GND)	BN
3	GND	GN
4	Enc. A+	YE
5	Enc. A-	GY
6	Enc. B+	PK
7	Enc. B-	BU
8	+5VDC Out	RD

8-pin M12 socket, A coded

Order guide

Line profile sensor

With encoder interface

Designation	Part no.
LPS 36HI/EN	50111334

LPS 36HI... - 04

Tables

LED	State	Display during measurement operation
green	continuous light	Sensor ready
	off	Sensor not ready
yellow	continuous light	Ethernet connection established
	flashing	Ethernet data transmission active
	off	No Ethernet connection

Diagrams

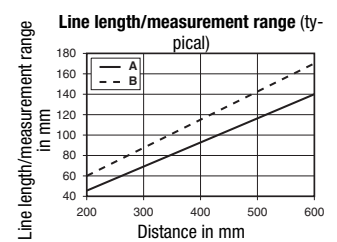

- A Measurement range
- B Line length

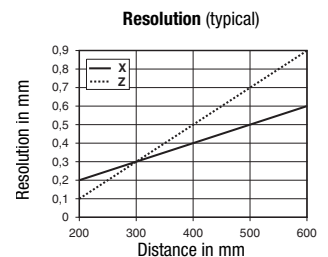

Remarks

Operate in accordance with intended use!

- ⚠ This product is not a safety sensor and is not intended as personnel protection.
- ⚠ The product may only be put into operation by competent persons.
- ⚠ Only use the product in accordance with the intended use.

● Warmup time:

After a warmup time of 30 min., the light section sensor has reached the operating temperature required for an optimum measurement.

● Encoder interface (LPS 36HI/EN):

24V single ended (A+, B+) or 5V differential (A+/A-, B+/B-) Current consumption max. 140mA, pulse frequency max. 300kHz.

Laser safety notices



ATTENTION, LASER RADIATION – LASER CLASS 2M

Never look directly into the beam or point the beam in the direction of telescope users!

The device fulfills the EN 60825-1:2008-05 (IEC 60825-1:2007) safety regulations for a product in **laser class 2M** as well as the U.S. 21 CFR 1040.10 regulations with deviations corresponding to "Laser Notice No. 50" from June 24th, 2007.

- ⚠ Never look directly into the laser beam or in the direction of reflecting laser beams!
If you look into the beam path over a longer time period, there is a risk of injury to the retina.
- ⚠ Do not point the laser beam of the device at persons!
- ⚠ Intercept the laser beam with an opaque, non-reflective object if the laser beam is accidentally directed towards a person.
- ⚠ When mounting and aligning the device, avoid reflections of the laser beam off reflective surfaces!
- ⚠ **CAUTION!** Use of controls or adjustments or performance of procedures other than specified herein may result in hazardous light exposure.
The use of optical instruments or devices (e.g., magnifying glasses, binoculars) with the product will increase eye hazard.
- ⚠ Adhere to the applicable legal and local regulations regarding protection from laser beams acc. to EN 60825 (IEC 60825) in its latest version.
- ⚠ The device must not be tampered with and must not be changed in any way.
There are no user-serviceable parts inside the device.
Repairs must only be performed by Leuze electronic GmbH + Co. KG.

NOTICE

Affix laser information and warning signs!

Laser information and warning signs are affixed to the device (see ①). In addition, self-adhesive laser information and warning signs (stick-on labels) are supplied in several languages (see ②).

- ⚠ Affix the laser information sheet with the language appropriate for the place of use to the device.
When using the device in the US, use the stick-on label with the "Complies with 21 CFR 1040.10" notice.
- ⚠ Affix the laser information and warning signs near the device if no signs are attached to the device (e.g. because the device is too small) or if the attached laser information and warning signs are concealed due to the installation position.
Affix the laser information and warning signs so that they are legible without exposing the reader to the laser radiation of the device or other optical radiation.

①

A Laser exit opening
B Laser warning sign
C Laser information sign with laser parameters

②

50111877-01

LASERSTRAHLUNG
NICHT IN DEN STRAHLEN BLICKEN
ODER DIREKT MIT OPTISCHEN
INSTRUMENTEN BETRACHTEN

Max. Leistung (peak): 8,7 mW
Impulsdauer: 3 ms
Wellenlänge: 658 nm

LASER-KLASSE 2M
DIN EN 60825-1:2008-05

RADIAZIONE LASER
NON FISSARE IL FASCIO AD OCCHIO
NUDO NE GUARDARE DIRETTAMENTE
CON STRUMENTI OTTICI

Potenza max. (peak): 8,7 mW
Durata dell'impulso: 3 ms
Lunghezza d'onda: 658 nm

APPARECCHIO LASER DI CLASSE 2M
EN 60825-1:2007

LASER RADIATION
DO NOT STARE INTO BEAM
OR VIEW DIRECTLY WITH
OPTICAL INSTRUMENTS

Maximum Output (peak): 8,7 mW
Pulse duration: 3 ms
Wavelength: 658 nm

CLASS 2M LASER PRODUCT
EN 60825-1:2007

RAYONNEMENT LASER
NE PAS REGARDER DANS LE FASCICU
NI A L'OEIL NI A L'AJDE D'UN
INSTRUMENT D'OPTIQUE

Puissance max. (crête): 8,7 mW
Durée d'impulsion: 3 ms
Longueur d'onde: 658 nm

APPAREIL A LASER DE CLASSE 2M
EN 60825-1:2007

AVOID EXPOSURE – LASER RADIATION
IS EMITTED FROM THIS APERTURE

EXPOSITION DANGEREUSE – UN RAYONNEMENT
LASER EST EMIS PAR CETTE OUVERTURE

RADIACION LASER
NO MIRAR FUENTE O HAZ
NI MIRAR DIRECTAMENTE CON
INSTRUMENTOS OPTICOS

Potencia máx. (peak): 8,7 mW
Duración del impulso: 3 ms
Longitud de onda: 658 nm

PRODUCTO LASER DE CLASE 2M
EN 60825-1:2007

RADIACÃO LASER
NÃO OLHAR FASCINHO O FEIXE
NEM OLHAR DIRETAMENTE
COM INSTRUMENTOS OPTICOS

Potência máx. (peak): 8,7 mW
Período de pulso: 3 ms
Comprimento de onda: 658 nm

EQUIPAMENTO LASER CLASSE 2M
EN 60825-1:2007

LASER RADIATION
DO NOT STARE INTO BEAM
OR VIEW DIRECTLY WITH
OPTICAL INSTRUMENTS

Maximum Output (peak): 8,7 mW
Pulse duration: 3 ms
Wavelength: 658 nm

CLASS 2M LASER PRODUCT
EN 60825-1:2007
Complies with 21 CFR 1040.10

激光辐射
勿直视或透过光学
仪器直接观察激光束

最大输出 (峰值): 8,7 mW
脉冲持续时间: 3 ms
波长: 658 nm

2M 类激光产品
GB7247.1-2012

Establish connection to PC

The LPS is configured via a PC using the **LPSsoft** program before it is integrated into the process control.

In order to be able to establish an UDP communication with the PC, the IP address of your PC and the IP address of the LPS must lie in the same address range. The LPS has no built-in DHCP client, so that you need to set the address manually. This is done the easiest way via the PC.



Notice!

If you are using a desktop firewall, please ensure that the control can communicate with the LPS via the Ethernet interface on ports 9008 and 5634 using UDP. Furthermore, the firewall must allow ICMP echo messages to pass through for the connection test (ping).

If the PC is usually connected to a network using DHCP address allocation, the easiest way to access the LPS is by applying an alternative configuration in the TCP/IP settings of the PC and connecting the LPS directly to the PC.

- ☞ Check the network address of the LPS by pressing the **↵** button on the key pad of the sensor during normal operation of the LPS twice in succession, then by pressing **▼** twice and followed by pressing the **↵** button again.

This will take you to the Ethernet submenu and enable you to read the current settings of the LPS consecutively when pressing **▼** repeatedly.

- ☞ Make a note of the values for IP-Address and Net. Mask Addr..

The value in Net. Mask Addr. specifies which digits of the IP address of the PC and LPS must match so that they can communicate with each other.

Address of the LPS	Net mask	Address of the PC
192.168.060.003	255.255.255.0	192.168.060.xxx
192.168.060.003	255.255.0.0	192.168.xxx.xxx

Instead of **xxx** you can now allocate any numbers between 000 and 255 to your PC, but NOT THE SAME numbers as contained in the address of the LPS.

For example 192.168.060.110 (but not 192.168.060.003!). If LPS and PC have the same IP address, they cannot communicate with each other.

Configuring the IP address for a PC

- ☞ Log in to your PC as an administrator.
- ☞ Using Start->System control go to the Network connections (Windows XP) menu or to the Network center and release center (Windows Vista) menu.
- ☞ There select the *LAN connection* and bring up the associated Features page by right clicking with the mouse.
- ☞ Select the Internet Protocol (TCP/IP) (by scrolling down, if necessary) and click on Properties.
- ☞ In the Internet Protocol (TCP/IP) Properties window select the Alternate configuration tab.
- ☞ Configure the IP address of the PC in the address range of the LPS.
Attention: do not use the same as for the LPS!
- ☞ Set the Subnet mask of the PC to the same value as the one for the LPS.
- ☞ Close the configuration dialog by confirming all windows using **OK**.
- ☞ *Connect the interface X2 of the LPS directly to the LAN port of your PC.* Use a KB ET-...-SA-RJ45 cable for the connection.

The PC will first try to establish a network connection via the automatic configuration. This will take a few seconds. Following that the alternative configuration, which you have just set up, is activated, and thus the PC can communicate with the LPS.

Information about configuring the LPS using **LPSsoft** software can be found in the Technical Description.

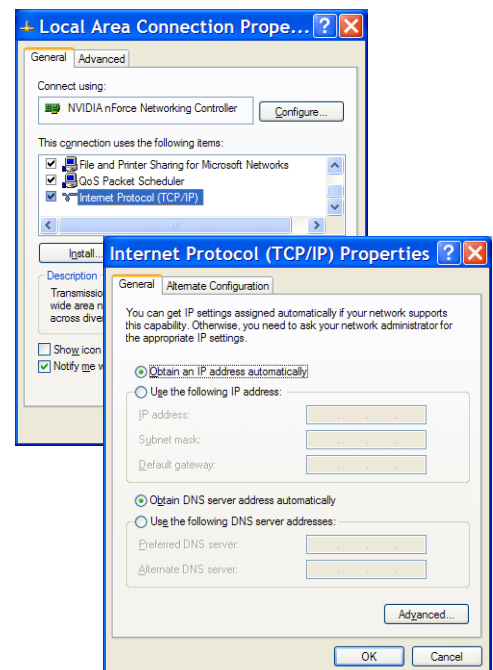

Commissioning

For the commissioning and integration of the sensor in the process control the following steps are necessary:

1. Configuring the LPS - see chapter 8 of the Technical Description.
2. Programming process control - see chapter 9 of the Technical Description.
3. Adapt the IP configuration of the LPS such that it can communicate with the process control. This can be done either via the display of the LPS or in **LPSsoft** in the Configuration area. Here you can change network address and associated net mask as well as the ports via which the LPS communicates with process control.

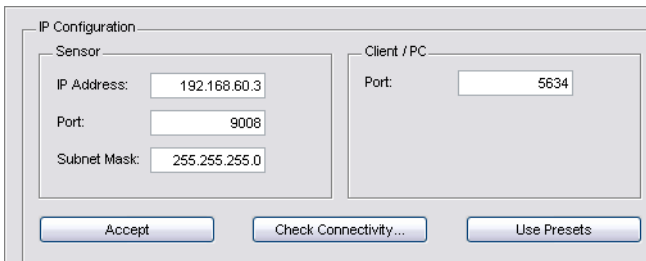

4. Save the changed settings in the LPS using the Configuration->Transmit to sensor command.
5. Connect LPS to process control via the Ethernet interface.
6. Establish connections for activation, triggering and cascading, if necessary.

Installing the software

System requirements

The PC used should meet the following requirements:

- Pentium® or faster Intel® processor > 1.5 GHz (Pentium 4, Celeron, Xeon) or compatible models by AMD® (Athlon 64, Opteron, Sempron). The processor must support the SSE2 instruction set.
- At least 512 MB free main memory (RAM), 1024 MB recommended.
- CD-ROM drive.
- Hard disk with at least 1 GB available memory.
- Ethernet port.
- Microsoft® Windows XP SP2/3 / Vista SP1 / Windows 7 (32 bit, 64 bit).

Installation procedure



Notice!

If present, uninstall Matlab Runtime before beginning with the installation of the LXSsoft Suite.

The LXSsoft_Suite_Setup.exe installation program is located on the supplied CD.



Notice!

Copy this file from the CD to an appropriate folder on your hard drive.

Administrator privileges are required for the next steps.

To start the installation process, double-click on file LXSsoft_Suite_Setup.exe.

In the first window, click on Next.

In the next window, you can select whether you would like to install LPSsoft only, or LRSsoft in addition.

You will need LRSsoft in addition, for configuring light section sensors of the LRS series with your PC.

You cannot deselect the first option, MATLAB Compiler Runtime, since this component is needed in all cases.

Select the desired options and click on Next and, in the next window, click on Install.

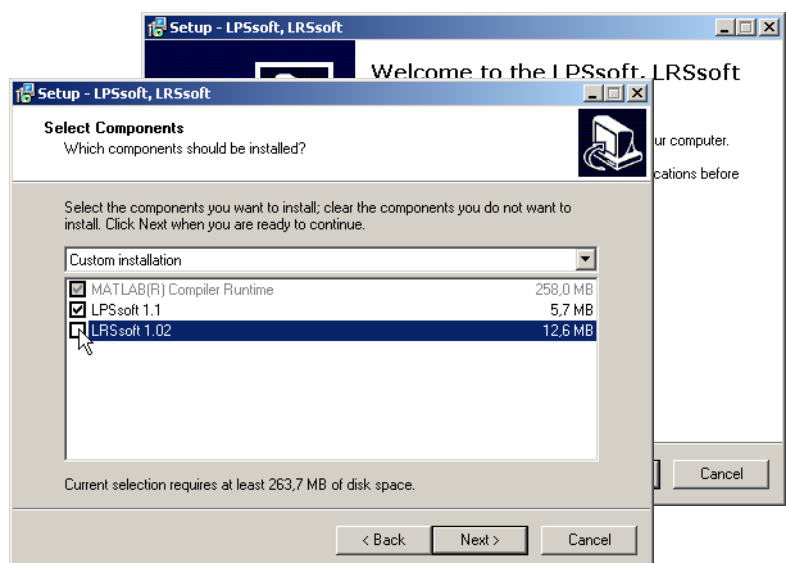

The installation routine starts. After a few seconds, the window for selecting the installation language for the Matlab Compiler Runtime (MCR) appears. The MCR is used for 3D visualization in **LPSsoft**. It is only available in English or Japanese.

☞ Therefore keep in the Choose Setup Language window the selection English and click on OK.

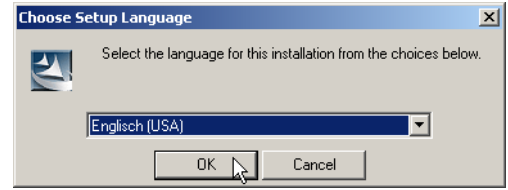

Depending on the configuration of your Windows system the adjacent dialog can also appear (missing component VCREDIST_X86).

☞ Click on Install

Two additional installation windows will appear, which do not require any further entry.

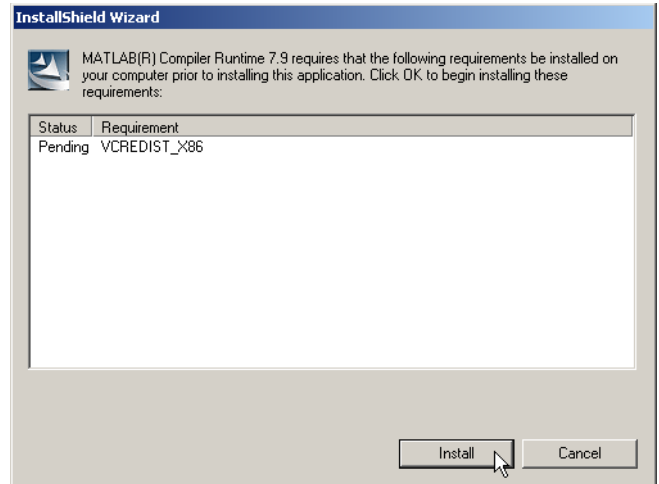

After some time (up to several minutes depending on the system configuration) the start screen of the MCR installer will appear.

☞ Click on Next.

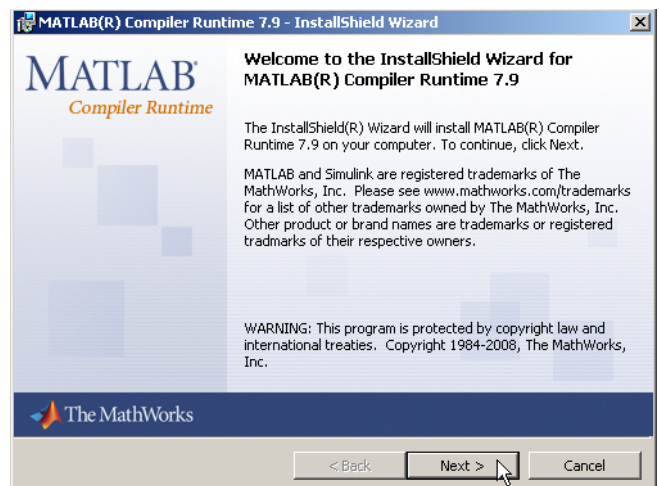

The window for entering user data appears.

☞ Enter your name and the company name and then click on Next.

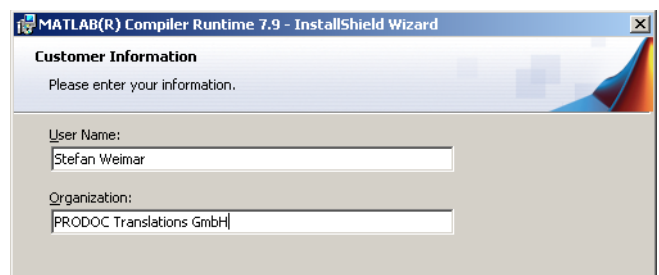

☞ It is essential that you retain the default folder in the window for the selection of the installation path (Destination Folder).

The standard path is

C:\Programs\MATLAB\MATLAB Compiler Runtime\.

☞ Click on Next and in the next window click on Install.

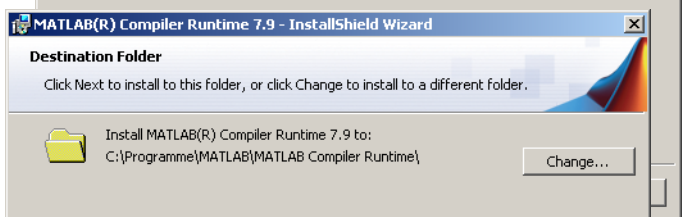

LPS 36 HI

Line profile sensor

The installation will start and the adjacent status window will be displayed. This can again take several minutes.

Following successful MCR installation, the InstallShield Wizard Completed window appears.

☞ Click on **Finish** to end the MCR-installation.

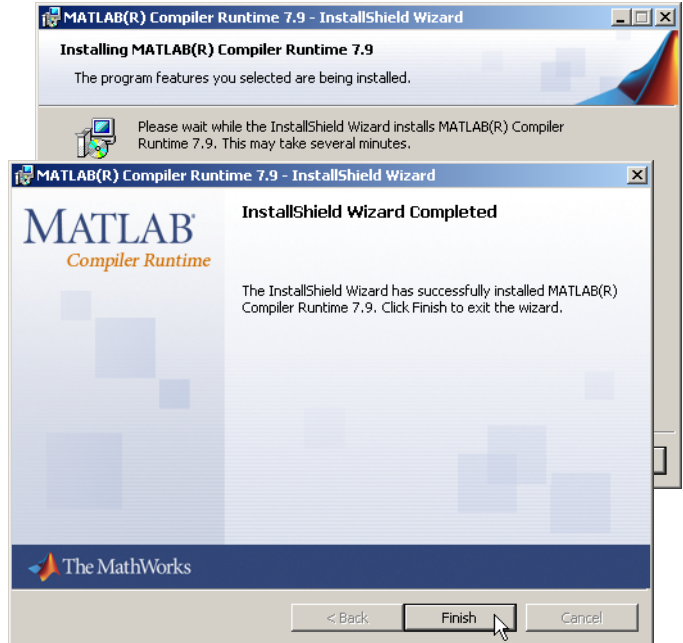

The window for selecting the installation path for **LPSsoft** now appears.

☞ Keep the default folder and click on **Next**.

The installation of **LPSsoft** starts. If you also selected **LRSsoft** for installation, upon completion of the **LPSsoft** installation, the same window then reappears for entering the installation path for **LRSsoft**.

☞ Keep the default folder in this case as well and click on **Next**.

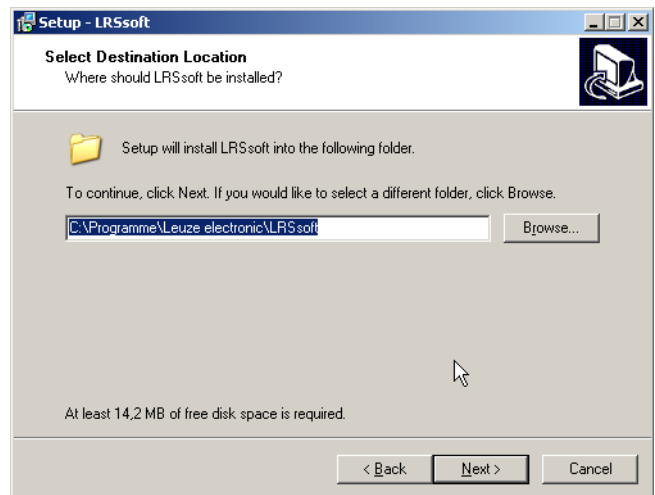

Upon completion of the installation process, the adjacent window appears.

The installation routine added a new **Leuze electronic** program group in your Start menu that contains the installed programs **LPSsoft** and, if selected, **LRSsoft**.

☞ Click on **Finish** and then start the desired program from the Start menu.

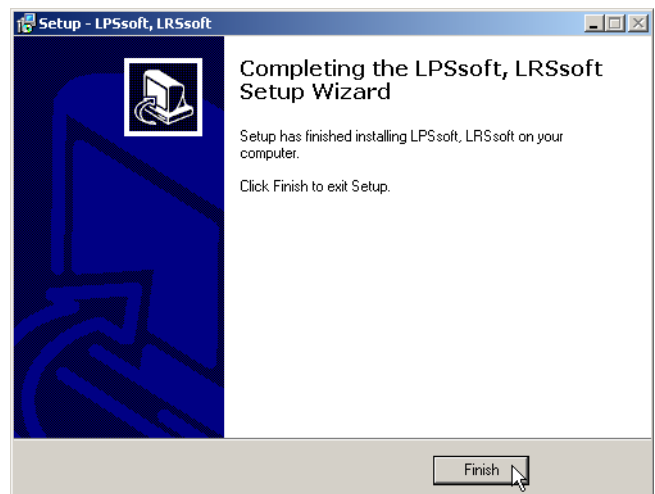

Possible error message

Depending on the system configuration the adjacent error message can appear at this point. The cause of this error message is a bug in the MCR installation routine, which does not set the environment variable Path correctly in some systems.



That, however, can easily be corrected without reinstallation of the MCR.

- ↳ Open the System properties window located in the System control of Windows under System.
- ↳ Go to the Advanced tab and click on Environment variables.

The Environment variables window opens.

- ↳ Scroll down in the System variables area until you find the Path entry.
- ↳ Click on Path and then on Edit.

The Edit system variable window opens.

There in the Variable value field you will find the ;C:\Programs\MATLAB\MATLAB Compiler Runtime\v79\runtime\win32 entry right at the end.

- ↳ If this entry is missing, copy the entry from this document and insert it together with the preceding semicolon.
- ↳ Then click on OK and close also all further windows using OK.
- ↳ Shut Windows down, restart Windows and then start LPSsoft by double-clicking on it.

Now the start screen of LPSsoft appears, as described in chapter 8 of the technical description LPS.

