

Technical data sheet

Throughbeam photoelectric sensor transmitter

Part no.: 50148179

LS55C/8X-5000



Figure can vary

Contents

- Technical data
- Dimensioned drawings
- Electrical connection
- Diagrams
- Operation and display
- Part number code
- Notes
- Further information
- Accessories



Technical data

Basic data

| | |
|---------------------|-----------------------|
| Series | 55C |
| Operating principle | Throughbeam principle |
| Device type | Transmitter |

Special version

| | |
|-----------------|--------------------------------------|
| Special version | Activation input Wash-Down design |
|-----------------|--------------------------------------|

Optical data

| | |
|--------------------------------------|--------------------------------------|
| Operating range | Guaranteed operating range |
| Operating range | 0.05 ... 8.5 m |
| Operating range limit | Typical operating range |
| Operating range limit | 0.05 ... 10 m |
| Beam path | Divergent |
| Light source | LED, Red |
| Wavelength | 645 nm |
| Transmitted-signal shape | Pulsed |
| LED group | Exempt group (in acc. with EN 62471) |
| Light spot size [at sensor distance] | 4 mm [100 mm] |
| Type of light spot geometry | Round |

Electrical data

| | |
|--------------------|---|
| Protective circuit | Polarity reversal protection Short circuit protected |
|--------------------|---|

Performance data

| | |
|----------------------|--|
| Supply voltage U_B | 10 ... 30 V, DC, Incl. residual ripple |
| Residual ripple | 0 ... 15 %, From U_B |
| Open-circuit current | 0 ... 15 mA |

Inputs

| | |
|-----------------------------|------------|
| Number of activation inputs | 1 Piece(s) |
|-----------------------------|------------|

Activation inputs

| | |
|-------------------|------------------------------------|
| Voltage type | DC |
| Switching voltage | high: $\geq 8V$ low: $\leq 2 V$ |

Activation input 1

| | |
|------------------------|------|
| Active switching state | High |
|------------------------|------|

Time behavior

| | |
|-----------------|--------|
| Readiness delay | 300 ms |
|-----------------|--------|

Connection

Connection 1

| | |
|----------------------|-----------------------------|
| Function | Signal IN Voltage supply |
| Type of connection | Cable |
| Cable length | 5,000 mm |
| Sheathing material | PVC |
| Cable color | Black |
| Number of conductors | 4 -wire |
| Wire cross section | 0.2 mm ² |

Mechanical data

| | |
|---------------------------------|--|
| Dimension (W x H x L) | 14 mm x 35.4 mm x 25 mm |
| Housing material | Stainless steel |
| Material of operational control | Plastic (POM Hostaform C9021, copoly-ester Tritan TX1001), non-diffusive |
| Housing roughness | Ra $\leq 0,8$, Typical value for the stainless steel housing |
| Stainless steel housing | AISI 316L, DIN X2CrNiMo17132, W. No1.4404 |
| Lens cover material | Plastic (PMMA+) with scratch-resistant Indium protective coating |
| Net weight | 210 g |
| Housing color | Silver |
| Type of fastening | Through-hole mounting Via optional mounting device |
| Compatibility of materials | CleanProof+ ECOLAB Johnson Diversey |

Operation and display

| | |
|-----------------|------------|
| Type of display | LED |
| Number of LEDs | 2 Piece(s) |

Environmental data

| | |
|--------------------------------|---------------|
| Ambient temperature, operation | -40 ... 70 °C |
| Ambient temperature, storage | -40 ... 70 °C |

Certifications

| | |
|----------------------|--------------------------|
| Degree of protection | IP 67 IP 68 IP 69K |
| Protection class | III |
| Certifications | c UL US |
| Standards applied | IEC 60947-5-2 |

Classification

| | |
|-----------------------|----------|
| Customs tariff number | 85365019 |
| ECLASS 5.1.4 | 27270901 |
| ECLASS 8.0 | 27270901 |
| ECLASS 9.0 | 27270901 |
| ECLASS 10.0 | 27270901 |
| ECLASS 11.0 | 27270901 |
| ECLASS 12.0 | 27270901 |
| ETIM 5.0 | EC002716 |
| ETIM 6.0 | EC002716 |
| ETIM 7.0 | EC002716 |
| ETIM 8.0 | EC002716 |

Dimensioned drawings

All dimensions in millimeters

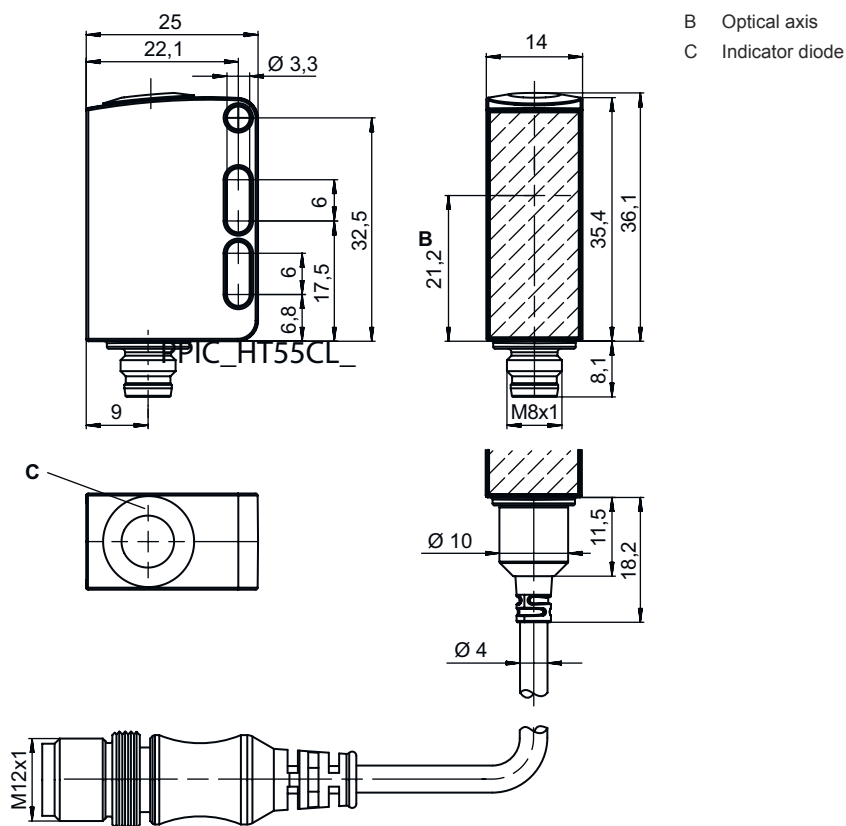

Electrical connection

Connection 1

| | |
|----------------------|---------------------|
| Function | Signal IN |
| | Voltage supply |
| Type of connection | Cable |
| Cable length | 5,000 mm |
| Sheathing material | PVC |
| Cable color | Black |
| Number of conductors | 4 -wire |
| Wire cross section | 0.2 mm ² |

Conductor color

Conductor assignment

| | |
|-------|------|
| Brown | V+ |
| White | n.c. |
| Blue | GND |
| Black | IN 1 |

Diagrams

Typ. response behavior

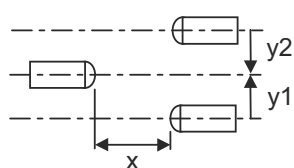
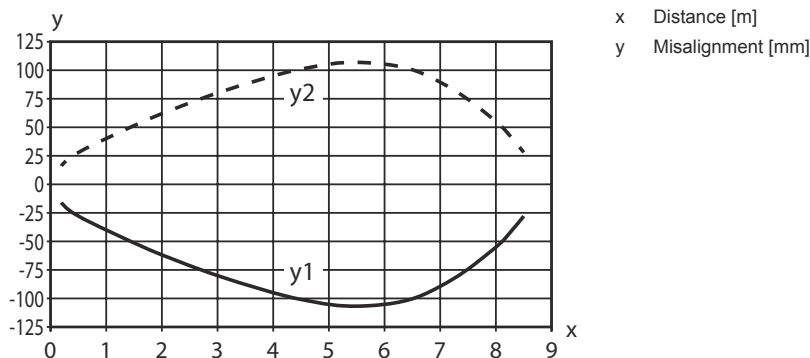

Operation and display

| LED | Display | Meaning |
|-----|--------------------------|-------------------------|
| 1 | Green, continuous light | Operational readiness |
| 2 | Yellow, continuous light | Transmitted beam active |

Part number code

Part designation: AAA55C d EE-f.GGGG H/i J-K

| | |
|---------------|--|
| AAA55C | Operating principle / construction HT55C: Diffuse reflection sensor with background suppression LS55C: Throughbeam photoelectric sensor transmitter LE55C: Throughbeam photoelectric sensor receiver PRK55C: Retro-reflective photoelectric sensor with polarization filter ODT55C: Distance diffuse sensor with background suppression |
| d | Light type n/a: red light I: infrared light |
| EE | Light source n/a: LED L1: laser class 1 L2: laser class 2 |
| f | Preset range (optional) n/a: operating range acc. to data sheet xxxF: Preset range [mm] |
| GGGG | Equipment n/a: standard A: Autocollimation principle (single lens) for positioning tasks F: Permanently set range H2O: Detection of aqueous liquids Fill-level monitoring S: small light spot T: autocollimation principle (single lens) for highly transparent bottles without tracking TT: autocollimation principle (single lens) for highly transparent bottles with tracking V: V-optics XL: Extra long light spot |

Part number code

| | |
|----------|---|
| H | Operating range adjustment n/a with HT: range adjustable via 8-turn potentiometer n/a with retro-reflective photoelectric sensors (PRK): operating range not adjustable 1: 270° potentiometer 3: teach-in via button |
| i | Switching output/function OUT 1/IN: Pin 4 or black conductor 2: NPN transistor output, light switching N: NPN transistor output, dark switching 4: PNP transistor output, light switching P: PNP transistor output, dark switching 6: push-pull switching output, PNP light switching, NPN dark switching G: Push-pull switching output, PNP dark switching, NPN light switching L: IO-Link interface (SIO mode: PNP light switching, NPN dark switching) 8: activation input (activation with high signal) X: pin not used 1: IO-Link / light switching (NPN) / dark switching (PNP) 7: Input for sensitivity adjustment |
| J | Switching output / function OUT 2/IN: pin 2 or white conductor 2: NPN transistor output, light switching N: NPN transistor output, dark switching 4: PNP transistor output, light switching P: PNP transistor output, dark switching 6: push-pull switching output, PNP light switching, NPN dark switching G: Push-pull switching output, PNP dark switching, NPN light switching T: teach-in via cable X: pin not used 8: activation input (activation with high signal) 9: deactivation input (deactivation with high signal) 7: Input for sensitivity adjustment |
| K | Electrical connection n/a: cable, standard length 2000 mm, 4-wire 5000: cable, standard length 5000 mm, 4-wire M8: M8 connector, 4-pin (plug) M8.3: M8 connector, 3-pin (plug) 200-M12: cable, length 200 mm with M12 connector, 4-pin, axial (plug) |

Note

| | |
|--|---|
|  | <ul style="list-style-type: none"> A list with all available device types can be found on the Leuze website at www.leuze.com. |
|--|---|

Notes



Observe intended use!

| | |
|--|---|
|  | <ul style="list-style-type: none"> This product is not a safety sensor and is not intended as personnel protection. The product may only be put into operation by competent persons. Only use the product in accordance with its intended use. |
|--|---|

For UL applications:



| | |
|--|---|
|  | <ul style="list-style-type: none"> For UL applications, use is only permitted in Class 2 circuits in accordance with the NEC (National Electric Code). These proximity switches shall be used with UL Listed Cable assemblies rated 30V, 0.5A min, in the field installation, or equivalent (categories: CYJV/ CYJV7 or PVVA/PVVA7) |
|--|---|

Further information



- Light source: Average life expectancy 100,000h at an ambient temperature of 25 °C
- Response time: For short decay times, an ohmic load of approx. 5kOhm is recommended
- Sum of the output currents for both outputs, 50 mA for ambient temperatures > 40 °C
- Permissible operating temperature range during IO-Link operation: -10 °C to +60 °C
- Ambient temperature, operation: +70 °C permissible only briefly (≤ 15min)
- IP 69K only in combination with connector

Accessories

Mounting technology - Mounting brackets

| | Part no. | Designation | Article | Description |
|--|----------|-------------|------------------|---|
|  | 50118542 | BT 200M.5 | Mounting bracket | Design of mounting device: Angle, L-shape Fastening, at system: Through-hole mounting Mounting bracket, at device: Screw type, Suited for M3 screws Type of mounting device: Adjustable Material: Stainless steel |
|  | 50040269 | BT 25 | Mounting device | Design of mounting device: Angle, L-shape Fastening, at system: Through-hole mounting Mounting bracket, at device: Screw type Type of mounting device: Rigid Material: Metal |

Mounting technology - Rod mounts

| | Part no. | Designation | Article | Description |
|---|----------|----------------|-----------------|--|
|  | 50117255 | BTU 200M-D12 | Mounting system | Design of mounting device: Mounting system Fastening, at system: For 12 mm rod, Sheet-metal mounting Mounting bracket, at device: Screw type, Suited for M3 screws Type of mounting device: Clampable, Adjustable, Turning, 360° Material: Metal |
|  | 50120426 | BTU 200M.5-D12 | Mounting system | Design of mounting device: Mounting system Fastening, at system: For 12 mm rod Mounting bracket, at device: Screw type, Suited for M3 screws Type of mounting device: Turning, 360°, Adjustable, Clampable Material: Stainless steel |

Note



A list with all available accessories can be found on the Leuze website in the Download tab of the article detailed page.