

Technical data sheet

Fiber optic amplifier

Part no.: 50145468

LV462B/24-150-M8

Contents

- Technical data
- Dimensioned drawings
- Electrical connection
- Notes
- Accessories



Figure can vary



Technical data

Basic data

Series	462B
Suitable for	Glass fiber optics Plastic fiber optics

Optical data

Light source	LED, Red
Wavelength	660 nm
Transmitted-signal shape	Pulsed

Electrical data

Protective circuit	Polarity reversal protection Short circuit protected
Fiber optic connection	Clamp

Performance data

Supply voltage U_B	12 ... 24 V, DC
Residual ripple	0 ... 30 %, From U_B
Open-circuit current	0 ... 40 mA

Outputs

Number of digital switching outputs	2 Piece(s)
-------------------------------------	------------

Switching outputs

Type	Digital switching output
Voltage type	DC
Switching current, max.	100 mA
Switching voltage	high: $\geq(U_B - 2.5V)$ low: $\leq 2.5 V$

Switching output 1

Switching element	Transistor, NPN
Switching principle	Light/dark switchable

Switching output 2

Switching element	Transistor, PNP
Switching principle	Light/dark switchable

Time behavior

Switching frequency	1,500 Hz
Response time	0.33 ms
Switch-on/-off delay	Switch-on/-off delay
Readiness delay	500 ms
Wiping contact	Wiping contact

Connection

Number of connections	1 Piece(s)
-----------------------	------------

Connection 1

Function	Signal OUT Voltage supply
Type of connection	Cable with connector
Cable length	150 mm
Cable color	Black
Number of conductors	4 -wire
Thread size	M8

Mechanical data

Design	Cubic
Dimension (W x H x L)	10 mm x 33 mm x 79.4 mm
Housing material	Plastic
Plastic housing	ABS
Net weight	30 g
Housing color	Black
Type of fastening	Via optional mounting device

Operation and display

Type of display	LED
Number of LEDs	1 Piece(s)
Operational controls	Control buttons
Function of the operational control	Sensitivity adjustment Switching range adjustment

Environmental data

Ambient temperature, operation	-10 ... 60 °C
Relative humidity (non-condensing)	35 ... 85 %

Certifications

Degree of protection	IP 50
Standards applied	IEC 60947-5-2

Classification

Customs tariff number	85423390
ECLASS 5.1.4	27270905
ECLASS 8.0	27270905
ECLASS 9.0	27270905
ECLASS 10.0	27270905
ECLASS 11.0	27270905
ECLASS 12.0	27270905
ECLASS 13.0	27270905
ETIM 5.0	EC002651
ETIM 6.0	EC002651
ETIM 7.0	EC002651
ETIM 8.0	EC002651

Dimensioned drawings

All dimensions in millimeters

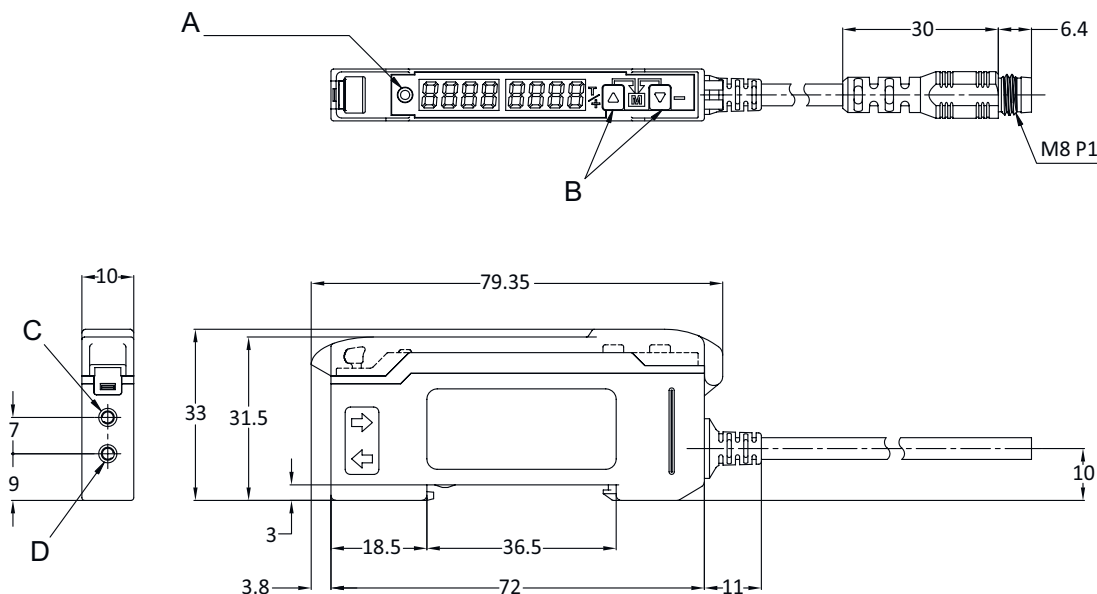

- A LED indicator
- B Sensitivity adjustment
- C Connection for fiber optics receiver
- D Connection for fiber optics transmitter

Electrical connection

Connection 1



Function	Signal OUT
	Voltage supply
Type of connection	Cable with connector
Cable length	150 mm
Cable color	Black
Number of conductors	4 -wire
Thread size	M8
Type	Male
Material	Plastic
No. of pins	4 -pin

Pin Pin assignment

Pin	Pin assignment
1	V+
2	OUT 2
3	GND
4	OUT 1









Notes

 Observe intended use!	
	<ul style="list-style-type: none"> ⌘ This product is not a safety sensor and is not intended as personnel protection. ⌘ The product may only be put into operation by competent persons. ⌘ Only use the product in accordance with its intended use.

Accessories

Connection technology - Connection cables

	Part no.	Designation	Article	Description
  	50130850	KD U-M8-4A-V1-050	Connection cable	Connection 1: Connector, M8, Axial, Female, 4 -pin Connector, LED: No Connection 2: Open end Shielded: No Cable length: 5.000 mm Sheathing material: PVC
  	50130871	KD U-M8-4W-V1-050	Connection cable	Connection 1: Connector, M8, Angled, Female, 4 -pin Connector, LED: No Connection 2: Open end Shielded: No Cable length: 5.000 mm Sheathing material: PVC

Note	
	<ul style="list-style-type: none"> ⌘ A list with all available accessories can be found on the Leuze website in the Download tab of the article detailed page.