

Technical data sheet

Optical distance sensor

Part no.: 50138326
ODS9L2.8/LFH-100-M12

Contents

- Technical data
- Electrical connection
- Diagrams
- Operation and display
- Notes
- Accessories



For illustration purposes only



Technical data

Basic data

Series	9
Type of scanning system	Against object

Characteristic parameters

MTTF	36 years
------	----------

Optical data

Beam path	Divergent
Light source	Laser, Red
Wavelength	655 nm
Laser class	2, IEC/EN 60825-1:2014
Transmitted-signal shape	Pulsed
Light spot size [at sensor distance]	1 mm [100 mm]
Type of light spot geometry	Round

Measurement data

Measurement range	50 ... 100 mm
Resolution	0.01 mm
Accuracy	0.5 %
Reference value, accuracy	Measurement distance
Reproducibility (1 sigma)	0.05 mm
Temperature drift, relative	0.02 %/K
Referencing	No
Optical distance measurement principle	Triangulation

Electrical data

Protective circuit	Polarity reversal protection
	Short circuit protected
	Transient protection
Performance data	
Supply voltage U_B	10 ... 30 V, DC
Residual ripple	0 ... 15 %, From U_B
Open-circuit current	0 ... 180 mA

Outputs

Number of digital switching outputs 1 Piece(s)

Switching outputs

Voltage type	DC
Switching voltage	high: $\geq(U_B - 2V)$

Switching output 1

Assignment	Connection 1, pin 4
Switching element	Transistor, Push-pull
Switching principle	Light switching (PNP)/dark switching (NPN)

Time behavior

Response time	1 ms, Under constant ambient conditions, 90% diffuse reflection, standard measure mode
Readiness delay	300 ms

Interface

Type	RS 232
------	--------

RS 232

Function	Process
Transmission speed	2,400 ... 230,400 Bd
Start bit	1
Data bit	8
Stop bit	1
Transmission protocol	Adjustable
Data encoding	14 bit HEX
	16 bit HEX
	24 bit HEX
	ASCII
	Decimal measurement value
	Remote Control (ASCII)

Connection

Number of connections	1 Piece(s)
-----------------------	------------

Connection 1

Function	Signal OUT
	Voltage supply
Type of connection	Connector, Turning, 90°
Thread size	M12
Type	Male
Material	Plastic
No. of pins	5 -pin
Encoding	A-coded

Mechanical data

Design	Cubic
Dimension (W x H x L)	21 mm x 50 mm x 50 mm
Housing material	Plastic
Plastic housing	PC
Lens cover material	Glass
Net weight	50 g
Housing color	Red
Type of fastening	Through-hole mounting
	Via optional mounting device

Operation and display

Type of display	OLED display
Number of LEDs	2 Piece(s)
Type of configuration	Software
Operational controls	Control buttons
	LC Display
	PC software

Environmental data

Ambient temperature, operation	-20 ... 50 °C
Ambient temperature, storage	-30 ... 70 °C
Ambient light sensitivity	20,000 lx, EN 60947-5-2

Certifications

Degree of protection	IP 67
Protection class	II
Certifications	c UL US
Standards applied	IEC 60947-5-2

Technical data

Customs tariff number	90318020
ECLASS 5.1.4	27270801
ECLASS 8.0	27270801
ECLASS 9.0	27270801
ECLASS 10.0	27270801
ECLASS 11.0	27270801
ECLASS 12.0	27270916
ECLASS 13.0	27270916
ETIM 5.0	EC001825
ETIM 6.0	EC001825
ETIM 7.0	EC001825
ETIM 8.0	EC001825

Electrical connection

Connection 1

Function	Signal OUT
	Voltage supply
Type of connection	Connector
Thread size	M12
Type	Male
Material	Plastic
No. of pins	5 -pin
Encoding	A-coded

Pin Pin assignment

1	18 ... 30 V DC +
2	RS 232 RxD
3	GND
4	IO-Link / OUT 1
5	RS 232 TxD

Diagrams

Accuracy of measurement

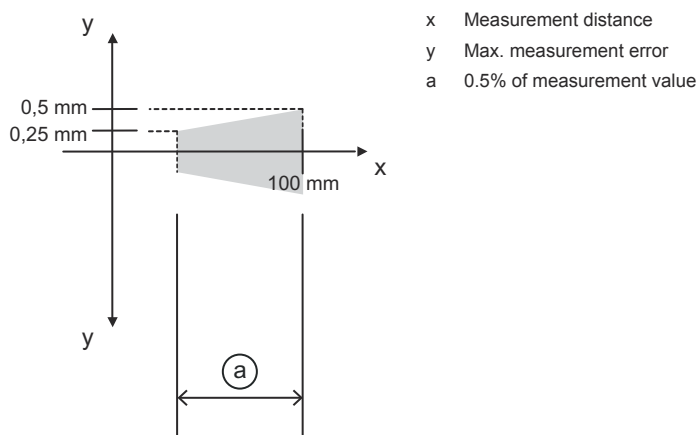

Operation and display

LED	Display	Meaning
1	Green, continuous light	Operational readiness
	Green, flashing	Fault
	Off	No supply voltage
2	Yellow, continuous light	Object in the measurement range
	Off	No object in the measurement range

Notes



Observe intended use!



- ⌘ This product is not a safety sensor and is not intended as personnel protection.
- ⌘ The product may only be put into operation by competent persons.
- ⌘ Only use the product in accordance with its intended use.



ATTENTION! LASER RADIATION – CLASS 2 LASER PRODUCT



Do not stare into beam!

The device satisfies the requirements of IEC 60825-1:2007 (EN 60825-1:2007) safety regulations for a product of **laser class 2** as well as the U.S. 21 CFR 1040.10 regulations with deviations corresponding to Laser Notice No. 50 from June 24, 2007.

- ⌘ Never look directly into the laser beam or in the direction of reflected laser beams! If you look into the beam path over a longer time period, there is a risk of injury to the retina.
- ⌘ Do not point the laser beam of the device at persons!
- ⌘ Interrupt the laser beam using a non-transparent, non-reflective object if the laser beam is accidentally directed towards a person.
- ⌘ When mounting and aligning the device, avoid reflections of the laser beam off reflective surfaces!
- ⌘ CAUTION! Use of controls or adjustments or performance of procedures other than specified herein may result in hazardous light exposure.
- ⌘ Observe the applicable statutory and local laser protection regulations.
- ⌘ The device must not be tampered with and must not be changed in any way.
There are no user-serviceable parts inside the device.
Repairs must only be performed by Leuze electronic GmbH + Co. KG.

NOTE







Affix laser information and warning signs!

Laser information and warning signs are affixed to the device. In addition, self-adhesive laser information and warning signs (stick-on labels) are supplied in several languages.

- ⌘ Affix the laser information sheet to the device in the language appropriate for the place of use. When using the device in the US, use the stick-on label with the "Complies with 21 CFR 1040.10" note.
- ⌘ Affix the laser information and warning signs near the device if no signs are attached to the device (e.g. because the device is too small) or if the attached laser information and warning signs are concealed due to the installation position.
- ⌘ Affix the laser information and warning signs so that they are legible without exposing the reader to the laser radiation of the device or other optical radiation.

Accessories

Connection technology - Connection cables

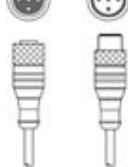
	Part no.	Designation	Article	Description
	50132077	KD U-M12-5A-V1-020	Connection cable	Connection 1: Connector, M12, Axial, Female, A-coded, 5 -pin Connector, LED: No Connection 2: Open end Shielded: No Cable length: 2.000 mm Sheathing material: PVC
	50132079	KD U-M12-5A-V1-050	Connection cable	Connection 1: Connector, M12, Axial, Female, A-coded, 5 -pin Connector, LED: No Connection 2: Open end Shielded: No Cable length: 5.000 mm Sheathing material: PVC
	50133842	KD U-M12-5W-V1-020	Connection cable	Connection 1: Connector, M12, Angled, Female, A-coded, 5 -pin Connector, LED: No Connection 2: Open end Shielded: No Cable length: 2.000 mm Sheathing material: PVC
	50133802	KD U-M12-5W-V1-050	Connection cable	Connection 1: Connector, M12, Angled, Female, A-coded, 5 -pin Connector, LED: No Connection 2: Open end Shielded: No Cable length: 5.000 mm Sheathing material: PVC
	50140174	KDS U-M12-5A-M12-5A-P1-003-25X	Interconnection cable	Connection 1: Connector, M12, Axial, Female, A-coded, 5 -pin Connection 2: Connector, M12, Axial, Male, A-coded, 5 -pin Shielded: No Cable, crossed: Connection 1, pin 2 <-> connection 2, pin 5 Cable length: 300 mm Sheathing material: PUR

Mounting technology - Mounting brackets

	Part no.	Designation	Article	Description
	50036195	BT 8	Mounting device	Design of mounting device: Angle, L-shape Fastening, at system: Through-hole mounting Mounting bracket, at device: Screw type Type of mounting device: Rigid Material: Metal

Accessories**Mounting technology - Rod mounts**

	Part no.	Designation	Article	Description
	50117252	BTU 300M-D12	Mounting system	Design of mounting device: Mounting system Fastening, at system: For 12 mm rod, Sheet-metal mounting Mounting bracket, at device: Screw type, Suited for M4 screws Type of mounting device: Clampable, Adjustable, Turning, 360° Material: Metal

Note

A list with all available accessories can be found on the Leuze website in the Download tab of the article detailed page.