

DMU418B

ADVANCED ultrasonic sensors with analog output

Dimensioned drawing

en 07-2017/02 50124880

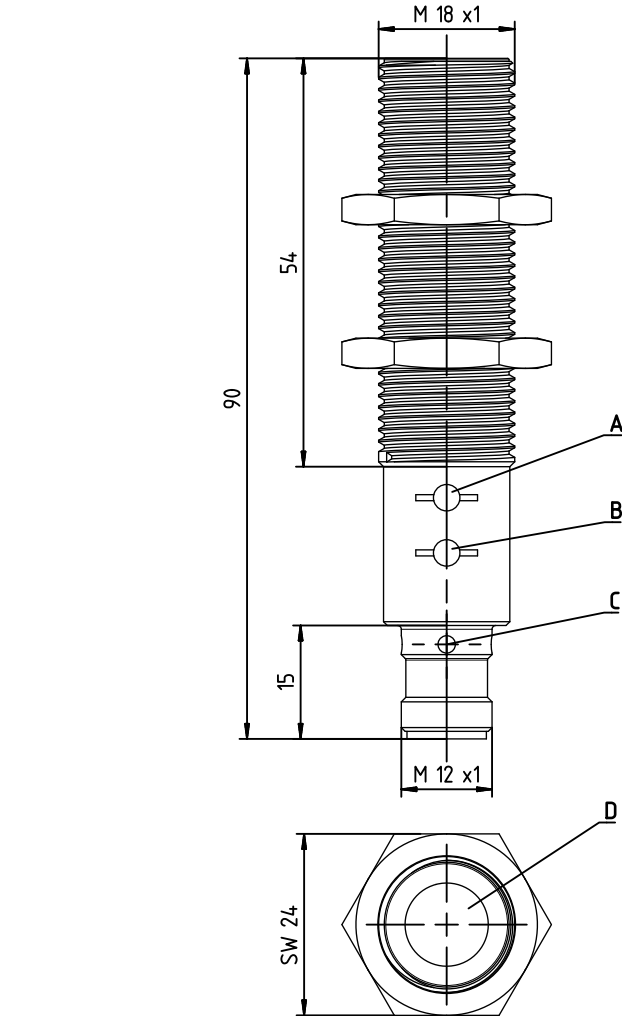

- A Control button 2
- B Control button 1
- C Indicator diodes
- D Active sensor surface

Electrical connection

DMU418B-...X3/LTV-M12
DMU418B-...X3/LTC-M12

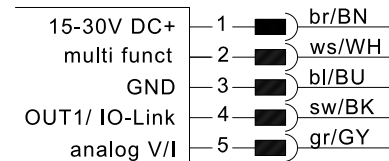

Factory setting for pin 2 **multi funct**: teach input

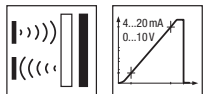

25 ... 400 mm
150 ... 1300 mm



- Function largely independent of surface properties, ideal for detection of liquids, bulk materials, transparent media, ...
- Small dead zone at long scanning range
- Temperature-compensated scanning range and measurement range
- 1 PNP switching output (NPN) and 1 analog output 0 ... 10V / 4 ... 20mA
- **NEW** – Both outputs can easily be taught using a button
- **NEW** – Stable, all-metal design
- **NEW** – Process data and configuration via IO-Link interface
- **NEW** – Five operating modes: scanning, synchronous, multiplex, activation and throughbeam operation

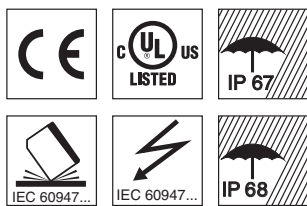

Accessories:

(available separately)

- Mounting systems
- Mounting adapter M18-M30: BTX-D18M-D30 (Part no. 50125860)
- Cables with M12 connector (K-D ...)
- Teach adapter PA1/XTSX-M12 (Part no. 50124709)
- USB IO-Link master 2.0 (Part no. 50121098)

We reserve the right to make changes • PAL_DMU418BX3LTV_en_50124880.fm

Specifications

Ultrasonic specifications

Scanning range ¹⁾
 Adjustment range
 Ultrasonic frequency
 Typ. opening angle
 Resolution switching output
 Resolution analog output
 Direction of beam
 Accuracy (analog output)
 Reproducibility
 Switching hysteresis (OUT1)
 Temperature drift

DMU418B-400.X3/...

25 ... 400mm ²⁾
 25 ... 400mm
 310kHz
 9°
 0.5mm
 0.1mm
 axial
 ± 0.5% of end value ¹⁾
 ± 0.15% of end value ¹⁾
 5mm
 ± 1.5% of end value ¹⁾

DMU418B-1300.X3/...

150 ... 1300mm ³⁾
 150 ... 1300mm
 200kHz
 16°
 1mm
 0.1mm
 axial
 ± 0.5% of end value ¹⁾
 ± 0.15% of end value ¹⁾
 10mm
 ± 1.5% of end value ¹⁾

Sensor operating modes

IO-Link
 SIO

COM2 (38.4kBaod)
 is supported

Timing

Switching frequency
 Response time
 Delay before start-up

7Hz
 71ms
 < 300ms

8Hz
 62ms
 < 300ms

Electrical data

Operating voltage U_B ⁴⁾

Residual ripple
 Open-circuit current
 Switching output
 Function (PNP)
 Output current

SIO mode: 15 ... 30V DC (incl. ± 10% residual ripple),
 COM2 mode: 18 ... 30V DC (incl. ± 10% residual ripple)
 ± 10% of U_B
 ≤ 50mA

OUT1: 1 x PNP transistor output, IO-Link SIO mode
 NO contact, reversible
 SIO mode: max. 150mA per contact,
 COM2 mode: max. 100mA per contact
 OUT1: control button 1 or teach input
 OUT1: control button 1 or teach input
 voltage output 0 ... 10V, teachable, configurable,
 current output 4 ... 20mA, teachable, configurable
 distance too small: approx. 3.8mA,
 distance too large: approx. 11V / approx. 21mA

Switching range adjustment
 Changeover NO/NC
 Analog output

...X3/LTV
 ...X3/LTC

Error signal (analog output)

Indicators

Yellow LED
 Yellow LED, flashing

Green LED
 Green LED flashing
 Yellow and green LEDs flash

OUT1: object detected
 teach-in / teaching error for 1-point teach /
 cable short circuit
 object within the scanning range
 IO-Link communication
 teach-in/teaching error for window-teach

Mechanical data

Housing
 Weight
 Ultrasonic transducer
 Connection type
 Fitting position

all metal - brass, nickel-plated
 50g
 piezoceramic ⁵⁾
 M12 connector, 5-pin
 any

Environmental data

Ambient temp. (operation/storage)
 Protective circuit ⁶⁾
 VDE safety class
 Degree of protection
 Standards applied
 Certifications

-25°C ... +70°C/-30°C ... +85°C
 1, 2, 3
 III
 IP 67 and IP 68
 EN 60947-5-2
 UL 508, C22.2 No.14-13 ^{4) 7)8)}

- 1) At 20°C
- 2) Target: 20mm x 20mm plate
- 3) Target: 100mm x 100mm plate
- 4) For UL applications: for use in class 2 circuits according to NEC only
- 5) The ceramic material of the ultrasonic transducer contains lead zirconium titanate (PZT)
- 6) 1=short-circuit and overload protection, 2=polarity reversal protection, 3=wire break and inductive protection
- 7) These proximity switches shall be used with UL Listed Cable assemblies rated 30V, 0.5A min, in the field installation, or equivalent (categories: CYJV/CYJV7 or PVVA/PVVA7);
 Use tool for buttons
- 8) Ambient temperature 85°C. Use same voltage supply for all circuits.

Diagrams

DMU418B-400...-M12

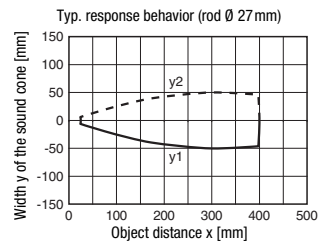
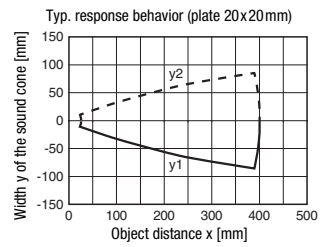

DMU418B-1300...-M12

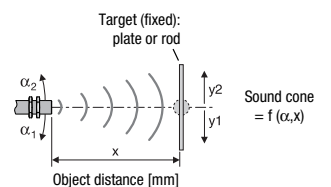
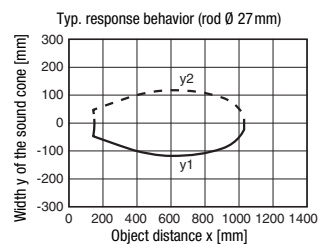
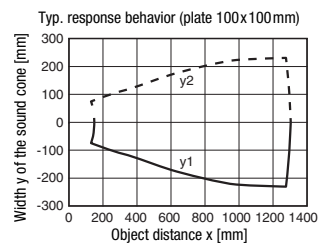
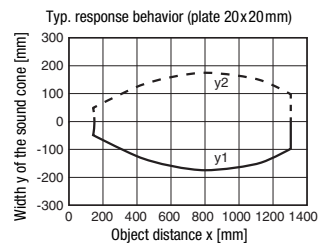

Remarks

Operate in accordance with intended use!

- ⚠ This product is not a safety sensor and is not intended as personnel protection.
- ⚠ The product may only be put into operation by competent persons.
- ⚠ Only use the product in accordance with the intended use.

DMU418B

ADVANCED ultrasonic sensors with analog output

Part number code

D	M	U	4	1	8	B	-	1	3	0	0	.	X	3	/	L	T	V	-	M	1	2
---	---	---	---	---	---	---	---	---	---	---	---	---	---	---	---	---	---	---	---	---	---	---

Operating principle

HTU Ultrasonic sensor, scanning principle, with background suppression

DMU Ultrasonic sensor, distance measurement

Series

418B 418B Series, cylindrical M18 construction

Scanning range in mm

400 25 ... 400

1300 150 ... 1300

Equipment (optional)

X "Advanced" design

3 Teach button on the sensor

Pin assignment of connector pin 4 / black cable wire (OUT1)

4 PNP output, NO contact preset

P PNP output, NC contact preset

L IO-Link communication or push-pull (SIO)

Pin assignment of connector pin 2 / white cable wire (Teach-IN)

T Teach input

Pin assignment of connector pin 5 / gray cable wire (OUT2)

4 PNP output, NO contact preset

P PNP output, NC contact preset

V Analog voltage output 0 ... 10V

C Analog current output 4 ... 20mA

X Connection not assigned (n. c. - not connected)

Connection technology

M12 M12 connector, 5-pin

Order guide

The sensors listed here are preferred types; current information at www.leuze.com.

	Designation	Part no.	
Scanning range / Analog output	25 ... 400mm / 0 ... 10V	DMU418B-400.X3/LTV-M12	50124261
	25 ... 400mm / 4 ... 20mA	DMU418B-400.X3/LTC-M12	50124260
	150 ... 1300mm / 0 ... 10V	DMU418B-1300.X3/LTV-M12	50124264
	150 ... 1300mm / 4 ... 20mA	DMU418B-1300.X3/LTC-M12	50124263

Device functions and indicators – switching output

The sensor has two buttons for adjusting switching output **OUT1** and analog output **OUT2**. Alternatively, all adjustments can also be made via **IO-Link**. The **multi funct** teach input can be used to perform the 1-point teach and the changeover of the switching function (NO contact/NC contact).

Switching output OUT1

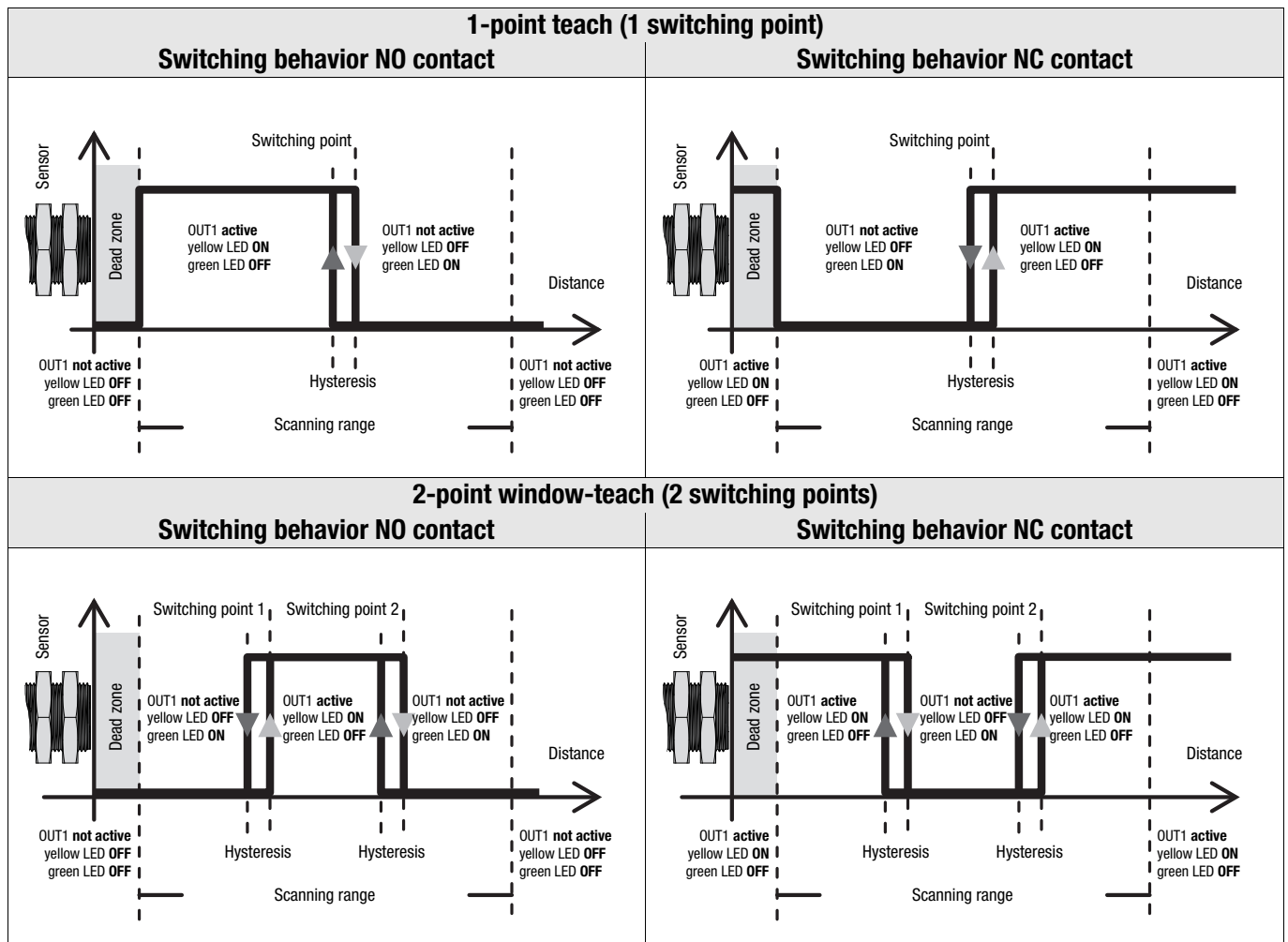

Notice!
The switching behavior is not defined in the dead zone.

Switching behavior with 2-point window-teach as a function of the switching function

Switching function configured as	First taught object distance	Second taught object distance	Output switching behavior
NO contact NC contact	Far	Close	
	Close	Far	



Notice!
In measurement operation, the yellow and green LED only indicate the behavior of output **OUT1**.
The behavior of output **OUT2** is not indicated.

DMU418B

ADVANCED ultrasonic sensors with analog output

Adjustment of the switching points (Teach) using the control buttons

The switching point of the sensor is set to 400mm or 1300mm (static 1-point teach) on delivery.

By means of a simple operating procedure, the switching point for output OUT1 can be individually taught to an arbitrary distance within the scanning range with 1-point teach (static) or 2-point window-teach (static).

Moreover, the output function can be switched from NO contact (NO - normally open) to NC contact (NC - normally closed). For the adjustment, **control button 1** is permanently assigned to output **OUT1** (see dimensioned drawing).

1-point teach (static)	2-point window-teach (static) ¹⁾
1. Place object at desired switching distance.	1. First, place object at desired switching distance for switching point 1 .
2. To adjust output OUT1, press button 1 for 2 ... 7s until the yellow LED flashes at 3Hz.	2. To adjust output OUT1, press button 1 for 7 ... 12s until the yellow and green LED flash alternately at 3Hz.
3. Release the button at the end of the teach event. The current object distance has been taught as the new switching point.	3. Release button. The sensor remains in teach mode and the LEDs continue to flash.
4. Error-free teach: LED states and switching behavior according to the diagram shown above. Faulty teach (object may be too close or too far away – please note scanning range): yellow LED flashes at 5Hz until an error-free teach event is performed. The affected output is inactive as long as there is a teach error.	4. Then, place the object at the desired switching distance for switching point 2 . Notice: The minimum distance between the switching points is as follows: scanning range of 400mm: 40mm scanning range of 1300mm: 130mm
	5. Briefly press the button again at the end of the teach event. The switching window has been taught.
	6. Error-free teach: LED states and switching behavior according to the diagram shown above. Faulty teach (object may be too close or too far away – please note scanning range): green and yellow LED flash at 8Hz until an error-free teach event is performed.

1) See table "Switching behavior with 2-point window-teach as a function of the switching function"

Adjustment of the switching function (NO/NC) using the control buttons

Control button 1 can be used to switch the switching function of output **OUT1** from NO contact to NC contact (or vice versa). To do this, proceed as follows:

Action / Description	Control button	Indicator diode	
		GREEN	YELLOW
Changeover of the switching function: Switching output OUT1 is set as NO contact ex works . If the switching function is changed, the switching output is changed to the opposite state (toggled).	Press button 1 of the switching output for longer than 12s .	Both LEDs flash alternately for a short time at 3Hz. If the yellow LED is then ON , the output functions as an NO contact . If the yellow LED is then OFF , the output functions as an NC contact .	



Notice!

For 2-point window-teach, the switching behavior is dependent on the selected object distances for switching points 1 and 2. See previous page!

Device functions – analog output

Analog output OUT2

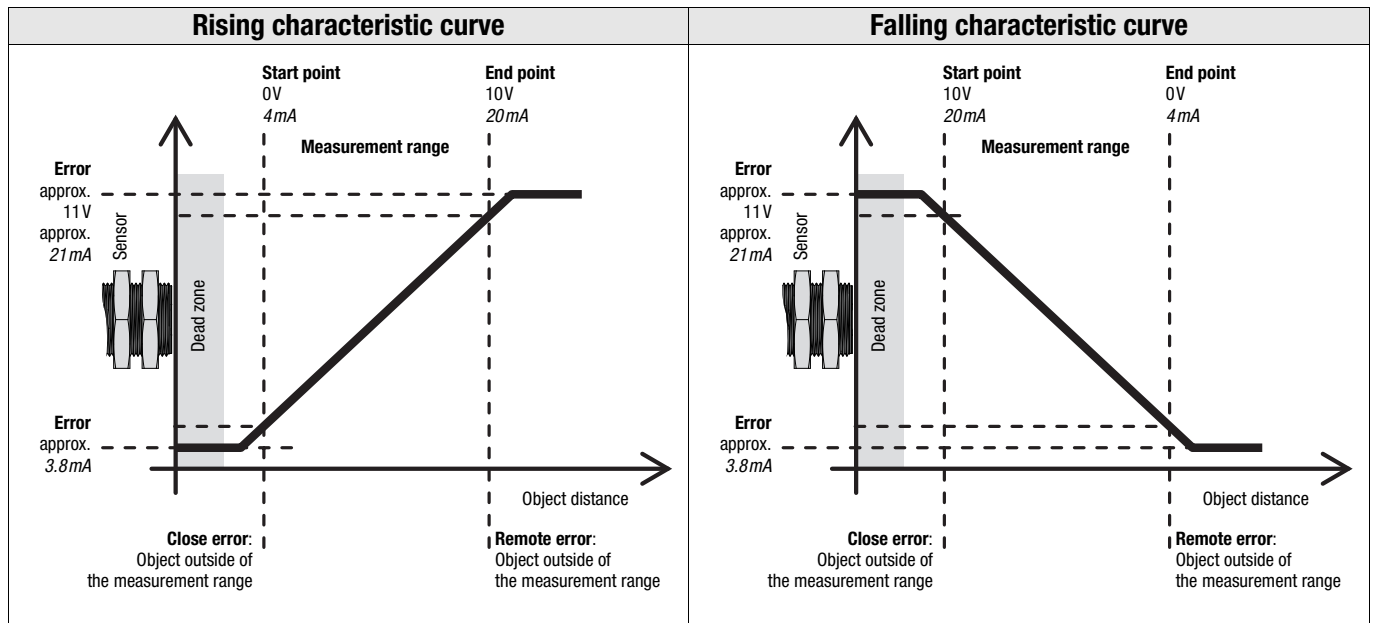

Characteristic curve behavior as a function of the object distances for start/end of measurement range

Characteristic curve configured as	First taught object distance	Second taught object distance	Characteristic curve of the analog output
Rising characteristic curve	Close	Far	
Falling characteristic curve	Far	Close	



Notice!

In measurement operation, the yellow and green LED only indicate the behavior of output OUT1. The behavior of output OUT2 is not indicated.

Adjustment of the analog output (Teach) using the control buttons

The choice of distances for start of measurement range and end of measurement range can be used to adjust the characteristic curve of the analog output.

If an object is located outside of the taught measurement range, an error signal is output. A different analog signal is output here by the sensor for the errors "distance too close: object outside of the measurement range" and "distance too far: object outside of the measurement range".

Rising characteristic curve ¹⁾	Falling characteristic curve ¹⁾
1. Place object at desired distance for the start point of the measurement range .	1. Place object at desired distance for the end point of the measurement range .
2. To adjust analog output OUT2, press button 2 for 7 ... 12s until the yellow and green LED flash alternately at 3Hz.	2. To adjust analog output OUT2, press button 2 for 7 ... 12s until the yellow and green LED flash alternately at 3Hz.
3. Release button. The sensor remains in teach mode and the LEDs continue to flash.	3. Release button. The sensor remains in teach mode and the LEDs continue to flash.
4. Then, place object at desired distance for the end point of the measurement range . Notice: The minimum distance between the start and end point of the measurement range is as follows: scanning range of 400mm: 40mm scanning range of 1300mm: 130mm	4. Then, place object at desired distance for the start point of the measurement range . Notice: The minimum distance between the start and end point of the measurement range is as follows: scanning range of 400mm: 40mm scanning range of 1300mm: 130mm
5. Briefly press the button again at the end of the teach event. The characteristic curve with rising curve has been taught.	5. Briefly press the button again at the end of the teach event. The characteristic curve with falling curve has been taught.
6. Error-free teach: LED states acc. to table under "Device functions and indicators". Faulty teach: green and yellow LEDs flash at 8Hz until an error-free teach is performed.	6. Error-free teach: LED states acc. to table under "Device functions and indicators". Faulty teach: green and yellow LEDs flash at 8Hz until an error-free teach is performed.

1) See table "Characteristic curve behavior as a function of the object distances for start/end of measurement range"

Adjusting the sensor via the teach input

multi funct connection pin 2 is configured ex works as a teach input. Via the teach input, you can

- lock the control buttons.
- perform a 1-point teach (static) of the switching output.
- perform a 2-point window-teach (static) of the switching output.
- perform a 2-point teach of the characteristic curve of the analog output.



LOW signal level $\leq 0.191 \cdot U_B$ or not connected

Signal level HIGH $\geq 0.809 \cdot U_B$

Locking of the control buttons

Action	Pin 2 (multi funct)	Description
Locking the control buttons	HIGH signal (permanent)	As long as the HIGH signal is continuously applied, the sensor cannot be adjusted with the control buttons. The control buttons of the sensor are disabled.
Unlocking the control buttons	LOW signal or not connected (permanent)	As long as the LOW signal is continuously applied or pin 2 remains unconnected, the sensor can be adjusted with the control buttons.

Teach of switching output and analog output

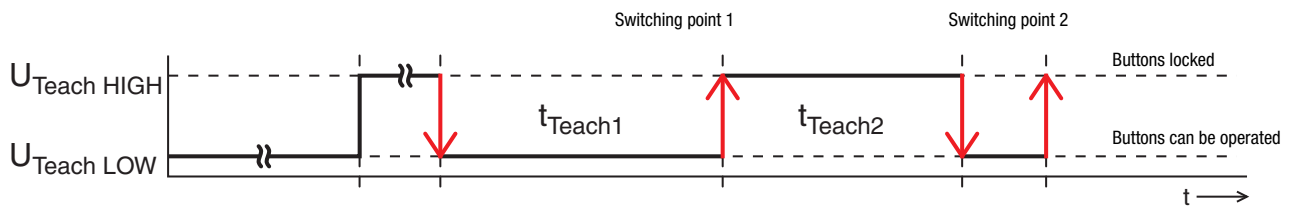

After the delay before start-up ($\leq 300\text{ms}$) has elapsed, the control buttons of the sensor can be operated.

$\geq 20\text{ms}$

Pulse duration t_{Teach1}

Pulse duration t_{Teach2}
20 ... ∞ms

$\geq 20\text{ms}$

<p>Switching output OUT1: $t_{\text{Teach1}} = 20 \dots 80\text{ms}$</p>	<p>1-point teach (static)</p> <p>Place object. The current object distance is taken over as switching point 1 with the rising edge of t_{Teach2}.</p> <p>Do not change the object distance! The falling edge of t_{Teach2} ends the teach event.</p>
<p>Switching output OUT1: $t_{\text{Teach1}} = 120 \dots 180\text{ms}$</p>	<p>2-point window-teach (static)</p> <p>Place object. The current object distance is taken over as switching point 1 with the rising edge of t_{Teach2}.</p> <p>Sensor remains in teach mode. Change the object distance now! The current object distance is taken over as switching point 2 and the teach event is ended with the falling edge of t_{Teach2}.</p>
<p>Analog output OUT2: $t_{\text{Teach1}} = 120 \dots 180\text{ms}$</p>	<p>2-point teach of analog characteristic (static)</p> <p>Place object. The current object distance is taken over as the start point of the measurement range with the rising edge of t_{Teach2}.</p> <p>Sensor remains in teach mode. Change the object distance now! The current object distance is taken over as the end point of the measurement range and the teach event is ended with the falling edge of t_{Teach2}.</p>



Notice!

The procedure is identical for the 2-point window-teach for switching output OUT1 and for the 2-point teach of the characteristic curve of analog output OUT2 via the teach input. The characteristic curve and switching window can only be adjusted independently via the control buttons or the IO-Link interface.

The changeover of the switching function (NC contact/NO contact) and the characteristic curve (rising/falling) is not possible via the teach input.

IO-Link interface

The ultrasonic sensor features an IO-Link interface acc. to specification V1.1. and satisfies the Smart Sensor Profile.

As a result, the sensor can easily, quickly and, thus, economically be configured and diagnostic information read out. With a small amount of effort, the sensor can also be integrated in a control.

Overview of the configuration options via IO-Link

Function block	Function	Description
Operating mode	Standard operation	The sensor operates as a scanner with background suppression.
	Multiplex operation	A max. of 10 sensors – 1 master and 9 slaves – can be wired together in a network. To do this, the sensors must be electrically connected with one line. The master generates a timing signal and all networked sensors are activated with time-delay.
	Synchronous operation	A max. of 10 sensors – 1 master and 9 slaves – can be wired together in a network. To do this, the sensors must be electrically connected with one line. The master generates a timing signal and all networked sensors are activated simultaneously.
	Activation operation	The sensor can be activated through an external signal.
	Operation as throughbeam sensor	The sensor can either be configured as a scanner or as a throughbeam sensor. Operation as a throughbeam sensor requires 2 sensors, which are electrically connected through one line.
Switching output OUT1	Switching point 1/2	The switching points can be directly entered as distance value in mm.
	Switching output (OUT1 and OUT2)	Adjustment as PNP or NPN switching output
	Switching function	Adjustment as NC / NO contact.
	Switching behavior in the case of error	The switching behavior of output OUT1 of the sensor, for objects which are located outside of the scanning range, can be adjusted.
	2-point behavior	If a switching output is to operate with 2 switching points, a choice can be made between 2-point window-teach (factory setting) or 2-point teach (e.g. for simple pump controls with minimum and maximum fill levels).
	Teach switching output OUT1	The switching output OUT1 can be taught via the IO-Link interface.
	Teach lock	Adjustment for locking of control buttons
Analog output OUT2	Analog start value	The distance for the start point of the measurement range can be entered directly in mm.
	Analog end value	The distance for the end point of the measurement range can be entered directly in mm.
	Direction of the characteristic curve	Configuration option for rising or falling characteristic curve.
	Value range	For devices with voltage output: 0 ... 10V (factory setting); 0 ... 5V; 1 ... 6V. For devices with current output: 4 ... 20mA (factory setting); 0 ... 20mA.
Temperature	Temperature compensation	Adjustment option for internal (sensor works with the integrated temperature sensor) or external (with a constant application temperature, this can be manually entered. The sensor then compensates the measured values at a fixed rate with this temperature).
	Unit	Adjustment option to °C or °F.
	Temperature value	Entry temperature value in °C or °F (if external temperature compensation is desired).

In addition to the configuration functions, a range of sensor information, such as sensor status, sensor diagnostics as well as the process data, can be called up.

Further information and the device-specific description of the IO-Link interface (**IODD**) can be found on the Internet at www.leuze.com in the **Downloads** area of the respective sensor.

