

Technical data sheet Light curtain transmitter

Part no.: 50131373

CSL505-T05-355-M8

Contents

- Technical data
- Dimensioned drawings
- Electrical connection
- Operation and display
- Suitable receivers
- Part number code
- Accessories



Figure can vary



Technical data

Basic data

Series	505
Operating principle	Throughbeam principle
Device type	Transmitter
Application	Precise object detection

Special version

Special version	Crossed-beam scanning
	Diagonal-beam scanning
	Parallel-beam scanning

Optical data

Operating range	Guaranteed operating range
Operating range	0.3 ... 5 m
Measurement field length	355 mm
Number of beams	72 Piece(s)
Beam spacing	5 mm
Light source	LED, Infrared
Wavelength	860 nm

Measurement data

Minimum object diameter	7.5 mm
-------------------------	--------

Electrical data

Protective circuit	Inductive protection
	Polarity reversal protection
	Short circuit protected

Performance data

Supply voltage U_B	18 ... 30 V, DC
----------------------	-----------------

Connection

Number of connections	1 Piece(s)
-----------------------	------------

Connection 1

Function	Deactivation input
	Voltage supply
Type of connection	Connector
Thread size	M8
Type	Male
Material	Metal
No. of pins	4 -pin
Encoding	A-coded

Mechanical data

Design	Cubic
Dimension (W x H x L)	12 mm x 440 mm x 58 mm
Housing material	Metal
Metal housing	Aluminum
Lens cover material	Plastic
Housing color	Silver
Type of fastening	Through-hole mounting

Operation and display

Type of display	LED
Number of LEDs	1 Piece(s)
Type of configuration	Software
	Via pin assignment

Environmental data

Ambient temperature, operation	-30 ... 50 °C
Ambient temperature, storage	-40 ... 65 °C

Certifications

Degree of protection	IP 65
Protection class	III

Classification

Customs tariff number	90314990
ECLASS 5.1.4	27270910
ECLASS 8.0	27270910
ECLASS 9.0	27270910
ECLASS 10.0	27270910
ECLASS 11.0	27270910
ECLASS 12.0	27270910
ECLASS 13.0	27270910
ETIM 5.0	EC002549
ETIM 6.0	EC002549
ETIM 7.0	EC002549
ETIM 8.0	EC002549

Dimensioned drawings

All dimensions in millimeters

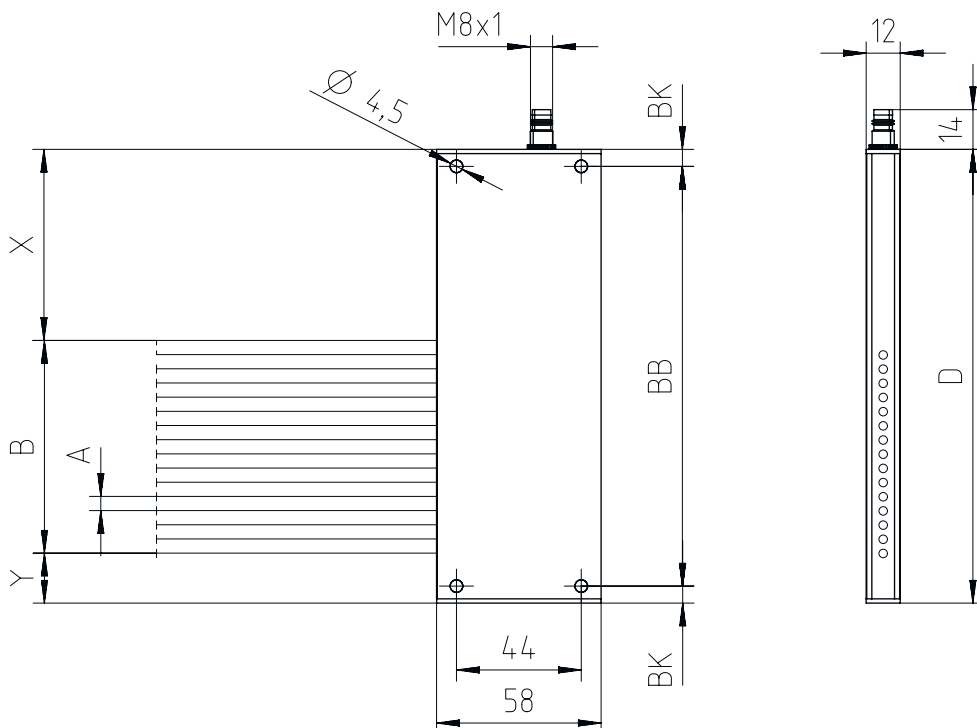

Electrical connection

Connection 1

Function	Deactivation input
	Voltage supply
Type of connection	Connector
Thread size	M8
Type	Male
Material	Metal
No. of pins	4 -pin
Encoding	A-coded

Pin	Pin assignment
1	V+
2	n.c.
3	GND
4	IN 1

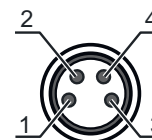

Operation and display

LED	Display	Meaning
1	Off	Off
	Red, continuous light	Operational readiness
	Red, flashing	Error

Suitable receivers

Part no.	Designation	Article	Description
50131316	CSL505-R05-355-M8	Light curtain receiver	Application: Precise object detection Special version: Parallel-beam scanning, Crossed-beam scanning, Diagonal-beam scanning, Teach input, Warning output Operating range: 0.3 ... 5 m Digital switching outputs: 2 Piece(s) Switching output: Transistor, Push-pull, Light/dark reversible Connection: Connector, M8, 4 -pin

Part number code

Part designation: **CSL505-YYYY-ZZZZ-AA-BBB**

X	Operating principle T: transmitter R: receiver
YYY	Beam spacing 05: 5 mm 12.5: 12.5 mm 25: 25 mm 50: 50 mm 100: 100 mm
ZZZZ	Measurement field length Measurement field length [mm], dependent on beam spacing
AA	Electrical connection M8: M8 connector, 4-pin (plug)

Note



A list with all available device types can be found on the Leuze website at www.leuze.com.

Accessories

Connection technology - Connection cables

Part no.	Designation	Article	Description
50130850	KD U-M8-4A-V1-050	Connection cable	Connection 1: Connector, M8, Axial, Female, 4 -pin Connector, LED: No Connection 2: Open end Shielded: No Cable length: 5.000 mm Sheathing material: PVC
50130871	KD U-M8-4W-V1-050	Connection cable	Connection 1: Connector, M8, Angled, Female, 4 -pin Connector, LED: No Connection 2: Open end Shielded: No Cable length: 5.000 mm Sheathing material: PVC

Configuration devices

Part no.	Designation	Article	Description
50132069	CSL505-Interface	Module	Functions: Configuration and test device Connection: Sub-D

Accessories

Note



🔗 A list with all available accessories can be found on the Leuze website in the Download tab of the article detailed page.