

Technical data sheet Energetic diffuse sensor

Part no.: 50140139

ET412B.1/NX-M12

Contents

- Technical data
- Dimensioned drawings
- Electrical connection
- Diagrams
- Operation and display
- Part number code
- Notes
- Accessories



Figure can vary



Technical data

Basic data

Series	412B
Operating principle	Diffuse reflection principle

Optical data

Operating range	Guaranteed operating range
Operating range, white 90%	0.004 ... 0.54 m
Operating range, gray 50%	0.007 ... 0.46 m
Operating range, gray 18%	0.008 ... 0.3 m
Operating range, black 6%	0.01 ... 0.22 m
Operating range limit	Typical operating range
Operating range limit, white 90%	0.004 ... 0.66 m
Operating range limit, gray 50%	0.007 ... 0.57 m
Operating range limit, gray 18%	0.008 ... 0.37 m
Operating range limit, black 6%	0.01 ... 0.285 m
Light source	LED, Red
Wavelength	660 nm
Transmitted-signal shape	Pulsed
LED group	Exempt group (in acc. with EN 62471)

Electrical data

Protective circuit	Polarity reversal protection Short circuit protected
--------------------	---------------------------------------------------------

Performance data

Supply voltage U_B	10 ... 36 V, DC, Incl. residual ripple
Residual ripple	0 ... 20 %, From U_B
Open-circuit current	0 ... 15 mA

Outputs

Number of digital switching outputs	1 Piece(s)
-------------------------------------	------------

Switching outputs

Voltage type	DC
Switching current, max.	200 mA

Switching output 1

Switching element	Transistor, NPN
Switching principle	Dark switching

Time behavior

Switching frequency	1,000 Hz
Response time	0.5 ms
Readiness delay	60 ms

Connection

Connection 1

Function	Signal OUT Voltage supply
Type of connection	Connector
Thread size	M12
Type	Male
Material	Metal
No. of pins	4 -pin
Encoding	A-coded

Mechanical data

Thread size	M12 x 1 mm
Dimension (Ø x L)	12 mm x 60 mm
Housing material	Metal
Metal housing	Chromed brass
Lens cover material	Glass
Net weight	20 g
Housing color	Silver

Operation and display

Type of display	LED
Number of LEDs	3 Piece(s)
Operational controls	270° potentiometer
Function of the operational control	Sensitivity adjustment

Environmental data

Ambient temperature, operation	-25 ... 55 °C
--------------------------------	---------------

Certifications

Degree of protection	IP 67
Protection class	III
Certifications	c UL US
Standards applied	IEC 60947-5-2

Classification

Customs tariff number	85365019
ECLASS 5.1.4	27270903
ECLASS 8.0	27270903
ECLASS 9.0	27270903
ECLASS 10.0	27270903
ECLASS 11.0	27270903
ECLASS 12.0	27270903
ECLASS 13.0	27270903
ETIM 5.0	EC001821
ETIM 6.0	EC001821
ETIM 7.0	EC001821
ETIM 8.0	EC001821

Dimensioned drawings

All dimensions in millimeters

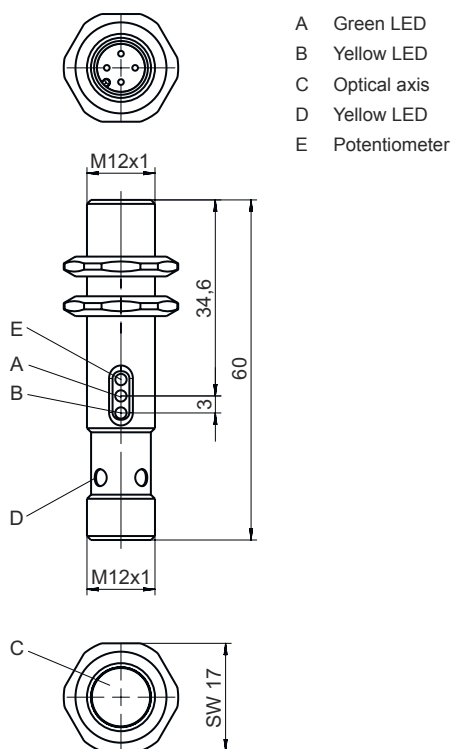

Electrical connection

Connection 1

Function	Signal OUT Voltage supply
Type of connection	Connector
Thread size	M12
Type	Male
Material	Metal
No. of pins	4 -pin
Encoding	A-coded

Pin	Pin assignment
1	V+
2	OUT 1
3	GND
4	n.c.

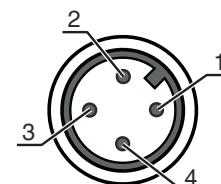

Diagrams

Typ. black/white behavior

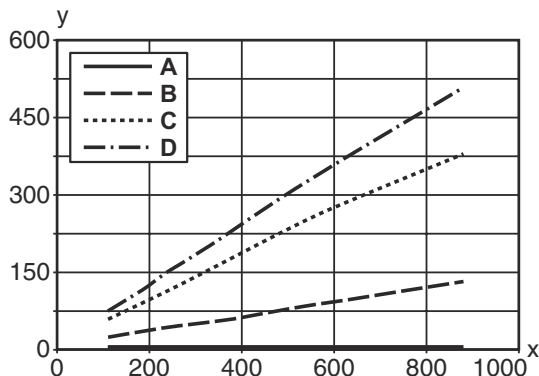

x Range [mm]
 y Reduction of range [mm]
 A White 90%
 B Gray 50%
 C Gray 18%
 D Black 6%

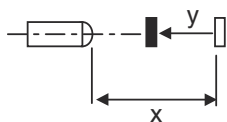

Operation and display

LED	Display	Meaning
1	Green, continuous light	Function reserve
2	Yellow, continuous light	Switching output/switching state active

Part number code

Part designation: AAA412BGG.H/ii-K

AAA412B	Operating principle / construction LS412B: Throughbeam photoelectric sensor transmitter LE412B: Throughbeam photoelectric sensor receiver ET412B: Energetic diffuse reflection sensor PRK412B: Retro-reflective photoelectric sensor with polarization filter
GG	Light source n/a: LED L2: laser class 2
H	Operating range adjustment 1: 270° potentiometer
ii	Switching output / function / OUT1OUT2 (OUT1 = pin 2, OUT2 = pin 4) 2: NPN transistor output, light switching N: NPN transistor output, dark switching 4: PNP transistor output, light switching P: PNP transistor output, dark switching D: Deactivation input (deactivation with low signal) X: pin not used
K	Electrical connection n/a: cable, standard length 2000 mm, 3-wire M12: M12 connector, 4-pin (plug)

Note



A list with all available device types can be found on the Leuze website at www.leuze.com.

Notes





Observe intended use!



- ⌘ This product is not a safety sensor and is not intended as personnel protection.
- ⌘ The product may only be put into operation by competent persons.
- ⌘ Only use the product in accordance with its intended use.

Accessories

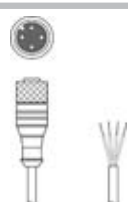
Connection technology - Connection cables

	Part no.	Designation	Article	Description
	50130652	KD U-M12-4A-V1-050	Connection cable	Connection 1: Connector, M12, Axial, Female, A-coded, 4 -pin Connector, LED: No Connection 2: Open end Shielded: No Cable length: 5.000 mm Sheathing material: PVC
	50130690	KD U-M12-4W-V1-050	Connection cable	Connection 1: Connector, M12, Angled, Female, A-coded, 4 -pin Connector, LED: No Connection 2: Open end Shielded: No Cable length: 5.000 mm Sheathing material: PVC

Mounting technology - Mounting brackets

	Part no.	Designation	Article	Description
	50113549	BT D12M.5	Mounting bracket	Diameter, inner: 12 mm Design of mounting device: Angle, L-shape Fastening, at system: Through-hole mounting Mounting bracket, at device: Screw type Type of mounting device: Rigid Material: Stainless steel

Note



- ⌘ A list with all available accessories can be found on the Leuze website in the Download tab of the article detailed page.