

## Technical data sheet Energetic diffuse sensor

Part no.: 50133942

FT328I.X3/4P-M12

### Contents

- Technical data
- Dimensioned drawings
- Electrical connection
- Diagrams
- Operation and display
- Part number code
- Notes
- Further information
- Accessories



Figure can vary



## Technical data

### Basic data

Series	328
Operating principle	Diffuse reflection principle
Application	Detection of dark objects at short range

### Special version

Special version	V-optics
-----------------	----------

### Optical data

Operating range	Guaranteed operating range
Operating range, white 90%	0.001 ... 0.11 m
Operating range, gray 50%	0.001 ... 0.1 m
Operating range, gray 18%	0.003 ... 0.08 m
Operating range, black 6%	0.005 ... 0.07 m
Operating range limit	Typical operating range
Operating range limit, white 90%	0.001 ... 0.13 m
Operating range limit, gray 50%	0.001 ... 0.12 m
Operating range limit, gray 18%	0.003 ... 0.1 m
Operating range limit, black 6%	0.005 ... 0.085 m
Light source	LED, Infrared
Wavelength	850 nm
Transmitted-signal shape	Pulsed
LED group	Exempt group (in acc. with EN 62471)

### Electrical data

Protective circuit	Polarity reversal protection Short circuit protected
--------------------	---------------------------------------------------------

### Performance data

Supply voltage $U_B$	10 ... 30 V, DC, Incl. residual ripple
Residual ripple	0 ... 15 %, From $U_B$
Open-circuit current	0 ... 20 mA

### Outputs

Number of digital switching outputs	2 Piece(s)
-------------------------------------	------------

### Switching outputs

Voltage type	DC
Switching current, max.	100 mA
Switching voltage	high: $\geq(U_B - 2.5V)$ low: $\leq 2.5 V$

### Switching output 1

Assignment	Connection 1, pin 4
Switching element	Transistor, PNP
Switching principle	Light switching

### Switching output 2

Assignment	Connection 1, pin 2
Switching element	Transistor, PNP
Switching principle	Dark switching

### Time behavior

Switching frequency	500 Hz
Response time	1 ms
Readiness delay	300 ms

### Connection 1

Function	Signal OUT Voltage supply
Type of connection	Connector
Thread size	M12
Type	Male
Material	Plastic
No. of pins	4 -pin
Encoding	A-coded

### Mechanical data

Thread size	M18 x 1 mm
Dimension ( $\varnothing$ x L)	18 mm x 46 mm
Housing material	Plastic Stainless steel
Stainless steel housing	V2A
Plastic housing	ABS
Lens cover material	Plastic
Net weight	70 g
Housing color	Black Red

### Operation and display

Type of display	LED
Number of LEDs	2 Piece(s)
Operational controls	Teach button

### Environmental data

Ambient temperature, operation	-40 ... 60 °C
Ambient temperature, storage	-40 ... 70 °C

### Certifications

Degree of protection	IP 67
Protection class	III
Certifications	c UL US
Standards applied	IEC 60947-5-2

### Classification

Customs tariff number	85365019
ECLASS 5.1.4	27270903
ECLASS 8.0	27270903
ECLASS 9.0	27270903
ECLASS 10.0	27270903
ECLASS 11.0	27270903
ECLASS 12.0	27270903
ECLASS 13.0	27270903
ETIM 5.0	EC001821
ETIM 6.0	EC001821
ETIM 7.0	EC001821
ETIM 8.0	EC001821

# Dimensioned drawings

All dimensions in millimeters

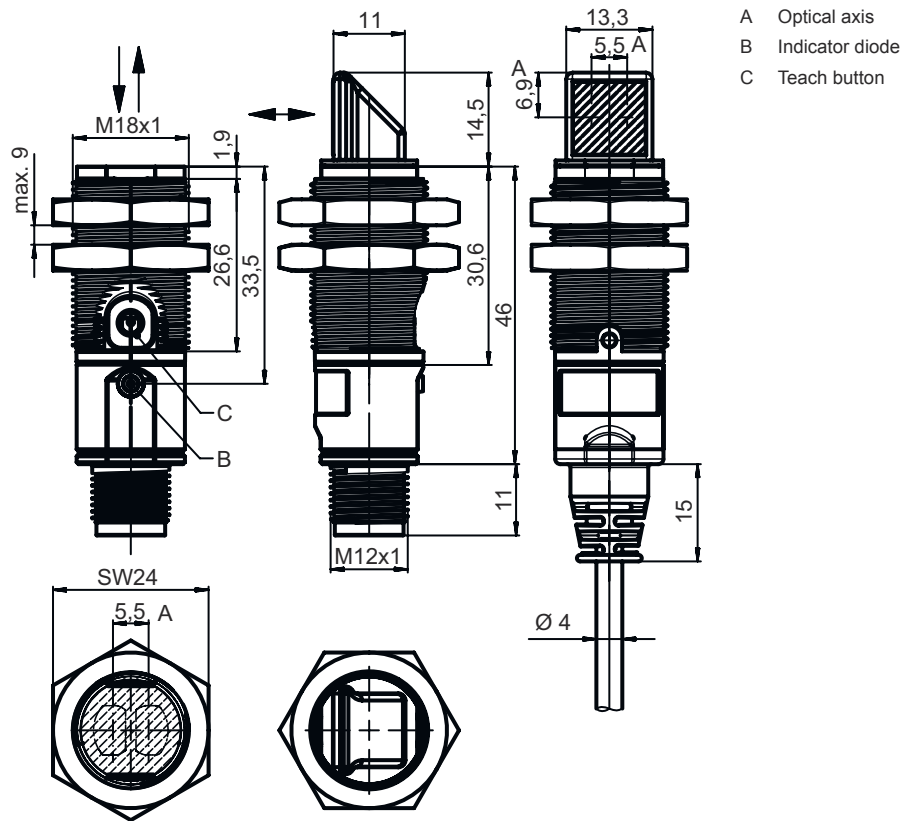

- A Optical axis
- B Indicator diode
- C Teach button

## Electrical connection

### Connection 1

Function	Signal OUT Voltage supply
Type of connection	Connector
Thread size	M12
Type	Male
Material	Plastic
No. of pins	4 -pin
Encoding	A-coded

### Pin Pin assignment

Pin	Pin assignment
1	V+
2	OUT 2
3	GND
4	OUT 1

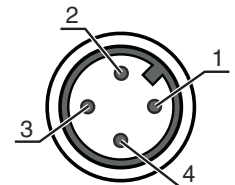

# Diagrams

## Typ. black/white behavior

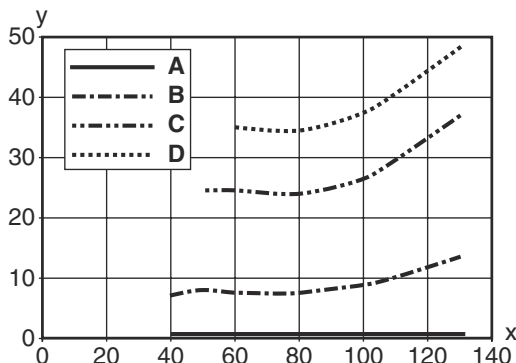

x Range [mm]  
y Reduction of range [mm]

- A White 90%
- B Gray 50%
- C Gray 18%
- D Black 6%

**Fading: black/white error < 50 %**

The black/white error is calculated from the operating range against white and the reduction of the operating range against black:

$$\text{black/white error} = \frac{\text{reduction of the operating range against black}}{\text{operating range against white}} \times 100\%$$

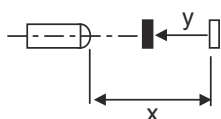

## Operation and display

LED	Display	Meaning
1	Green, continuous light	Operational readiness
	Yellow, continuous light	Object detected

## Part number code

Part designation: **XXX328BY-AAAF.BB/CC-DDD**

<b>XXX328</b>	<p><b>Operating principle</b>                      PRK: Retro-reflective photoelectric sensor with polarization filter                      ET: energetic diffuse reflection sensor                      FT: diffuse reflection sensor with fading                      LE: Throughbeam photoelectric sensor receiver                      LS: throughbeam photoelectric sensor transmitter</p>
<b>Y</b>	<p><b>Light type</b>                      n/a: red light                      I: infrared light</p>
<b>BB</b>	<p><b>Equipment</b>                      n/a: axial optics                      W: 90° angular optics                      3: teach-in via button                      X: reinforced fading</p>

## Part number code

<b>CC</b>	<b>Switching output / function (OUT1 = pin 4, OUT2 = pin 2):</b> 4: PNP transistor output, light switching P: PNP transistor output, dark switching 2: NPN transistor output, light switching N: NPN transistor output, dark switching 9: input for transmitter deactivation (deactivation with HIGH signal) D: Input for transmitter deactivation (deactivation with LOW signal) X: pin not used
<b>DDD</b>	<b>Electrical connection</b> n/a: cable, standard length 2000 mm, 4-wire M12: M12 connector, 4-pin (plug)

### Note

	↪ A list with all available device types can be found on the Leuze website at <a href="http://www.leuze.com">www.leuze.com</a> .
----------------------------------------------------------------------------------	----------------------------------------------------------------------------------------------------------------------------------

## Notes

### Observe intended use!

	<ul style="list-style-type: none"> <li>↪ This product is not a safety sensor and is not intended as personnel protection.</li> <li>↪ The product may only be put into operation by competent persons.</li> <li>↪ Only use the product in accordance with its intended use.</li> </ul>
-----------------------------------------------------------------------------------	---------------------------------------------------------------------------------------------------------------------------------------------------------------------------------------------------------------------------------------------------------------------------------------

### For UL applications:



	<ul style="list-style-type: none"> <li>↪ For UL applications, use is only permitted in Class 2 circuits in accordance with the NEC (National Electric Code).</li> <li>↪ These proximity switches shall be used with UL Listed Cable assemblies rated 30V, 0.5A min, in the field installation, or equivalent (categories: CYJV/ CYJV7 or PVVA/PVVA7)</li> </ul>
------------------------------------------------------------------------------------	-----------------------------------------------------------------------------------------------------------------------------------------------------------------------------------------------------------------------------------------------------------------------------------------------------------------------------------------------------------------

## Further information

- Sum of the output currents for both outputs, 50 mA for ambient temperatures > 40 °C
- With the set scanning range, a tolerance of the operating range is possible depending on the reflection properties of the material surface.

## Accessories

### Connection technology - Connection cables

	Part no.	Designation	Article	Description
  	50130652	KD U-M12-4A-V1-050	Connection cable	Connection 1: Connector, M12, Axial, Female, A-coded, 4 -pin Connector, LED: No Connection 2: Open end Shielded: No Cable length: 5.000 mm Sheathing material: PVC

## Accessories

	Part no.	Designation	Article	Description
	50130690	KD U-M12-4W-V1-050	Connection cable	Connection 1: Connector, M12, Angled, Female, A-coded, 4 -pin Connector, LED: No Connection 2: Open end Shielded: No Cable length: 5.000 mm Sheathing material: PVC

## Mounting technology - Mounting brackets

	Part no.	Designation	Article	Description
	50113548	BT D18M.5	Mounting bracket	Diameter, inner: 18 mm Design of mounting device: Angle, L-shape Fastening, at system: Through-hole mounting Mounting bracket, at device: Screw type Type of mounting device: Rigid Material: Stainless steel

## Mounting technology - Rod mounts

	Part no.	Designation	Article	Description
	50117490	BTU D18M-D12	Mounting system	Design of mounting device: Mounting system Fastening, at system: Through-hole mounting Mounting bracket, at device: Screw type Type of mounting device: Clampable, Adjustable, Turning, 360° Material: Metal

## Mounting technology - Other

	Part no.	Designation	Article	Description
	50126631	BT 328M	Fastening	Design of mounting device: Mounting clamp Fastening, at system: For 18 mm rod, Through-hole mounting Mounting bracket, at device: Screw type Type of mounting device: Turning, 360° Material: Stainless steel Shock absorber: No

### Note



A list with all available accessories can be found on the Leuze website in the Download tab of the article detailed page.