

HRTR 53

Diffuse reflection light scanner with background suppression

en 05-2017/11 50107826-01



5 ... 400mm
200mm with
black-white error < 10%



- Diffuse reflection light scanner with visible red light and adjustable background suppression
- 316L stainless steel housing in Hygiene-Design
- Enclosed optics design prevents bacterial carry-overs
- ECOLAB and CleanProof+ tested
- Paperless device identification
- Scratch resistant and non-diffusive plastic front cover
- Exact scanning range adjustment through 8-turn potentiometer
- Very good black/white behavior and reliable switching nearly independent of the object or background properties
- Fast alignment through *brightVision*®
- A²LS- Active Ambient Light Suppression
- Push-pull switching outputs
- High switching frequency for detection of fast events

Accessories:

(available separately)

- Mounting systems (BT 3...)
- Cables with M8 or M12 connector (KD ...)
- Mounting devices

Dimensioned drawing

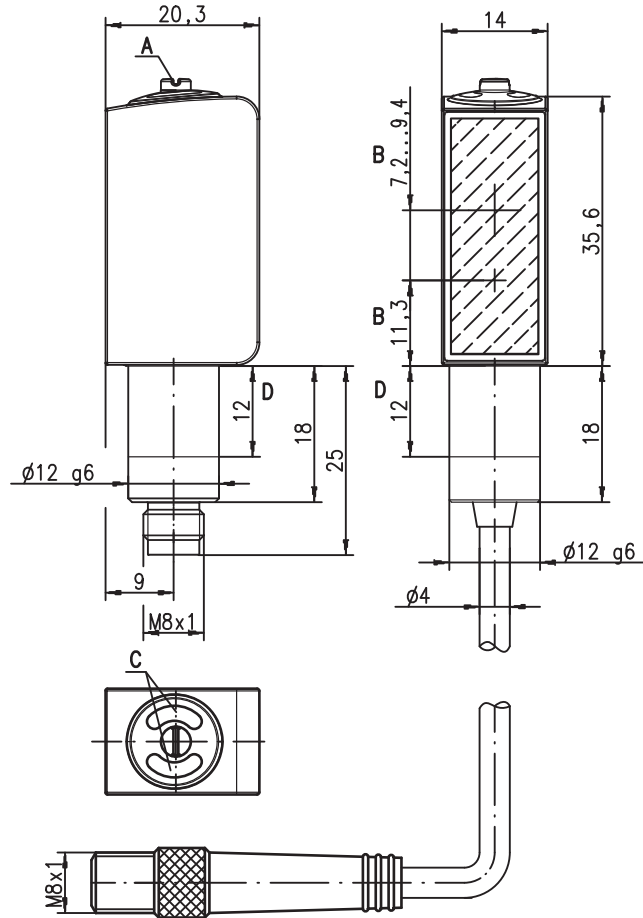

- A** Adjustment screw
- B** Optical axis
- C** Indicator diodes
- D** Permissible clamping range

Electrical connection

Plug connection, 4-pin (with/without cable)

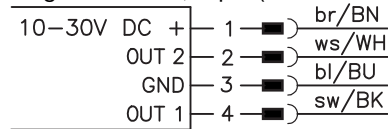

Connector, 3-pin

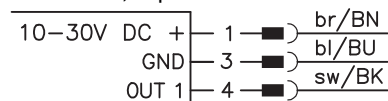

Cable, 4 wires

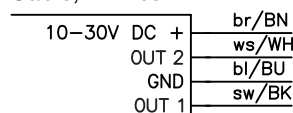

We reserve the right to make changes • DS_HRTR53_en_50107826_01.fm

Specifications

Optical data

Typ. scanning range limit ¹⁾	5 ... 400mm
Scanning range ²⁾	see tables
Adjustment range	15 ... 400mm
Light beam characteristic	focussed at 200mm
Light source ³⁾	LED (modulated light)
Wavelength	620nm (visible red light)

Timing

Switching frequency	1000Hz
Response time	0.5ms
Delay before start-up	≤ 300ms (acc. to. IEC 60947-5-2)

Electrical data

Operating voltage U_B ⁴⁾	10 ... 30VDC (incl. residual ripple)
Residual ripple	≤ 15% of U_B
Open-circuit current	≤ 15mA
Switching output	.../66 ⁵⁾ 2 push-pull switching outputs pin 2: PNP dark switching, NPN light switching pin 4: PNP light switching, NPN dark switching .../6 ⁵⁾ 1 push-pull switching output pin 4: PNP light switching, NPN dark switching light/dark switching
Function characteristics	≥ ($U_B - 2V$)/≤ 2V
Signal voltage high/low	max. 100mA
Output current	adjustable via 8-turn potentiometer
Scanning range	

Indicators

LED green	ready
Yellow LED	object detected - reflection

Mechanical data

Housing	AISI 316L stainless steel, DIN X2CrNiMo17132, W.No1.4404
Housing design	HYGIENE-Design
Housing roughness ⁶⁾	$R_a \leq 2.5$
Connector	AISI 316L stainless steel, DIN X2CrNiMo17132, W.No1.4404
Optics cover	coated plastic (PMMA), scratch resistant and non-diffusive
Operation	plastic (TPV-PE), non-diffusive
Weight	with M8 connector: 50g with 200mm cable and M8 connector: 60g with 5000mm cable: 110g
Connection type	M8 connector, 4-pin or 3-pin, 0.2m cable with M8 connector, 4-pin, 5m cable, 4 x 0.20mm ² via fit (see "Remarks")
Fastening	3 Nm (permissible range, see dimensioned drawing)
Max. tightening torque	

Environmental data

Ambient temp. (operation/storage) ⁷⁾	-30°C ... +70°C / -30°C ... +70°C
Protective circuit ⁸⁾	2, 3
VDE safety class ⁹⁾	III
Protection class	IP 67, IP 69K ¹⁰⁾
Environmentally tested acc. to	ECOLAB, CleanProof+
Light source	exempt group (in acc. with EN 62471)
Standards applied	IEC 60947-5-2
Certifications	UL 508, C22.2 No.14-13 ^{4) 7) 11)}
Chemical resistance	tested in accordance with ECOLAB and CleanProof+ (see Remarks)

- 1) Typ. scan. range limit: max. achievable scanning range for light objects (white 90%)
- 2) Scanning range: recommended scanning range for objects with different diffuse reflection
- 3) Average life expectancy 100,000h at an ambient temperature of 25°C
- 4) For UL applications: for use in class 2 circuits according to NEC only
- 5) The push-pull switching outputs must not be connected in parallel.
- 6) Typical value for the stainless steel housing
- 7) UL certification for a temperature range of -30°C to +55°C, operating temperatures of +70°C permissible only briefly (≤ 15min)
- 8) 2=polarity reversal protection, 3=short circuit protection for all transistor outputs
- 9) Rating voltage 50V
- 10) Only with internal tube mounting of the M8 connector
- 11) These proximity switches shall be used with UL Listed Cable assemblies rated 30V, 0.24A min, in the field installation

Tables

1	5	400
2	10	300
3	15	200

1	white 90%
2	gray 18%
3	black 6%

Scanning range [mm]

Diagrams

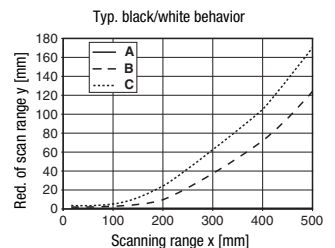
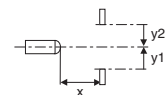
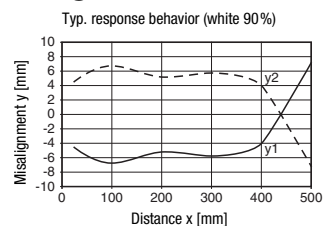

- A white 90%
- B gray 18%
- C black 6%

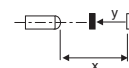

Remarks

Operate in accordance with intended use!

- ⚠ This product is not a safety sensor and is not intended as personnel protection.
- ⚠ The product may only be put into operation by competent persons.
- ⚠ Only use the product in accordance with the intended use.

- A list of tested chemicals can be found in the first part of the product description.
- Only secure in designated area using set screw.
Max. tightening torque 3Nm.

UL REQUIREMENTS

Enclosure Type Rating: Type 1

For Use in NFPA 79 Applications only.

Adapters providing field wiring means are available from the manufacturer. Refer to manufacturers information.

CAUTION – the use of controls or adjustments or performance of procedures other than those specified herein may result in hazardous radiation exposure.

ATTENTION ! Si d'autres dispositifs d'alignement que ceux préconisés ici sont utilisés ou s'il est procédé autrement qu'indiqué, cela peut entraîner une exposition à des rayonnements et un danger pour les personnes.

HRTR 53
Diffuse reflection light scanner with background suppression
Order guide

Selection table		Order code →	HRTR 53/66-S8 Part No. 50107499	HRTR 53/6-S8.3 Part No. 50107500	HRTR 53/66.200-S8 Part No. 50107501	HRTR 53/66.5000 Part no. 50121900
Equipment ↓						
Switching output	2 x push-pull switching output		●		●	●
	1 x push-pull switching output			●		
Switching function	1 PNP light switching and NPN dark switching output		●	●	●	●
	1 PNP dark switching and NPN light switching output		●		●	●
Connection	M8 connector, metal, 4-pin		●			
	M8 connector, metal, 3-pin			●		
	cable 200 mm with M 8 connector, 4-pin				●	
	cable 5000 mm, 4-wire					●
Indicators	green LED: ready		●	●	●	●
	yellow LED: switching output		●	●	●	●

Application notes

- For glossy surfaces (e.g. metals), the light beam should not be incident on the object surface at a right angle. A slight inclination is sufficient for preventing undesired direct reflections. This may result in a reduction in the scanning range.
- Objects should only be moved in laterally from the right or left. Moving in objects from the connector side or operating side is to be avoided.
- Outside of the scanning range, the sensor operates as an energetic diffuse reflection light scanner. Light objects can still be reliably detected up to the scanning range limit.
- The sensors are equipped with effective measures for the maximum avoidance of mutual interference should they be mounted opposite one another. Opposite mounting of multiple sensors of the same type should, however, absolutely be avoided.

