

HT10

Laser diffuse sensors with background suppression

en 2021/03/12 50130292-03



50 ... 8000mm

- Laser diffuse sensor with large detection range for universal application (visible red light)
- Light propagation time measurement makes use possible under extreme environmental conditions (brightness, light, interfering contours)
- Extremely simple operation, teachable switching points
- Minimum teach duration prevents unintentional changing of the switching points
- Preset hysteresis and reserve ensure reliable switching behavior
- Switching behavior independent of the entry direction
- Optimized for positioning applications and reliable object detection (e.g. compartment occupation check, shelf positioning)

Dimensioned drawing

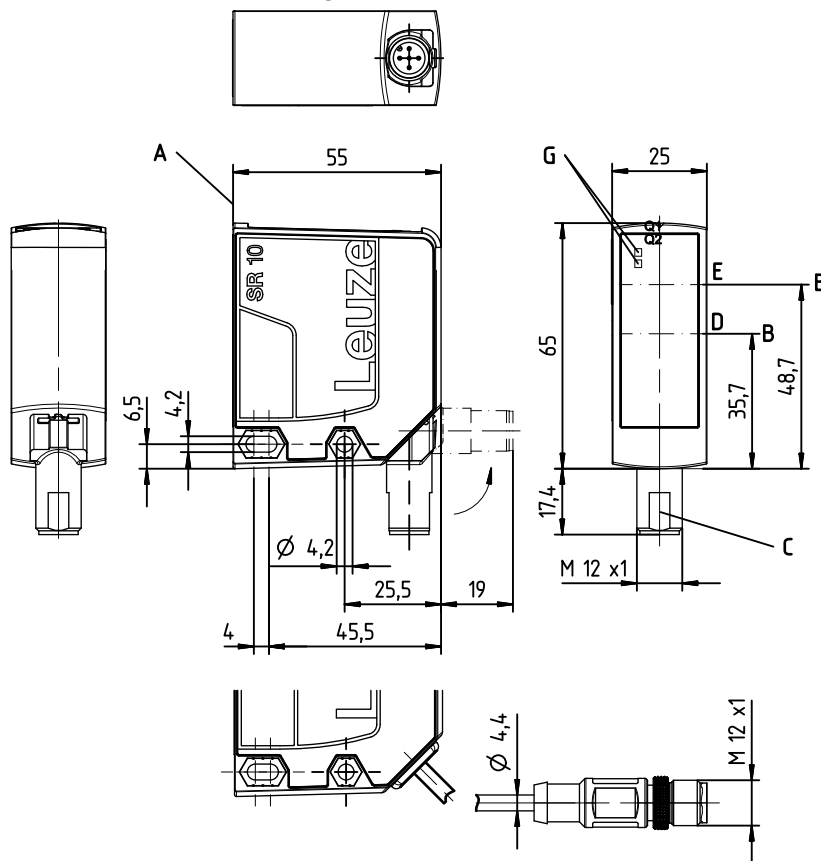

- A Reference edge for the measurement
- B Optical axis
- C Turning M12 connector, 90°
- D Receiver
- E Transmitter
- G Indicator diodes green/red (control panel)
2 x yellow (control panel and lens cover)
- H Membrane keyboard

Electrical connection

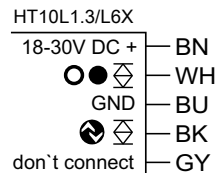
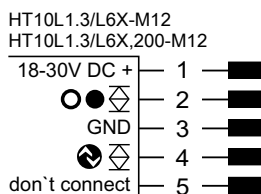
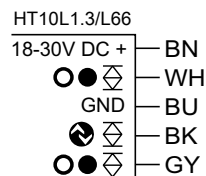
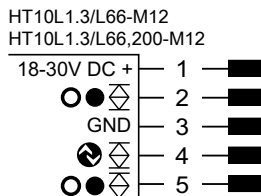
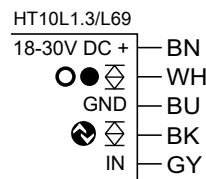
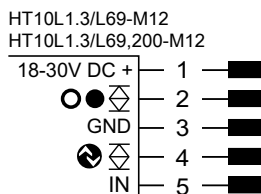

Accessories:

(available separately)

- Mounting systems
- Cable with M12 connector (K-D ...)
- IO-Link master set
SET MD12-US2-IL1.1 + accessories - diagnostics set (part no. 50121098)

We reserve the right to make changes • DS_HT10_en_50130292_03.fm

Technical data

Optical data

Typ. maximum range (white 90%) ¹⁾	50 ... 8000mm
Operating range ²⁾	50 ... 3500mm
Adjustment range (teach-in range)	50 ... 8000/3500mm (90%/6% diffuse reflection)
Light source	Laser
Laser class	1 (in acc. with IEC 60825-1:2014)
Wavelength	658nm (visible red light)
Impulse duration	6ns
Max. output power (peak)	391mW
Light spot	Approx. 7x7mm ² at 7m

Error limits

Accuracy ³⁾	± 30mm
B/W detection thresh. (6 ... 90% rem.)	± 10mm
Temperature drift	± 2mm/K

Time behavior

Switching frequency	40Hz
Response time	< 50ms
Readiness delay	≤ 300ms

Electrical data

Operating voltage U _B ⁴⁾	18 ... 30VDC (incl. residual ripple)
Residual ripple	≤ 15% of U _B
Open-circuit current	≤ 150mA
Switching output	.../...6... Push-pull switching output ⁵⁾ , PNP light switching, NPN dark switching
Signal voltage high/low	≥ (U _B -2 V)/≤ 2V
IO-Link	COM2 (38.4kBaud), vers. 1.1, min. cycle time 2.3ms, SIO is supported

Indicators

Green/red LED	Green continuous light	Ready
	Red	No signal
	Orange	Warning, weak signal
	Off	No voltage
Yellow LEDs Q1/Q2	On	Object detected
	Off	Object not detected

Mechanical data

Housing	Plastic
Optics cover	Glass
Weight	70g (M 12 connector) 133g (2m cable) 90g (cable with M 12 connector)
Connection type	Turning M12 connector, 90° 2m cable, wire cross section 5 x 0.14mm ² (5 x 26 AWG) 0.2m cable with M12 connector

Environmental data

Ambient temp. (operation/storage)	-40 °C ... +50 °C/-40 °C ... +70 °C
Protective circuit ⁶⁾	1, 2, 3
VDE protection class	III
Degree of protection	IP 67
Standards applied	IEC 60947-5-2
Certifications	UL 508, CSA C22.2 No.14-13 ^{4) 7)}

Additional functions

Deactivation input

Transmitter inactive/active	≥ 8V/≤ 2V ⁸⁾
Activation/disable delay	≥ 20ms
Input resistance	Approx. 10kΩ

- 1) Typ. maximum range: guaranteed operating range against 90% at maximum setting
- 2) Operating range: recommended range with function reserve
- 3) for measurement range 50 ... 3500mm, diffuse reflection 6% ... 90%, "Speed" operating mode, at 20 °C after 20min. warmup time, medium range of U_B, measurement object ≥ 50x50mm²
- 4) For UL applications: use is permitted exclusively in Class 2 circuits according to NEC
- 5) The push-pull switching outputs must not be connected in parallel
- 6) 1=transient protection, 2=polarity reversal protection, 3=short circuit protection for all outputs
- 7) These proximity switches shall be used with UL Listed Cable assemblies rated 30V, 0.5A min, in the field installation, or equivalent (categories: CYJV/CYJV7 or PVVA/PVVA7)
- 8) Upon deactivation of the laser, the outputs become inactive

Notes

- You can download the IO Device Description (IODD file) and the *Sensor Studio* configuration software (requires IO-Link USB master) from the Internet at www.leuze.com.

Tables

Switching points ¹⁾	No reflection	Object detected
Yellow LED Q 1	Off	On
Yellow LED Q 2	Off	On

1) Applies for object teach

Diagrams

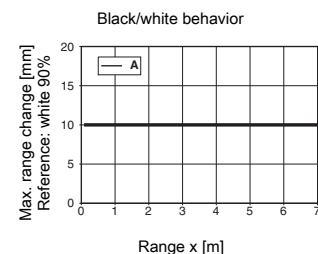

A 6 ... 90% diffuse reflection

Notes

Adjusting the switching points

- **Object teach:**
Align sensor with object.
Q1: Press teach button 1 for approx. 2s,
Q2: Press teach button 2 for approx. 2s,
Q3: Press teach buttons 1+2 for approx. 2s.
Switching point is taught.
Object is detected if the respective Q1/Q2 indicator illuminates. No LED present for Q3.
- **Teach against background:**
Point sensor at background.
Q1: Press teach button 1 for approx. 7s,
Q2: Press teach button 2 for approx. 7s,
Q3: Press teach buttons 1+2 for approx. 7s.
Switching point is taught.
Objects between sensor and background are detected.
- **Hysteresis:**
three selectable hysteresis settings (switchable via IO-Link):
Coarse: 50mm (default)
Medium: 25mm
Fine: 12mm
- **Factory setting:**
hysteresis: approx. 50mm
- With the set detection range, a tolerance of the upper scanning range limit is possible depending on the reflection properties of the material surface.
- Range/reflectivity:

Object/diffuse reflection	
6%	0.05 ... 3.5m
90%	0.05 ... 8m

Observe intended use!

- ↪ This product is not a safety sensor and is not intended as personnel protection.
- ↪ The product may only be put into operation by competent persons.
- ↪ Only use the product in accordance with its intended use.

Laser safety notices

⚠ ATTENTION, LASER RADIATION – CLASS 1 LASER PRODUCT	
	<p>The device satisfies the requirements of IEC/EN 60825-1:2014 safety regulations for a product of laser class 1 and complies with 21 CFR 1040.10 except for conformance with IEC 60825-1 Ed. 3., as described in Laser Notice No. 56, dated May 8, 2019.</p> <ul style="list-style-type: none"> ⚡ Observe the applicable statutory and local laser protection regulations. ⚡ The device must not be tampered with and must not be changed in any way. <p>There are no user-serviceable parts inside the device. Repairs must only be performed by Leuze electronic GmbH + Co. KG.</p>

IO-Link process data format

(IO-Link 1.1, M-sequence TYPE_2_1)

Output data device (8 bit)

Data bit								Assignment	Meaning
7	6	5	4	3	2	1	0		
								Switching output Q1	0 = inactive, 1 = active
								Switching output Q2	0 = inactive, 1 = active
								Switching output Q3	0 = inactive, 1 = active (if Q3 not present = 0)
								Measurement	0 = initialization/teach/deactivation, 1 = running measurement
								Signal	0 = no signal or signal too weak, 1 = signal ok
								Warning	0 = no warning, 1 = warning, e.g., weak signal
								0	Not assigned (initial state = 0)
								0	Not assigned (initial state = 0)

Device input data

None

Part number code

HT10L1.3 / L69,200-M12

Operating principle

HT Laser diffuse sensors with background suppression

Series

10 10 series

Laser class

L1 Laser class 1 (in acc. with IEC 60825-1:2014)

Equipment

3 Membrane keyboard for teach-in

Assignment pin 4

L IO-Link (with dual channel, also push/pull switching output)

Assignment pin 2

6 Push/pull switching output

Assignment pin 5

9 Deactivation input (factory setting) or teach input (> 8VDC, configurable)

6 Push/pull switching output

X Do not connect

Electrical connection

-M12 M12 connector, 5-pin

,YYYY Cable, length YYYY mm with wire-end sleeves, 5-wire (no information = standard length 2000 mm)

,200-M12 Cable, length 200mm with M12 connector, 5-pin

Order guide

Connection: M12 connector, 5-pin

IO-Link 1.1/switching output, 1 push/pull switching output, deactivation input

IO-Link 1.1/switching output, 2 push/pull switching outputs

IO-Link 1.1/switching output, 1 push/pull switching output

Designation

HT10L1.3/L69-M12

HT10L1.3/L66-M12

HT10L1.3/L6X-M12

Part no.

50129537

50129540

50128388

Connection: cable, length 2000 mm with wire-end sleeves, 5-wire

IO-Link 1.1/switching output, 1 push/pull switching output, deactivation input

IO-Link 1.1/switching output, 2 push/pull switching outputs

IO-Link 1.1/switching output, 1 push/pull switching output

HT10L1.3/L69

HT10L1.3/L66

HT10L1.3/L6X

50129542

50129546

50129543

Connection: cable, length 200 mm with M12 connector, 5-pin

IO-Link 1.1/switching output, 1 push/pull switching output, deactivation input

IO-Link 1.1/switching output, 2 push/pull switching outputs

IO-Link 1.1/switching output, 1 push/pull switching output

HT10L1.3/L69,200-M12

HT10L1.3/L66,200-M12

HT10L1.3/L6X,200-M12

50129549

50129551

50129548

Accessories

Mounting system for mounting on rods Ø 10 mm

Mounting system for mounting on rods Ø 12 mm

Connection cable with M12 connector, angled, 5-pin, length 2m, PVC sheathing (many other connection cables are available)

IO-Link master set

BTU 460M-D10

BTU 460M-D12

K-D M12W-5P-2m-PVC

SET MD12-US2-IL1.1

+ accessories - diagnostics set

50128379

50128380

50104556

50121098

HT10

Laser diffuse sensors with background suppression

The following teach options are available:

The Q1, Q2 (Q3) switching outputs can be individually set.

	Teach options	Part designations
	Standard teach (object teach)	.../L6X_6_T..
	Press 2 to 7 sec	
	Teach against background	.../L6X_6_T..
	Press 7 to 12 sec	
	Light/dark switching	.../L6X_6_T..
	Press 12 to 17 sec	
	Window teach	.../L6T.P1..
	Upper limit	
	Press 7 to 12 sec	
	Lower limit	
	Press 12 to 17 sec	
	Teach against object	
Press up to 2 sec		

Teach process for light/dark switching

The following processes are identical for Q1, Q2, (Q3).

Q1, Q2 (Q3) can be individually set.

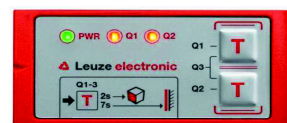

Teach

→ > 12 sec

Release

LED	Status LED	2 sec	7 sec	12 sec	Release	Status LED
1 Object is detected (distance to object ≤ set operating range)						
Light	→					Dark
Green LED	On	Flash simultaneously	Flash alternately	Flashing	-->	On
Yellow LED	On	Flash simultaneously	Flash alternately	On	-->	Off
Dark	→					Light
Green LED	On	Flash simultaneously	Flash alternately	Flashing	-->	On
Yellow LED	Off	Flash simultaneously	Flash alternately	On	-->	On
2 Object is not detected (distance to object > set operating range + reserve + hysteresis)						
Light	→					Dark
Green LED	On	Flash simultaneously	Flash alternately	Flashing	-->	On
Yellow LED	Off	Flash simultaneously	Flash alternately	On	-->	On
Dark	→					Light
Green LED	On	Flash simultaneously	Flash alternately	Flashing	-->	On
Yellow LED	On	Flash simultaneously	Flash alternately	On	-->	Off