

## Technical data sheet

### Diffuse sensor with background suppression

Part no.: 50127435

HT49CI.UC/M4-TB



For illustration purposes only

#### Contents

- Technical data
- Dimensioned drawings
- Electrical connection
- Circuit diagrams
- Diagrams
- Operation and display
- Part number code
- Notes
- Further information
- Accessories



## Technical data

### Basic data

Series	49C
Operating principle	Diffuse reflection principle with background suppression

### Optical data

Black-white error	< 10% up to 1200 mm
Operating range	Guaranteed operating range
Operating range, white 90%	0.005 ... 3 m
Operating range, gray 18%	0.02 ... 2 m
Operating range, black 6%	0.05 ... 1.5 m
Operating range limit	Typical operating range
Operating range limit, white 90%	0.005 ... 3 m
Adjustment range	120 ... 3,000 mm
Light source	LED, Infrared
Wavelength	860 nm
Transmitted-signal shape	Pulsed
LED group	Exempt group (in acc. with EN 62471)

### Electrical data

Protective circuit	Interference blanking Transient protection
--------------------	---

#### Performance data

Supply voltage $U_B$	20 ... 250 V, AC/DC
Power consumption (with AC)	1.5 V·A

#### Outputs

Number of digital switching outputs	1 Piece(s)
-------------------------------------	------------

#### Switching outputs

Voltage type	AC/DC
Switching current, max.	400 mA
Switching power	100 V·A
Switching voltage	250 V AC/DC

#### Switching output 1

Assignment	Connection 1, pin 4
Switching element	MOSFET semiconductor, NO (normally open)
Switching principle	Light/dark switchable

### Time behavior

Switching frequency	150 Hz
Response time	3.3 ms
Readiness delay	300 ms

### Connection

#### Connection 1

Function	Signal OUT Voltage supply
Type of connection	Terminal
Type of terminal	Spring-cage terminal
No. of pins	5 -pin

### Mechanical data

Dimension (W x H x L)	31 mm x 104 mm x 55.5 mm
Housing material	Plastic
Plastic housing	PC
Lens cover material	Plastic
Net weight	150 g
Housing color	Red
Type of fastening	Through-hole mounting Via optional mounting device

### Operation and display

Type of display	LED
Number of LEDs	2 Piece(s)
Operational controls	Multiturn potentiometer Teach button
Function of the operational control	Activation of the time module for dropout delay Light/dark switching Range adjustment Switching range adjustment

### Environmental data

Ambient temperature, operation	-40 ... 60 °C
Ambient temperature, storage	-40 ... 70 °C

### Certifications

Degree of protection	IP 67
Protection class	II
Certifications	c UL US
Standards applied	IEC 60947-5-2

### Classification

Customs tariff number	85365080
ECLASS 5.1.4	27270904
ECLASS 8.0	27270904
ECLASS 9.0	27270904
ECLASS 10.0	27270904
ECLASS 11.0	27270904
ECLASS 12.0	27270903
ECLASS 13.0	27270903
ETIM 5.0	EC002719
ETIM 6.0	EC002719
ETIM 7.0	EC002719
ETIM 8.0	EC002719

# Dimensioned drawings

All dimensions in millimeters

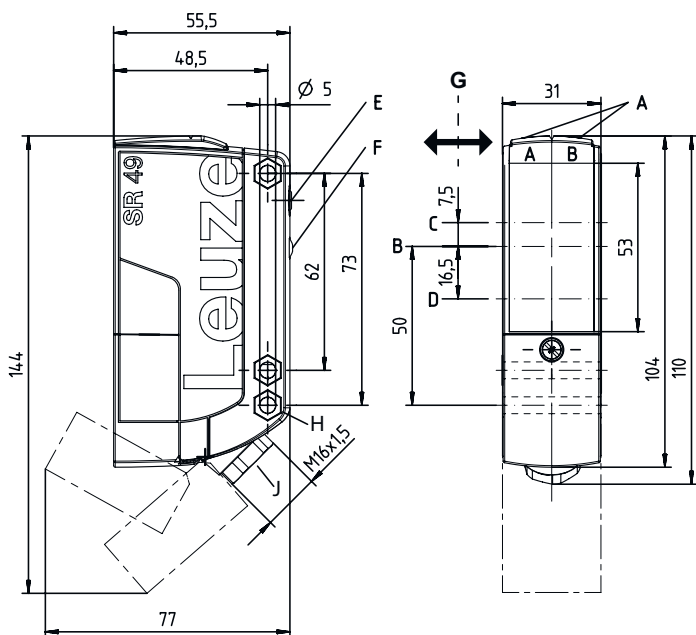

- AA Green LED
- AB Yellow LED
- B Optical axis
- C Receiver
- D Transmitter
- E Range adjustment
- F Teach button
- G Preferred entry direction
- H Countersinking for SK nut M5, 4.2 mm deep
- J Cable entry with M16x1.5 screw fitting for Ø5 ... 10 mm

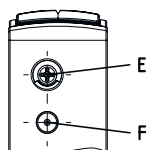

## Electrical connection

### Connection 1

<b>Function</b>	Signal OUT
	Voltage supply
<b>Type of connection</b>	Terminal
<b>Type of terminal</b>	Spring-cage terminal
<b>No. of pins</b>	5 -pin

Terminal	Assignment
1	+ / L1
2	- / N
3	n.c.
4	OUT 1
5	COM

## Circuit diagrams

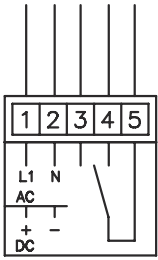

## Diagrams

Typ. response behavior (white 90%)

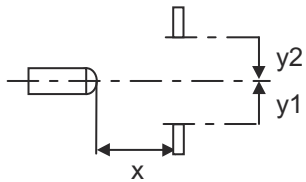
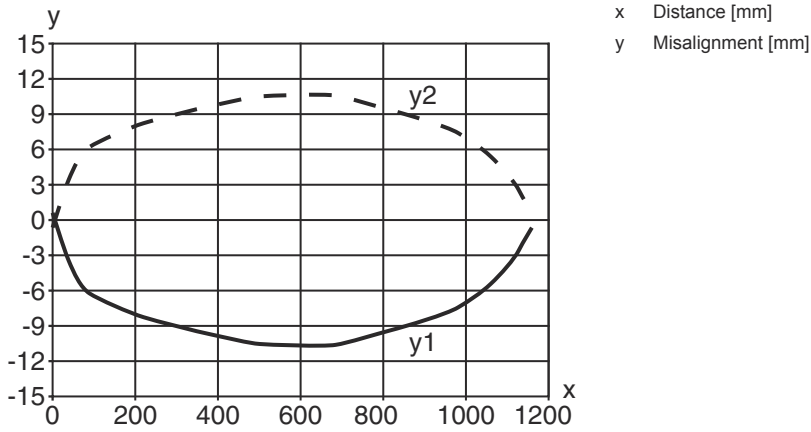

# Diagrams

## Typ. black/white behavior

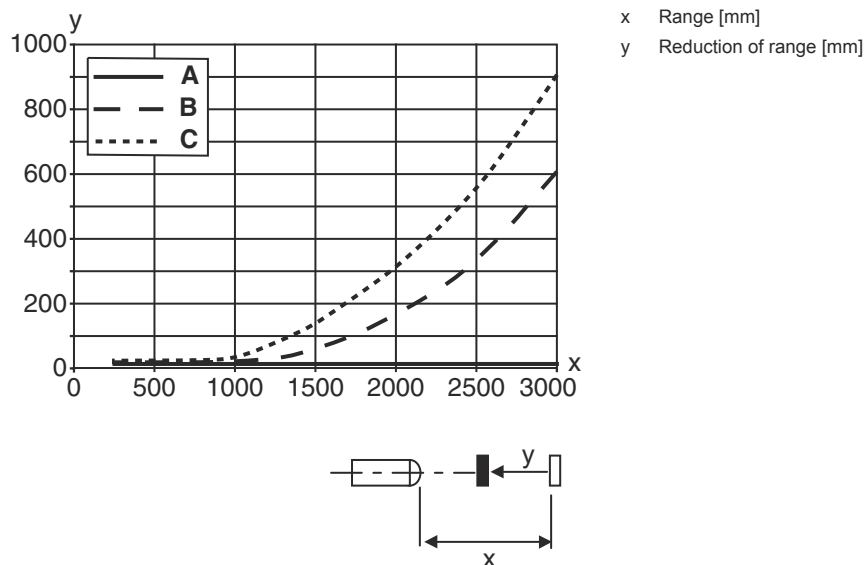

## Operation and display

LED	Display	Meaning
1	Green, continuous light	Operational readiness
2	Yellow, continuous light	Switching output/switching state

## Part number code

Part designation: **AAA49Cd.EEfG/iJ-KL**

<b>AAA49C</b>	<b>Operating principle / construction</b> PRK49C: Retro-reflective photoelectric sensor with polarization filter HT49C: Diffuse reflection sensor with background suppression LS49C: Throughbeam photoelectric sensor transmitter LE49C: Throughbeam photoelectric sensor receiver
<b>d</b>	<b>Light type</b> n/a: red light l: infrared light
<b>EE</b>	<b>Operating voltage</b> n/a: 10 ... 30 V, DC UC: 20 ... 250V AC/DC (all-mains design)
<b>f</b>	<b>Equipment</b> H: With heating D: Depolarizing media 1: 270° potentiometer 8: activation input (activation with high signal)



## Part number code

iJ	<b>Switching output / Function / OUT1OUT2</b> 2: NPN transistor output, light switching N: NPN transistor output, dark switching 4: PNP transistor output, light switching P: PNP transistor output, dark switching W: warning output TS: Relay, NC contact/NO contact M4: Low impedance MOSFET semiconductor switching output, NO contact
KL	<b>Electrical connection</b> TB: Terminal block - terminal compartment with spring terminals (5 x 1.5mm <sup>2</sup> ) n/a: cable, standard length 2000 mm

### Note

	ⓘ A list with all available device types can be found on the Leuze website at <a href="http://www.leuze.com">www.leuze.com</a> .
--	--

## Notes

 <b>Observe intended use!</b>	
	ⓘ This product is not a safety sensor and is not intended as personnel protection. ⓘ The product may only be put into operation by competent persons. ⓘ Only use the product in accordance with its intended use.

## Further information

- All-insulated, rating voltage 250 VAC
- With inductive or capacitive load, provide suitable spark extinction (snubber)

## Accessories

### Mounting technology - Mounting brackets

	Part no.	Designation	Article	Description
	50025570	BT 96	Mounting device	Design of mounting device: Angle, L-shape Fastening, at system: Through-hole mounting Mounting bracket, at device: Screw type Type of mounting device: Rigid Material: Metal

**Accessories****Mounting technology - Rod mounts**

	<b>Part no.</b>	<b>Designation</b>	<b>Article</b>	<b>Description</b>
	50128380	BTU 460M-D12	Mounting system	Design of mounting device: Mounting system Fastening, at system: For 12 mm rod Mounting bracket, at device: Screw type Type of mounting device: Adjustable, Turning, 360° Material: Metal

**Note**

A list with all available accessories can be found on the Leuze website in the Download tab of the article detailed page.