

Technical data sheet

Throughbeam photoelectric sensor receiver

Part no.: 50127446

LE49CI.UC/TS



Figure can vary

Contents

- Technical data
- Dimensioned drawings
- Electrical connection
- Circuit diagrams
- Diagrams
- Operation and display
- Suitable transmitters
- Part number code
- Notes
- Further information
- Accessories



Technical data

Basic data

Series	49C
Operating principle	Throughbeam principle
Device type	Receiver

Optical data

Operating range	Guaranteed operating range
Operating range	0 ... 120 m
Operating range limit	Typical operating range
Operating range limit	0.5 ... 150 m

Electrical data

Protective circuit	Polarity reversal protection
	Short circuit protected
	Transient protection

Performance data

Supply voltage U_B	20 ... 250 V, AC/DC
Power consumption (with AC)	1.5 V·A

Outputs

Number of digital switching outputs	2 Piece(s)
-------------------------------------	------------

Switching outputs

Voltage type	AC/DC
Switching current, max.	2,500 mA
Switching voltage	250 V AC/DC

Switching output 1

Switching element	Relay, NC
Switching principle	Light switching

Switching output 2

Switching element	Relay, NO
Switching principle	Light switching

Time behavior

Switching frequency	25 Hz
Response time	20 ms
Readiness delay	300 ms

Connection

Connection 1

Function	Signal OUT
	Voltage supply
Type of connection	Cable
Cable length	2,000 mm
Sheathing material	PVC
Cable color	Black
Number of conductors	5 -wire
Wire cross section	0.34 mm ²

Mechanical data

Dimension (W x H x L)	31 mm x 104 mm x 55.5 mm
Housing material	Plastic
Plastic housing	PC
Lens cover material	Plastic
Net weight	150 g
Housing color	Red
Type of fastening	Through-hole mounting Via optional mounting device

Operation and display

Type of display	LED
Number of LEDs	3 Piece(s)

Environmental data

Ambient temperature, operation	-40 ... 60 °C
Ambient temperature, storage	-40 ... 70 °C

Certifications

Degree of protection	IP 67
Protection class	II
Certifications	c UL US
Standards applied	IEC 60947-5-2

Classification

Customs tariff number	85365080
ECLASS 5.1.4	27270901
ECLASS 8.0	27270901
ECLASS 9.0	27270901
ECLASS 10.0	27270901
ECLASS 11.0	27270901
ECLASS 12.0	27270901
ECLASS 13.0	27270901
ETIM 5.0	EC002716
ETIM 6.0	EC002716
ETIM 7.0	EC002716
ETIM 8.0	EC002716

Dimensioned drawings

All dimensions in millimeters

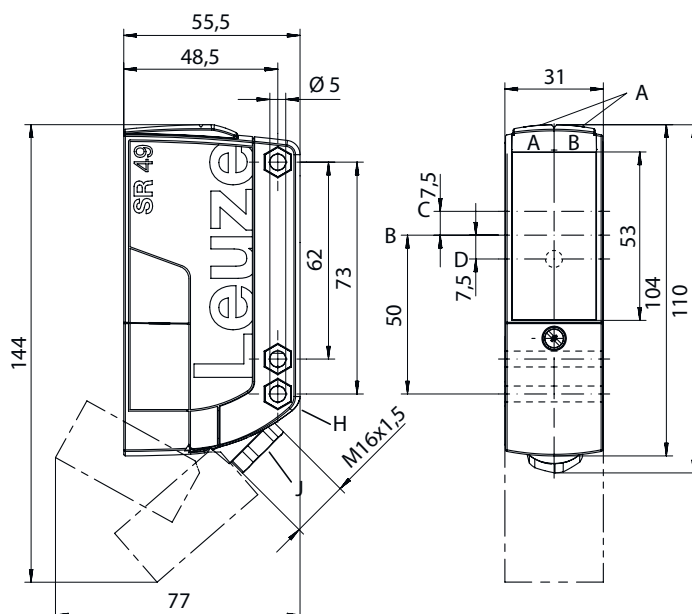

AA Green LED

AB Yellow LED

B Optical axis

C Receiver

D Yellow LED

G Countersinking for SK nut M5, 4.2 mm deep

J Cable entry with M16x1.5 screw fitting for Ø 5 ... 10 mm

Electrical connection

Connection 1

Function	Signal OUT
	Voltage supply
Type of connection	Cable
Cable length	2,000 mm
Sheathing material	PVC
Cable color	Black
Number of conductors	5 -wire
Wire cross section	0.34 mm ²

Conductor color

Conductor assignment

Brown	+ / L1
Blue	- / N
White	OUT 1
Gray	COM
Black	OUT 2

Circuit diagrams

AC

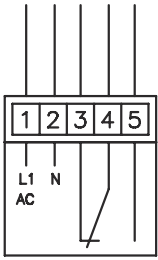

DC

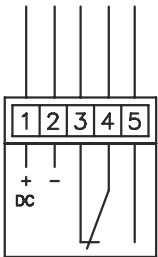

Diagrams

Typ. response behavior

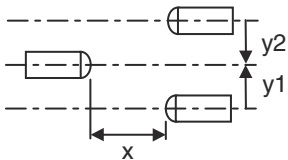
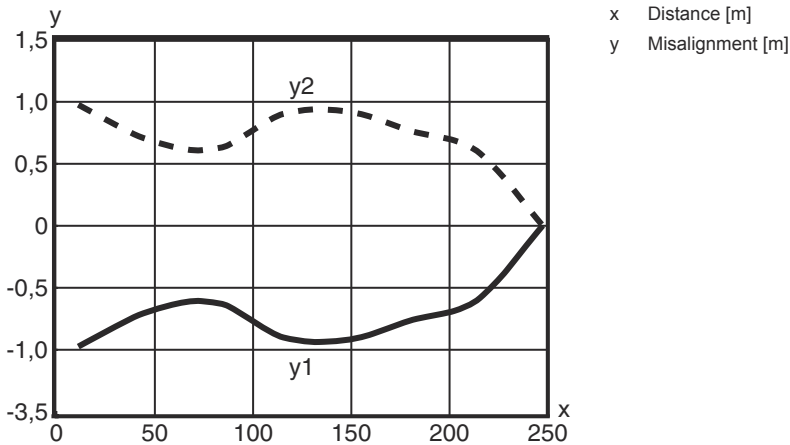

Operation and display

LED	Display	Meaning
1	Green, continuous light	Operational readiness
2	Yellow, continuous light	Light path free

Operation and display

LED	Display	Meaning
2	Yellow, flashing	Light path free, no function reserve
3	Yellow, continuous light (behind lens cover)	Light path free
	Yellow, flashing (behind lens cover)	Light path free, minimum function reserve

Suitable transmitters

	Part no.	Designation	Article	Description
	50127440	LS49CI.UC	Throughbeam photoelectric sensor transmitter	Operating range limit: 0 ... 150 m Light source: LED, Infrared Supply voltage: AC/DC Connection: Cable, 2,000 mm, 2 -wire

Part number code

Part designation: AAA49Cd.EEfG/iJ-KL

AAA49C	Operating principle / construction PRK49C: Retro-reflective photoelectric sensor with polarization filter HT49C: Diffuse reflection sensor with background suppression LS49C: Throughbeam photoelectric sensor transmitter LE49C: Throughbeam photoelectric sensor receiver
d	Light type n/a: red light l: infrared light
EE	Operating voltage n/a: 10 ... 30 V, DC UC: 20 ... 250V AC/DC (all-mains design)
f	Equipment H: With heating D: Depolarizing media 1: 270° potentiometer 8: activation input (activation with high signal)
iJ	Switching output / Function / OUT1OUT2 2: NPN transistor output, light switching N: NPN transistor output, dark switching 4: PNP transistor output, light switching P: PNP transistor output, dark switching W: warning output TS: Relay, NC contact/NO contact M4: Low impedance MOSFET semiconductor switching output, NO contact
KL	Electrical connection TB: Terminal block - terminal compartment with spring terminals (5 x 1.5mm ²) n/a: cable, standard length 2000 mm

Note



A list with all available device types can be found on the Leuze website at www.leuze.com.

Notes



Observe intended use!



- ⌘ This product is not a safety sensor and is not intended as personnel protection.
- ⌘ The product may only be put into operation by competent persons.
- ⌘ Only use the product in accordance with its intended use.

Further information

- All-insulated, rating voltage 250 VAC
- With inductive or capacitive load, provide suitable spark extinction (snubber)

Accessories

Mounting technology - Mounting brackets

	Part no.	Designation	Article	Description
	50025570	BT 96	Mounting device	Design of mounting device: Angle, L-shape Fastening, at system: Through-hole mounting Mounting bracket, at device: Screw type Type of mounting device: Rigid Material: Metal

Mounting technology - Rod mounts

	Part no.	Designation	Article	Description
	50128380	BTU 460M-D12	Mounting system	Design of mounting device: Mounting system Fastening, at system: For 12 mm rod Mounting bracket, at device: Screw type Type of mounting device: Adjustable, Turning, 360° Material: Metal

Note



- ⌘ A list with all available accessories can be found on the Leuze website in the Download tab of the article detailed page.