

## Technical data sheet

### Polarized retro-reflective photoelectric sensor

Part no.: 50139672

PRK25C.TT3/4P



Figure can vary

#### Contents

- Technical data
- Dimensioned drawings
- Electrical connection
- Diagrams
- Operation and display
- Reflectors & reflective tapes
- Part number code
- Notes
- Further information
- Accessories



## Technical data

### Basic data

|                     |   |
|---------------------|---|
| Series              | 25C   |
| Operating principle | Reflection principle  |
| Application         | Detection of highly transparent bottles<br>Detection of transparent films |

### Special version

|                 |                                      |
|-----------------|--------------------------------------|
| Special version | Autocollimation<br>Tracking function |
|-----------------|--------------------------------------|

### Optical data

|                          |   |
|--------------------------|---|
| Operating range          | Guaranteed operating range                |
| Operating range          | 0 ... 3 m, With reflector TK(S) 100x100   |
| Operating range limit    | Typical operating range                   |
| Operating range limit    | 0 ... 3.6 m, With reflector TK(S) 100x100 |
| Light source             | LED, Red                                  |
| Wavelength               | 640 nm                                    |
| Transmitted-signal shape | Pulsed                                    |
| LED group                | Exempt group (in acc. with EN 62471)      |

### Electrical data

|                    |   |
|--------------------|---|
| Protective circuit | Polarity reversal protection<br>Short circuit protected |
|--------------------|---|

#### Performance data

|                      |  |
|----------------------|--|
| Supply voltage $U_B$ | 10 ... 30 V, DC, Incl. residual ripple |
| Residual ripple      | 0 ... 15 %, From $U_B$                 |
| Open-circuit current | 0 ... 20 mA                            |

#### Outputs

|                                     |            |
|-------------------------------------|------------|
| Number of digital switching outputs | 2 Piece(s) |
|-------------------------------------|------------|

#### Switching outputs

|                         |   |
|-------------------------|---|
| Voltage type            | DC  |
| Switching current, max. | 100 mA  |
| Switching voltage       | high: $\geq(U_B - 2.5V)$<br>low: $\leq 2.5 V$ |

#### Switching output 1

|                     |                 |
|---------------------|-----------------|
| Switching element   | Transistor, PNP |
| Switching principle | Light switching |

#### Switching output 2

|                     |                 |
|---------------------|-----------------|
| Switching element   | Transistor, PNP |
| Switching principle | Dark switching  |

### Time behavior

|                     |          |
|---------------------|----------|
| Switching frequency | 1,500 Hz |
| Response time       | 0.33 ms  |
| Readiness delay     | 300 ms   |

### Connection 1

|                      |                              |
|----------------------|------------------------------|
| Function             | Signal OUT<br>Voltage supply |
| Type of connection   | Cable                        |
| Cable length         | 2,000 mm                     |
| Sheathing material   | PUR                          |
| Cable color          | Black                        |
| Number of conductors | 4 -wire                      |
| Wire cross section   | 0.2 mm <sup>2</sup>          |

### Mechanical data

|                            |  |
|----------------------------|--|
| Dimension (W x H x L)      | 15 mm x 42.7 mm x 30 mm  |
| Housing material           | Plastic  |
| Plastic housing            | ABS  |
| Lens cover material        | Plastic  |
| Net weight                 | 55 g   |
| Housing color              | Red  |
| Type of fastening          | Through-hole mounting with M4 thread<br>Via optional mounting device |
| Compatibility of materials | ECOLAB   |

### Operation and display

|                                     |                        |
|-------------------------------------|------------------------|
| Type of display                     | LED                    |
| Number of LEDs                      | 2 Piece(s)             |
| Operational controls                | Teach button           |
| Function of the operational control | Sensitivity adjustment |

### Environmental data

|                                |               |
|--------------------------------|---------------|
| Ambient temperature, operation | -40 ... 60 °C |
| Ambient temperature, storage   | -40 ... 70 °C |

### Certifications

|                      |                 |
|----------------------|-----------------|
| Degree of protection | IP 67<br>IP 69K |
| Protection class     | III             |
| Certifications       | c UL US         |
| Standards applied    | IEC 60947-5-2   |

### Classification

|                       |          |
|-----------------------|----------|
| Customs tariff number | 85365019 |
| ECLASS 5.1.4          | 27270902 |
| ECLASS 8.0            | 27270902 |
| ECLASS 9.0            | 27270902 |
| ECLASS 10.0           | 27270902 |
| ECLASS 11.0           | 27270902 |
| ECLASS 12.0           | 27270902 |
| ECLASS 13.0           | 27270902 |
| ETIM 5.0              | EC002717 |
| ETIM 6.0              | EC002717 |
| ETIM 7.0              | EC002717 |
| ETIM 8.0              | EC002717 |

# Dimensioned drawings

All dimensions in millimeters

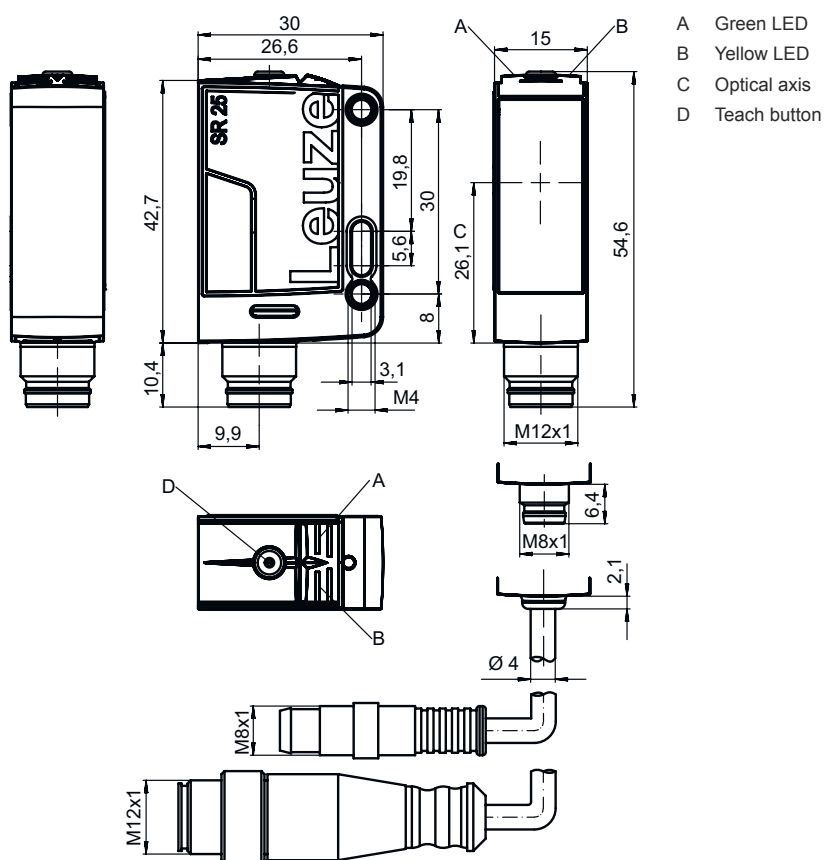

## Electrical connection

### Connection 1

|                      |                     |
|----------------------|---------------------|
| Function             | Signal OUT          |
|                      | Voltage supply      |
| Type of connection   | Cable               |
| Cable length         | 2,000 mm            |
| Sheathing material   | PUR                 |
| Cable color          | Black               |
| Number of conductors | 4 -wire             |
| Wire cross section   | 0.2 mm <sup>2</sup> |

### Conductor color

### Conductor assignment

|       |       |
|-------|-------|
| Brown | V+    |
| White | OUT 2 |
| Blue  | GND   |
| Black | OUT 1 |

# Diagrams

Typ. response behavior (TKS100x100)

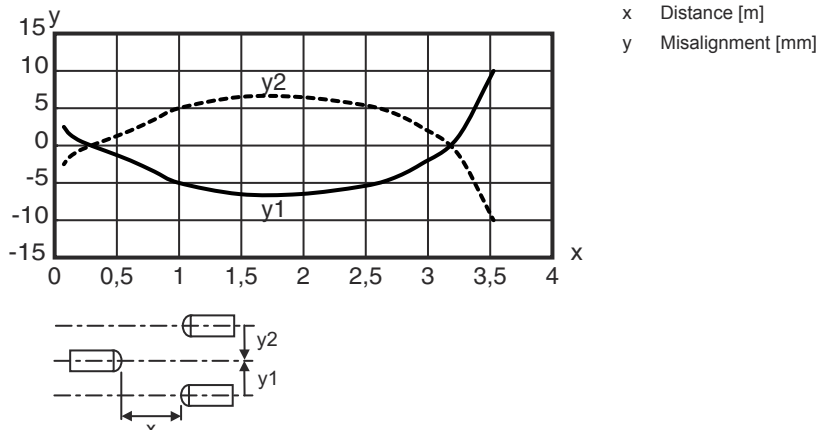





## Operation and display

| LED | Display                  | Meaning                              |
|-----|--------------------------|--------------------------------------|
| 1   | Green, continuous light  | Operational readiness                |
| 2   | Yellow, continuous light | Light path free                      |
|     | Yellow, flashing         | Light path free, no function reserve |

## Reflectors & reflective tapes

|  | Part no. | Designation   | Operating range<br>Operating range<br>limit | Description  |
|--|----------|---------------|---|--|
|  | 50117583 | MTKS 50x50.1  | 0 ... 2 m<br>0 ... 2.4 m                    | Design: Rectangular<br>Triple reflector size: 1.2 mm<br>Reflective surface: 50 mm x 50 mm<br>Material: Plastic<br>Base material: Plastic<br>Chemical designation of the material: PMMA8N<br>Fastening: Through-hole mounting, Adhesive |
|  | 50108300 | REF 4-A-50x50 | 0 ... 0.5 m<br>0 ... 0.6 m                  | Design: Rectangular<br>Reflective surface: 50 mm x 50 mm<br>Material: Plastic<br>Chemical designation of the material: PMMA<br>Fastening: Self-adhesive  |
|  | 50110192 | REF 6-A-50x50 | 0 ... 1.3 m<br>0 ... 1.5 m                  | Design: Rectangular<br>Triple reflector size: 0.3 mm<br>Reflective surface: 50 mm x 50 mm<br>Material: Plastic<br>Chemical designation of the material: PMMA<br>Fastening: Self-adhesive   |
|  | 50003192 | TK 100x100    | 0 ... 3 m<br>0 ... 3.6 m                    | Design: Rectangular<br>Triple reflector size: 4 mm<br>Reflective surface: 96 mm x 96 mm<br>Material: Plastic<br>Base material: Plastic<br>Chemical designation of the material: PMMA8N<br>Fastening: Rear side can be glued            |

## Reflectors & reflective tapes

|  | Part no. | Designation | Operating range<br>Operating range<br>limit | Description  |
|--|----------|-------------|---|--|
|   | 50022816 | TKS 100X100 | 0 ... 3 m<br>0 ... 3.6 m                    | Design: Rectangular<br>Triple reflector size: 4 mm<br>Reflective surface: 96 mm x 96 mm<br>Material: Plastic<br>Base material: Plastic<br>Chemical designation of the material: PMMA8N<br>Fastening: Through-hole mounting, Adhesive   |
|   | 50081283 | TKS 20X40   | 0 ... 1.1 m<br>1.3 ... 2.4 m                | Design: Rectangular<br>Triple reflector size: 2.3 mm<br>Reflective surface: 16 mm x 38 mm<br>Material: Plastic<br>Base material: Plastic<br>Chemical designation of the material: PMMA8N<br>Fastening: Through-hole mounting, Adhesive |
|   | 50040820 | TKS 40X60   | 0 ... 2 m<br>0 ... 2.4 m                    | Design: Rectangular<br>Triple reflector size: 4 mm<br>Reflective surface: 37 mm x 56 mm<br>Material: Plastic<br>Base material: Plastic<br>Chemical designation of the material: PMMA8N<br>Fastening: Through-hole mounting, Adhesive   |
|  | 50109257 | TKS 40x60.1 | 0 ... 1.9 m<br>0 ... 2.3 m                  | Design: Rectangular<br>Triple reflector size: 2.3 mm<br>Reflective surface: 37 mm x 56 mm<br>Material: Plastic<br>Base material: Plastic<br>Chemical designation of the material: PMMA8N<br>Fastening: Through-hole mounting, Adhesive |

## Part number code

Part designation: AAA25C d EE-f.GGH/IJ-K

|               |   |
|---------------|---|
| <b>AAA25C</b> | <b>Operating principle / construction</b><br>HT25C: Diffuse reflection sensor with background suppression<br>PRK25C: Retro-reflective photoelectric sensor with polarization filter<br>LS25C: Throughbeam photoelectric sensor transmitter<br>LE25C: Throughbeam photoelectric sensor receiver<br>DRT25C: Dynamic reference diffuse sensor  |
| <b>d</b>      | <b>Light type</b><br>n/a: red light<br>I: infrared light  |
| <b>EE</b>     | <b>Light source</b><br>n/a: LED<br>L1: laser class 1<br>L2: laser class 2   |
| <b>f</b>      | <b>Preset range (optional)</b><br>n/a: operating range acc. to data sheet<br>xxxF: Preset range [mm]  |
| <b>GG</b>     | <b>Equipment</b><br>A: Autocollimation principle (single lens)<br>S: small light spot<br>D: Detection of stretch-wrapped objects<br>X: extended model<br>HF: Suppression of HF illumination (LED)<br>XL: Extra long light spot<br>T: autocollimation principle (single lens) for highly transparent bottles without tracking<br>TT: autocollimation principle (single lens) for highly transparent bottles with tracking<br>F: Foreground suppression<br>R: greater operating range<br>SL: Slit diaphragm |

## Part number code

|          |   |
|----------|---|
| <b>H</b> | <b>Operating range adjustment</b><br>1: 270° potentiometer<br>2: multiturn potentiometer<br>3: teach-in via button<br>R: greater operating range  |
| <b>i</b> | <b>Switching output/function OUT 1/IN: Pin 4 or black conductor</b><br>2: NPN transistor output, light switching<br>N: NPN transistor output, dark switching<br>4: PNP transistor output, light switching<br>P: PNP transistor output, dark switching<br>X: pin not used<br>8: activation input (activation with high signal)<br>L: IO-Link interface (SIO mode: PNP light switching, NPN dark switching)<br>6: push-pull switching output, PNP light switching, NPN dark switching<br>G: Push-pull switching output, PNP dark switching, NPN light switching |
| <b>J</b> | <b>Switching output / function OUT 2/IN: pin 2 or white conductor</b><br>2: NPN transistor output, light switching<br>N: NPN transistor output, dark switching<br>4: PNP transistor output, light switching<br>P: PNP transistor output, dark switching<br>W: warning output<br>X: pin not used<br>6: push-pull switching output, PNP light switching, NPN dark switching<br>T: teach-in via cable<br>G: Push-pull switching output, PNP dark switching, NPN light switching<br>8: activation input (activation with high signal)                             |
| <b>K</b> | <b>Electrical connection</b><br>n/a: cable, standard length 2000 mm, 4-wire<br>200-M12: cable, length 200 mm with M12 connector, 4-pin, axial (plug)<br>M8: M8 connector, 4-pin (plug)<br>M12: M12 connector, 4-pin (plug)<br>200-M8: cable, length 200 mm with M8 connector, 4-pin, axial (plug)   |

### Note



↪ A list with all available device types can be found on the Leuze website at [www.leuze.com](http://www.leuze.com).

## Notes



### Observe intended use!



- ↪ This product is not a safety sensor and is not intended as personnel protection.
- ↪ The product may only be put into operation by competent persons.
- ↪ Only use the product in accordance with its intended use.

## Further information



- Light source: Average life expectancy 100,000 h at an ambient temperature of 25 °C
- Sum of the output currents for both outputs 100 mA

## Accessories

### Mounting technology - Mounting brackets

|   | Part no. | Designation | Article          | Description   |
|---|----------|-------------|------------------|---|
|  | 50118543 | BT 300M.5   | Mounting bracket | Design of mounting device: Angle, L-shape<br>Fastening, at system: Through-hole mounting<br>Mounting bracket, at device: Screw type, Suited for M4 screws<br>Type of mounting device: Adjustable<br>Material: Stainless steel |

### Mounting technology - Rod mounts

|  | Part no. | Designation  | Article         | Description  |
|--|----------|--------------|-----------------|--|
|   | 50117829 | BTP 200M-D12 | Mounting system | Design of mounting device: Protection hood<br>Fastening, at system: For 12 mm rod<br>Mounting bracket, at device: Screw type<br>Type of mounting device: Clampable, Adjustable, Turning, 360°<br>Material: Metal   |
|  | 50117252 | BTU 300M-D12 | Mounting system | Design of mounting device: Mounting system<br>Fastening, at system: For 12 mm rod, Sheet-metal mounting<br>Mounting bracket, at device: Screw type, Suited for M4 screws<br>Type of mounting device: Clampable, Adjustable, Turning, 360°<br>Material: Metal |

### Standard reflectors

|   | Part no. | Designation | Article   | Description  |
|---|----------|-------------|-----------|--|
|  | 50109257 | TKS 40x60.1 | Reflector | Design: Rectangular<br>Triple reflector size: 2.3 mm<br>Reflective surface: 37 mm x 56 mm<br>Material: Plastic<br>Base material: Plastic<br>Chemical designation of the material: PMMA8N<br>Fastening: Through-hole mounting, Adhesive |

### Micro-triad-type reflectors

|   | Part no. | Designation  | Article   | Description  |
|---|----------|--------------|-----------|--|
|  | 50117583 | MTKS 50x50.1 | Reflector | Design: Rectangular<br>Triple reflector size: 1.2 mm<br>Reflective surface: 50 mm x 50 mm<br>Material: Plastic<br>Base material: Plastic<br>Chemical designation of the material: PMMA8N<br>Fastening: Through-hole mounting, Adhesive |

## Accessories

### Note



🔗 A list with all available accessories can be found on the Leuze website in the Download tab of the article detailed page.