

PRK 3B / PRK 53 Retro-reflective photoelectric sensors with polarization filter for bottles

en 03-2017/11 50112873-01



0 ... 3.5m



- Polarized retro-reflective photoelectric sensor, autocollimation optics with visible red light
- Particularly suited for highly transparent bottles (PET and glass)
- EasyTune for switching threshold adjustment
- Yellow LED indicates the switching output
- 11 % / 18 % switching threshold
- Simple adjustment via lockable teach button

Accessories:

(available separately)

- Cables with M8 connector (KD ...)
- Cables for food and beverages
- Reflectors for the foods industry
- Reflectors for the pharmaceutical industry
- Reflective tapes
- Mounting devices

Dimensioned drawing

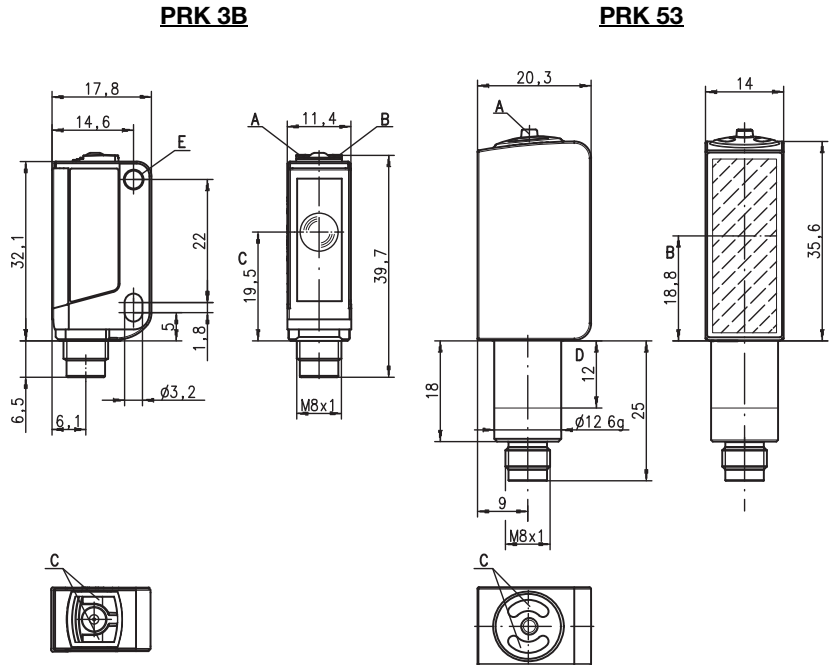

- A** Teach button
- B** Optical axis
- C** Indicator diodes
- D** Permissible clamping range
- E** Attachment sleeve

Electrical connection

Plug connection, 3-pin

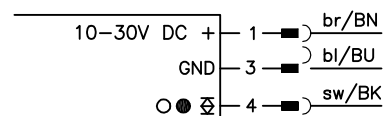

We reserve the right to make changes • PAL_PRK3BPRK536D421_en_50112873_01.fm

Specifications

Optical data

Typ. operating range limit ¹⁾	0 ... 3.5m (with TK(S) 100 x 100)
Operating range ²⁾	see tables
Light source ³⁾	LED (modulated light)
Wavelength	620nm (visible red light, polarized)

Timing

Switching frequency	1000Hz
Response time	0.5ms
Delay before start-up	≤ 300ms

Electrical data

Operating voltage U_B ⁴⁾	10 ... 30VDC (incl. residual ripple)
Residual ripple	≤ 15% of U_B
Open-circuit current	≤ 18mA
Switching output .../6D.421	1 push-pull switching output pin 4: PNP dark switching, NPN light switching light/dark reversible
Function characteristics	light/dark reversible
Signal voltage high/low	$\geq (U_B - 2V) / \leq 2V$
Output current	max. 100mA
Sensitivity	setting via teach-in

Indicators

Green LED	ready
Yellow LED	Switching output

Mechanical data

Housing	Plastic (PC-ABS); 1 attachment sleeve, nickel-plated steel	Stainless steel AISI 316L, DIN X2CrNiMo17132, W.Nr1.4404, HYGIENE design, housing roughness $R_a \leq 2.5$ ⁵⁾ coated plastic (PMMA), scratch resistant and non-diffusive 50g
Optics cover	plastic (PMMA)	
Weight	10g	
Connection type	M8 connector 3-pin	

Environmental data

Ambient temperature (operation/storage)	-30°C ... +55°C / -30°C ... +70°C	-30°C ... +70°C ⁶⁾ / -30°C ... +70°C
Protective circuit ⁷⁾	2, 3	
VDE safety class	III	
Protection class	IP 67	
Light source	free group (in accordance with EN 62471)	
Standards applied	IEC 60947-5-2	
Certifications	UL 508, C22.2 No.14-13 ^{4) 6) 8)}	

- 1) Typ. operating range limit: max. attainable range without performance reserve
- 2) Operating range: recommended range with performance reserve
- 3) Average life expectancy 100,000h at an ambient temperature of 25°C
- 4) For UL applications: for use in class 2 circuits according to NEC only
- 5) Typical value for the stainless steel housing
- 6) UL certified in the temperature range -30°C to 55°C,
- 7) 2=polarity reversal protection, 3=short-circuit protection for all transistor outputs
- 8) These proximity switches shall be used with UL Listed Cable assemblies rated 30V, 0.24A min, in the field installation

Remarks

Observe intended use!

- ☞ This product is not a safety sensor and is not intended as personnel protection.
- ☞ The product may only be put into operation by competent persons.
- ☞ Only use the product in accordance with the intended use.

UL REQUIREMENTS

Enclosure Type Rating: Type 1

For Use in NFPA 79 Applications only.

Adapters providing field wiring means are available from the manufacturer. Refer to manufacturers information.

CAUTION – the use of controls or adjustments or performance of procedures other than those specified herein may result in hazardous radiation exposure.

ATTENTION! Si d'autres dispositifs d'alignement que ceux préconisés ici sont utilisés ou s'il est procédé autrement qu'indiqué, cela peut entraîner une exposition à des rayonnements et un danger pour les personnes.

Tables

Reflectors in food quality		Operating range
1	TK(S) 100x100	0 ... 3.0m
2	TK 40x60	0 ... 2.0m
3	Tape 6 50x50	0 ... 1.2m
4	TK 20x40	0 ... 1.0m
5	Tape 4 50x50	0 ... 0.5m

1	0	3	3,6
2	0	2,0	2,4
3	0	1,2	1,4
4	0	1,0	1,2
5	0	0,5	0,6

Pharmaceutical reflectors		Operating range
1	TK(S) 40x60.P	0 ... 1.2m
2	TK BR53	0 ... 1.0m
3	TK(S) 20x40.P	0 ... 0.7m
4	TK(S) 20.P	0 ... 0.5m
5	MTK(S) 14x23.P	0 ... 0.25m
6	TK 10.P	0 ... 0.2m

1	0	1,2	1,4
2	0	1,0	1,2
3	0	0,7	0,8
4	0	0,5	0,6
5	0	0,25	0,3
6	0	0,2	0,25

□ Operating range [m]
▒ Typ. operating range limit [m]

TK ... = adhesive
TKS ... = screw type

Diagrams

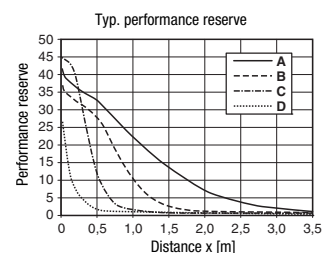
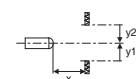
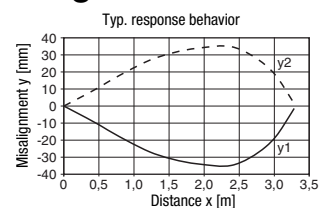

- A TK 100x100
- B TKS 40x60
- C TKS 20x40
- D Tape 4: 50x50

PRK 3B / PRK 53 Retro-reflective photoelectric sensors with polarization filter for bottles

Order guide

Selection table		Order code →			
Equipment ↓		PRK 3B/6D.421-S8.3 Part No. 50113278	PRK 53/6D.421-S8.3 Part No. 50113279		
Switching output	1 x push-pull switching output	●	●		
Switching function	light switching				
	dark switching	●	●		
	light/dark switching configurable	●	●		
Connection	M8 connector, 4-pin				
	M8 connector, 3-pin	●	●		
	cable 200mm with M8 connector, 4-pin				
Configuration	teach-in via button	●	●		
Indicators	LED green: ready + teach sequence	●	●		
	yellow LED: switching output	●	●		
Detection	Foils < 20 µm thick				
	Foils > 20 µm thick	●	●		
	Bottles (PET and glass)	●	●		

Remarks

Adaptor plate for **PRK 3B...**: BT 3.2 (part no. 50103844) for alternative mounting on holes with 25.4mm spacing (Omron E3Z, Sick W100...)

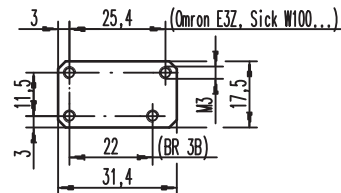

Mounting system for **PRK 3B...**:



- ① = BT 3
(part no. 50060511)
- ②+③ = BT 3.1 ¹⁾
(part no. 50105585)
- ①+②+③ = BT 3B
(part no. 50105546)

1) Packaging unit: PU = 10 pcs.

PRK 53...

Tested chemicals are listed at the beginning of the product description.

Secure using a set screw in the marked area only. Max. tightening torque 3Nm.

Sensor adjustment (teach) via teach button



- **Prior to teaching:**
Clear the light path to the reflector!
The device setting is stored in a fail-safe way. A reconfiguration following voltage interruption or switch-off is thus not required.

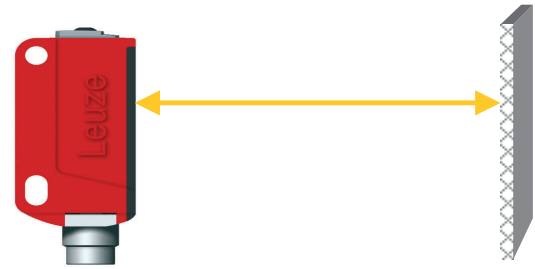

Teach for 11% sensor sensitivity (highly transparent bottles and foils with thickness > 20µm)

- Press teach button until both LEDs flash **simultaneously**.
- Release teach button.
- Ready.



After the teaching, the sensor switches when about 11% of the light beam are covered by the object.

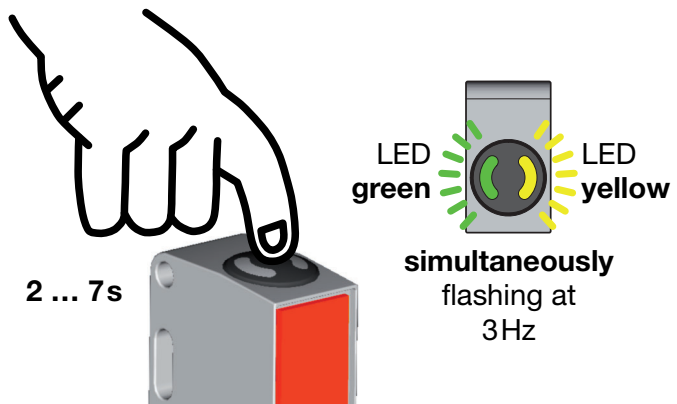

Teach for 18% sensor sensitivity (standard bottles)

- Press teach button until both LEDs flash **alternatingly**.
- Release teach button.
- Ready.



After the teaching, the sensor switches when about 18% of the light beam are covered by the object.

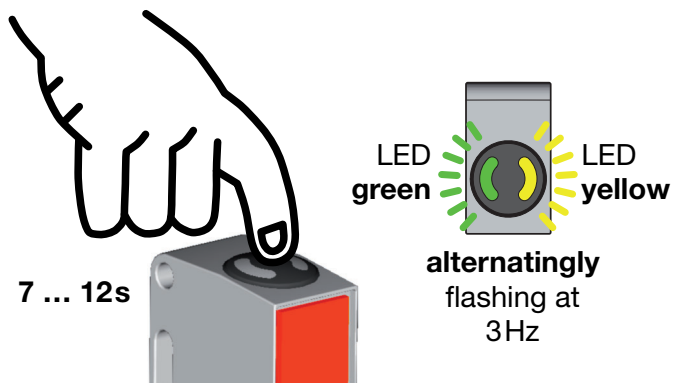

PRK 3B / PRK 53 Retro-reflective photoelectric sensors with polarization filter for bottles

Teaching for maximum operating range (factory setting at delivery)

- Prior to teaching:
Cover the light path to the reflector!
- Press teach button until both LEDs flash **simultaneously**.
- Release teach button.
- Ready.

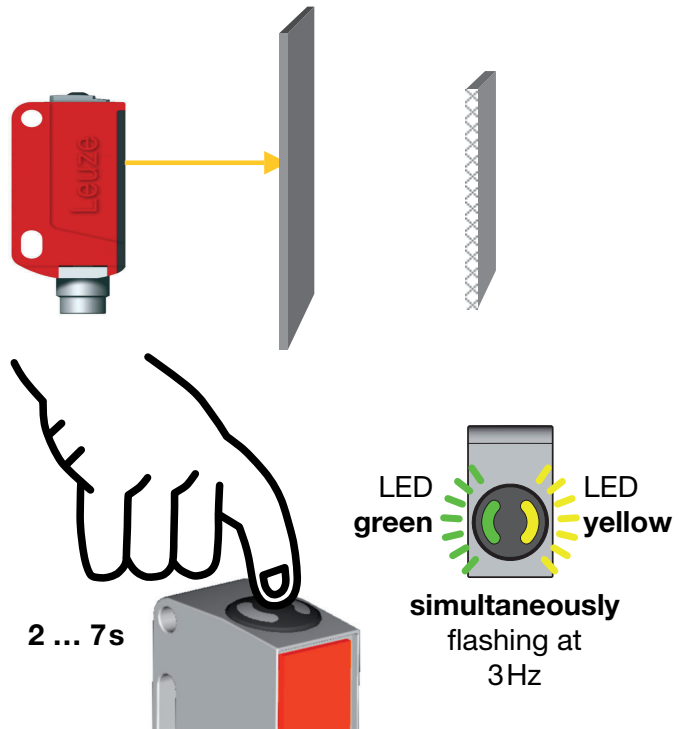

Adjusting the switching behavior of the switching output – light/dark switching

- Press teach button until the green LED flashes. The yellow LED displays the current setting of the switching output:
ON = output switches on light
OFF = output switches on dark
- Continue to press the teach button in order to change the switching behavior.
- Release teach button.
- Ready.

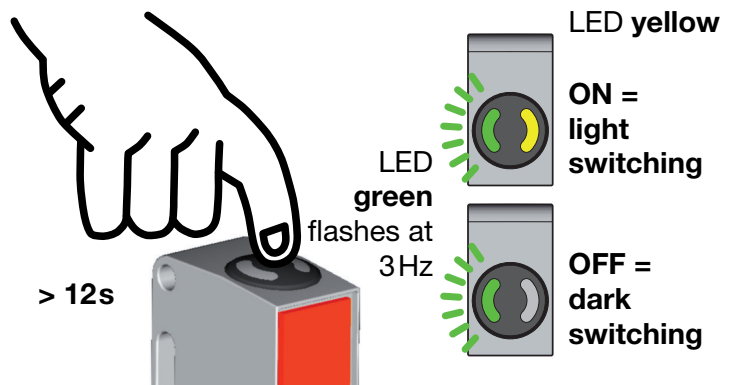

EasyTune - fine tuning of the sensitivity in 4% increments

- **Following power-on and completed teach process: Green LED illuminates continuously: ready for operation**
Yellow LED: switching output active/not active
- **Increasing sensitivity by +4% (increment):**
Each time the button is pressed between 200ms and 2s, the switching threshold is incremented. For example: switching threshold 18% → 22% after EasyTune.

The press of the button is confirmed by **one green flash of the green LED** - the new switching threshold is now valid.

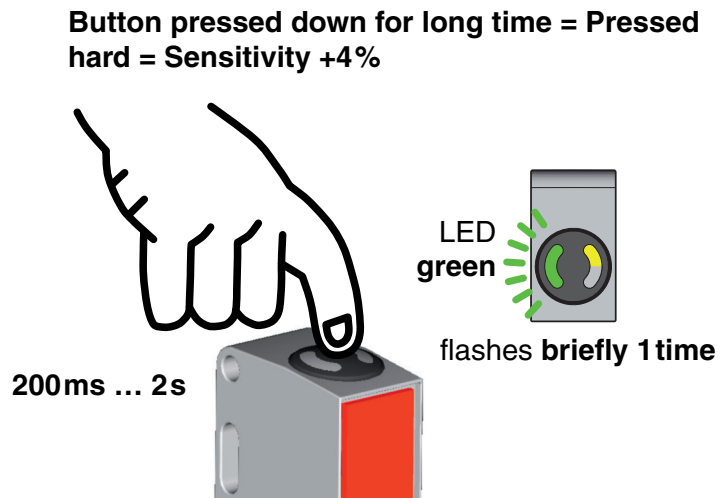

- **Decreasing sensitivity by -4% (decrement):**
Each time the button is pressed between 2ms and 200ms, the switching threshold is decremented. For example: switching threshold 18% → 14% after EasyTune.

The press of the button is confirmed by **one green flash of the green LED** - the new switching threshold is now valid.

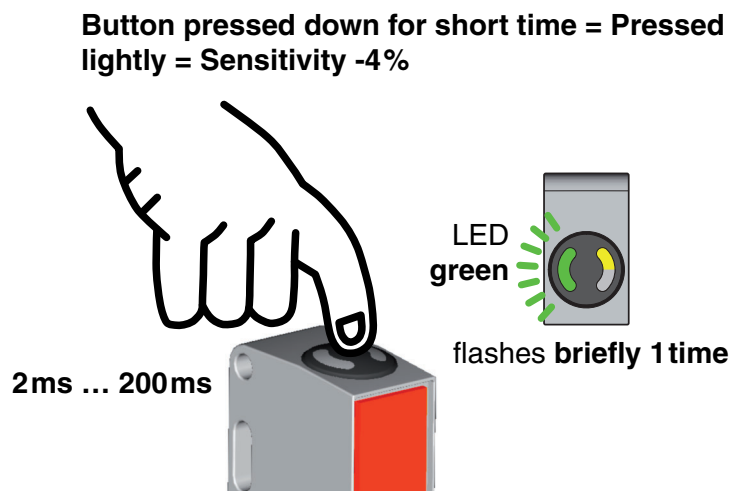

If the upper or lower end of the adjustment range is reached, the green LED flashes with a considerably higher frequency of approx. 6Hz.

The yellow LED always shows the state of the switching output!