

## Technical data sheet

### Polarized retro-reflective photoelectric sensor

Part no.: 50140142

PRK412B/4X-M12

#### Contents

- Technical data
- Dimensioned drawings
- Electrical connection
- Diagrams
- Operation and display
- Reflectors & reflective tapes
- Part number code
- Notes
- Accessories



Figure can vary



## Technical data

### Basic data

Series	412B
Operating principle	Reflection principle

### Optical data

Operating range	Guaranteed operating range
Operating range	0.02 ... 1.8 m, With reflector TK(S) 100x100
Operating range limit	Typical operating range
Operating range limit	0.02 ... 2.3 m, With reflector TK(S) 100x100
Light source	LED, Red
Wavelength	660 nm
Transmitted-signal shape	Pulsed
LED group	Exempt group (in acc. with EN 62471)

### Electrical data

Protective circuit	Polarity reversal protection
	Short circuit protected

### Performance data

Supply voltage $U_B$	10 ... 36 V, DC, Incl. residual ripple
Residual ripple	0 ... 20 %, From $U_B$
Open-circuit current	0 ... 15 mA

### Outputs

Number of digital switching outputs	1 Piece(s)
-------------------------------------	------------

### Switching outputs

Voltage type	DC
Switching current, max.	200 mA

### Switching output 1

Switching element	Transistor, PNP
Switching principle	Light switching

### Time behavior

Switching frequency	1,000 Hz
Response time	0.5 ms
Readiness delay	20 ms

### Connection

#### Connection 1

Function	Signal OUT
	Voltage supply
Type of connection	Connector
Thread size	M12
Type	Male
Material	Metal
No. of pins	4 -pin
Encoding	A-coded

### Mechanical data

Thread size	M12 x 1 mm
Dimension (Ø x L)	12 mm x 60 mm
Housing material	Metal
Metal housing	Chromed brass
Lens cover material	Glass
Net weight	20 g
Housing color	Silver

### Operation and display

Type of display	LED
Number of LEDs	2 Piece(s)

### Environmental data

Ambient temperature, operation	-25 ... 55 °C
--------------------------------	---------------

### Certifications

Degree of protection	IP 67
Protection class	III
Certifications	c UL US
Standards applied	IEC 60947-5-2

### Classification

Customs tariff number	85365019
ECLASS 5.1.4	27270902
ECLASS 8.0	27270902
ECLASS 9.0	27270902
ECLASS 10.0	27270902
ECLASS 11.0	27270902
ECLASS 12.0	27270902
ECLASS 13.0	27270902
ETIM 5.0	EC002717
ETIM 6.0	EC002717
ETIM 7.0	EC002717
ETIM 8.0	EC002717

# Dimensioned drawings

All dimensions in millimeters

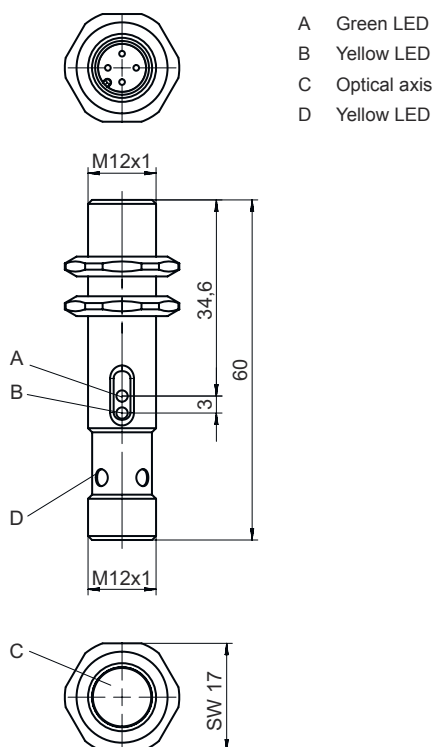

## Electrical connection

### Connection 1

<b>Function</b>	Signal OUT Voltage supply
<b>Type of connection</b>	Connector
<b>Thread size</b>	M12
<b>Type</b>	Male
<b>Material</b>	Metal
<b>No. of pins</b>	4 -pin
<b>Encoding</b>	A-coded

Pin	Pin assignment
1	V+
2	OUT 1
3	GND
4	n.c.

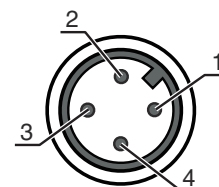

# Diagrams

## Typ. response behavior

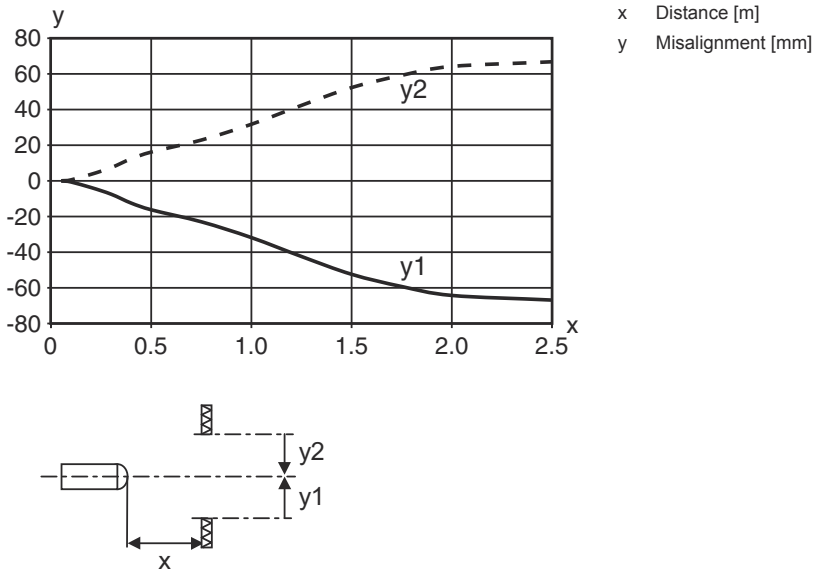

## Typ. function reserve

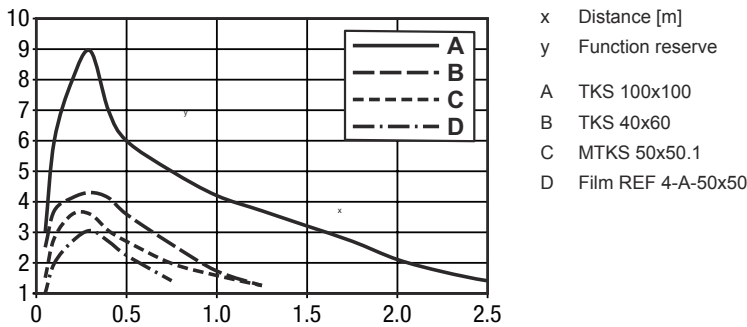

## Operation and display

LED	Display	Meaning
1	Green, continuous light	Function reserve
2	Yellow, continuous light	Switching output/switching state active

## Reflectors & reflective tapes

Part no.	Designation	Operating range Operating range limit	Description
 50117583	MTKS 50x50.1	0.015 ... 1 m 0.015 ... 1.3 m	Design: Rectangular Triple reflector size: 1.2 mm Reflective surface: 50 mm x 50 mm Material: Plastic Base material: Plastic Chemical designation of the material: PMMA8N Fastening: Through-hole mounting, Adhesive

## Reflectors & reflective tapes

	Part no.	Designation	Operating range Operating range limit	Description
	50108300	REF 4-A-50x50	0.08 ... 0.6 m 0.08 ... 0.8 m	Design: Rectangular Reflective surface: 50 mm x 50 mm Material: Plastic Chemical designation of the material: PMMA Fastening: Self-adhesive
	50024127	TK 82.2	0.05 ... 1.6 m 0.05 ... 2 m	Design: Round Triple reflector size: 4 mm Reflection surface diameter: 79 mm Material: Plastic Base material: Plastic Chemical designation of the material: PMMA8N Fastening: Through-hole mounting, Rear side can be glued
	50022816	TKS 100X100	0.02 ... 1.8 m 0.02 ... 2.3 m	Design: Rectangular Triple reflector size: 4 mm Reflective surface: 96 mm x 96 mm Material: Plastic Base material: Plastic Chemical designation of the material: PMMA8N Fastening: Through-hole mounting, Adhesive
	50081283	TKS 20X40	0.02 ... 0.5 m 0.02 ... 0.65 m	Design: Rectangular Triple reflector size: 2.3 mm Reflective surface: 16 mm x 38 mm Material: Plastic Base material: Plastic Chemical designation of the material: PMMA8N Fastening: Through-hole mounting, Adhesive
	50023525	TKS 30X50	0.02 ... 0.65 m 0.02 ... 0.85 m	Design: Rectangular Triple reflector size: 3 mm Reflective surface: 27 mm x 44 mm Material: Plastic Base material: Plastic Chemical designation of the material: PMMA8N Fastening: Through-hole mounting, Adhesive
	50040820	TKS 40X60	0.02 ... 1 m 0.02 ... 1.3 m	Design: Rectangular Triple reflector size: 4 mm Reflective surface: 37 mm x 56 mm Material: Plastic Base material: Plastic Chemical designation of the material: PMMA8N Fastening: Through-hole mounting, Adhesive

## Part number code

Part designation: AAA412BGG.H/ii-K

<b>AAA412B</b>	<b>Operating principle / construction</b> LS412B: Throughbeam photoelectric sensor transmitter LE412B: Throughbeam photoelectric sensor receiver ET412B: Energetic diffuse reflection sensor PRK412B: Retro-reflective photoelectric sensor with polarization filter
<b>GG</b>	<b>Light source</b> n/a: LED L2: laser class 2
<b>H</b>	<b>Operating range adjustment</b> 1: 270° potentiometer

## Part number code

<b>ii</b>	<b>Switching output / function / OUT1OUT2 (OUT1 = pin 2, OUT2 = pin 4)</b> 2: NPN transistor output, light switching N: NPN transistor output, dark switching 4: PNP transistor output, light switching P: PNP transistor output, dark switching D: Deactivation input (deactivation with low signal) X: pin not used
<b>K</b>	<b>Electrical connection</b> n/a: cable, standard length 2000 mm, 3-wire M12: M12 connector, 4-pin (plug)

Note	
	ⓘ A list with all available device types can be found on the Leuze website at <a href="http://www.leuze.com">www.leuze.com</a> .

## Notes

<b>Observe intended use!</b>	
	ⓘ This product is not a safety sensor and is not intended as personnel protection. ⓘ The product may only be put into operation by competent persons. ⓘ Only use the product in accordance with its intended use.

## Accessories

### Connection technology - Connection cables



	Part no.	Designation	Article	Description
	50130652	KD U-M12-4A-V1-050	Connection cable	Connection 1: Connector, M12, Axial, Female, A-coded, 4 -pin Connector, LED: No Connection 2: Open end Shielded: No Cable length: 5.000 mm Sheathing material: PVC
	50130690	KD U-M12-4W-V1-050	Connection cable	Connection 1: Connector, M12, Angled, Female, A-coded, 4 -pin Connector, LED: No Connection 2: Open end Shielded: No Cable length: 5.000 mm Sheathing material: PVC

## Accessories

### Mounting technology - Mounting brackets

	Part no.	Designation	Article	Description
	50113549	BT D12M.5	Mounting bracket	Diameter, inner: 12 mm Design of mounting device: Angle, L-shape Fastening, at system: Through-hole mounting Mounting bracket, at device: Screw type Type of mounting device: Rigid Material: Stainless steel

### Standard reflectors

	Part no.	Designation	Article	Description
	50081283	TKS 20X40	Reflector	Design: Rectangular Triple reflector size: 2.3 mm Reflective surface: 16 mm x 38 mm Material: Plastic Base material: Plastic Chemical designation of the material: PMMA8N Fastening: Through-hole mounting, Adhesive
	50040820	TKS 40X60	Reflector	Design: Rectangular Triple reflector size: 4 mm Reflective surface: 37 mm x 56 mm Material: Plastic Base material: Plastic Chemical designation of the material: PMMA8N Fastening: Through-hole mounting, Adhesive

### Reflective tapes for standard applications

	Part no.	Designation	Article	Description
	50108300	REF 4-A-50x50	Reflective tape	Design: Rectangular Reflective surface: 50 mm x 50 mm Material: Plastic Chemical designation of the material: PMMA Fastening: Self-adhesive

#### Note



A list with all available accessories can be found on the Leuze website in the Download tab of the article detailed page.