

## Technical data sheet

### Polarized retro-reflective photoelectric sensor

Part no.: 50140149

PRK412B/N

#### Contents

- Technical data
- Dimensioned drawings
- Electrical connection
- Diagrams
- Operation and display
- Reflectors & reflective tapes
- Part number code
- Notes
- Accessories



Figure can vary



## Technical data

### Basic data

|                     |                      |
|---------------------|----------------------|
| Series              | 412B                 |
| Operating principle | Reflection principle |

### Optical data

|                          |   |
|--------------------------|---|
| Operating range          | Guaranteed operating range                      |
| Operating range          | 0.02 ... 1.8 m, With reflector TK(S)<br>100x100 |
| Operating range limit    | Typical operating range                         |
| Operating range limit    | 0.02 ... 2.3 m, With reflector TK(S)<br>100x100 |
| Light source             | LED, Red  |
| Wavelength               | 660 nm  |
| Transmitted-signal shape | Pulsed  |
| LED group                | Exempt group (in acc. with EN 62471)            |

### Electrical data

|                    |                              |
|--------------------|------------------------------|
| Protective circuit | Polarity reversal protection |
|                    | Short circuit protected      |

### Performance data

|                      |  |
|----------------------|--|
| Supply voltage $U_B$ | 10 ... 36 V, DC, Incl. residual ripple |
| Residual ripple      | 0 ... 20 %, From $U_B$                 |
| Open-circuit current | 0 ... 15 mA                            |

### Outputs

|                                     |            |
|-------------------------------------|------------|
| Number of digital switching outputs | 1 Piece(s) |
|-------------------------------------|------------|

### Switching outputs

|                         |        |
|-------------------------|--------|
| Voltage type            | DC     |
| Switching current, max. | 200 mA |

### Switching output 1

|                     |                 |
|---------------------|-----------------|
| Switching element   | Transistor, NPN |
| Switching principle | Dark switching  |

### Time behavior

|                     |          |
|---------------------|----------|
| Switching frequency | 1,000 Hz |
| Response time       | 0.5 ms   |
| Readiness delay     | 20 ms    |

### Connection

#### Connection 1

|                      |                      |
|----------------------|----------------------|
| Function             | Signal OUT           |
|                      | Voltage supply       |
| Type of connection   | Cable                |
| Cable length         | 2,000 mm             |
| Sheathing material   | PVC                  |
| Cable color          | Black                |
| Number of conductors | 3 -wire              |
| Wire cross section   | 0.34 mm <sup>2</sup> |

### Mechanical data

|                     |               |
|---------------------|---------------|
| Thread size         | M12 x 1 mm    |
| Dimension (Ø x L)   | 12 mm x 51 mm |
| Housing material    | Metal         |
| Metal housing       | Chromed brass |
| Lens cover material | Glass         |
| Net weight          | 100 g         |
| Housing color       | Silver        |

### Operation and display

|                 |            |
|-----------------|------------|
| Type of display | LED        |
| Number of LEDs  | 2 Piece(s) |

### Environmental data

|                                |               |
|--------------------------------|---------------|
| Ambient temperature, operation | -25 ... 55 °C |
|--------------------------------|---------------|

### Certifications

|                      |               |
|----------------------|---------------|
| Degree of protection | IP 67         |
| Protection class     | III           |
| Certifications       | c UL US       |
| Standards applied    | IEC 60947-5-2 |

### Classification

|                       |          |
|-----------------------|----------|
| Customs tariff number | 85365019 |
| ECLASS 5.1.4          | 27270902 |
| ECLASS 8.0            | 27270902 |
| ECLASS 9.0            | 27270902 |
| ECLASS 10.0           | 27270902 |
| ECLASS 11.0           | 27270902 |
| ECLASS 12.0           | 27270902 |
| ECLASS 13.0           | 27270902 |
| ETIM 5.0              | EC002717 |
| ETIM 6.0              | EC002717 |
| ETIM 7.0              | EC002717 |
| ETIM 8.0              | EC002717 |

## Dimensioned drawings

All dimensions in millimeters

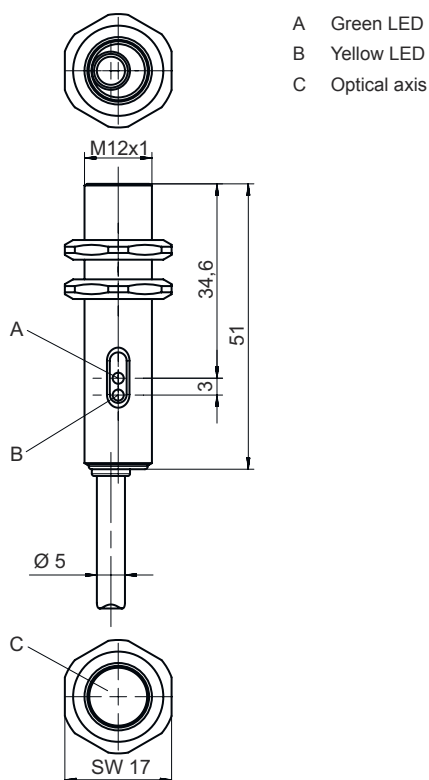

## Electrical connection

### Connection 1

|                      |                      |
|----------------------|----------------------|
| Function             | Signal OUT           |
|                      | Voltage supply       |
| Type of connection   | Cable                |
| Cable length         | 2,000 mm             |
| Sheathing material   | PVC                  |
| Cable color          | Black                |
| Number of conductors | 3 -wire              |
| Wire cross section   | 0.34 mm <sup>2</sup> |

### Conductor color

### Conductor assignment

|       |       |
|-------|-------|
| Brown | V+    |
| Black | OUT 1 |
| Blue  | GND   |

## Diagrams

### Typ. response behavior

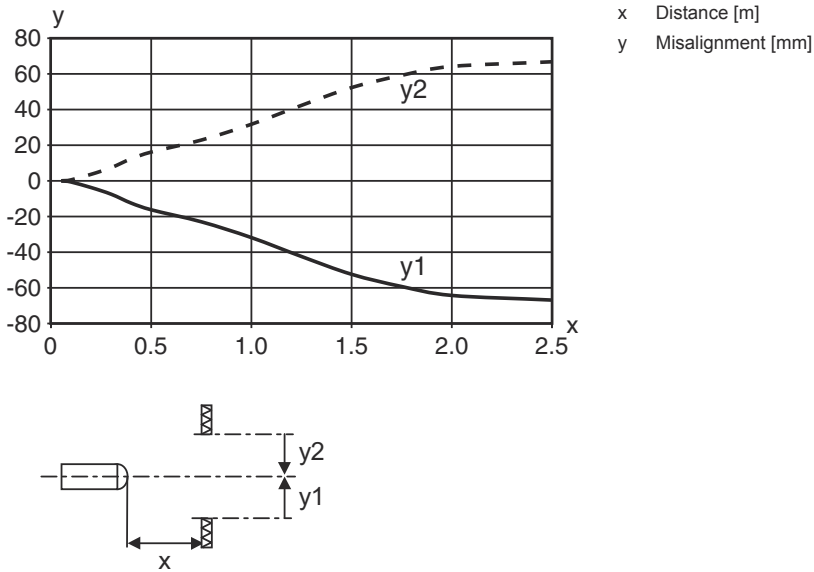

### Typ. function reserve

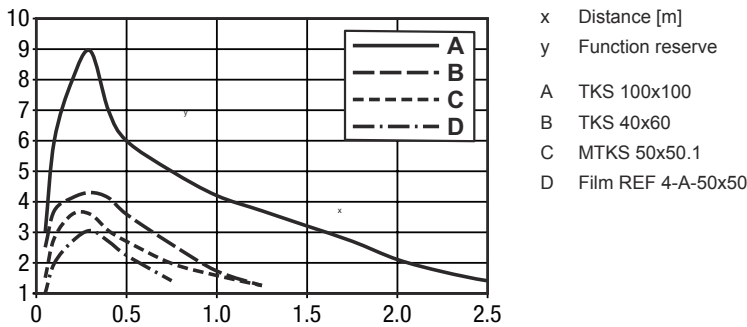

## Operation and display

| LED | Display                  | Meaning                                 |
|-----|--------------------------|---|
| 1   | Green, continuous light  | Function reserve                        |
| 2   | Yellow, continuous light | Switching output/switching state active |

## Reflectors & reflective tapes

| Part no.   | Designation  | Operating range<br>Operating range<br>limit | Description  |
|--|--------------|---|--|
|  50117583 | MTKS 50x50.1 | 0.015 ... 1 m<br>0.015 ... 1.3 m            | Design: Rectangular<br>Triple reflector size: 1.2 mm<br>Reflective surface: 50 mm x 50 mm<br>Material: Plastic<br>Base material: Plastic<br>Chemical designation of the material: PMMA8N<br>Fastening: Through-hole mounting, Adhesive |

## Reflectors & reflective tapes

|   | Part no. | Designation   | Operating range<br>Operating range<br>limit | Description   |
|---|----------|---------------|---|---|
|    | 50108300 | REF 4-A-50x50 | 0.08 ... 0.6 m<br>0.08 ... 0.8 m            | Design: Rectangular<br>Reflective surface: 50 mm x 50 mm<br>Material: Plastic<br>Chemical designation of the material: PMMA<br>Fastening: Self-adhesive   |
|    | 50024127 | TK 82.2       | 0.05 ... 1.6 m<br>0.05 ... 2 m              | Design: Round<br>Triple reflector size: 4 mm<br>Reflection surface diameter: 79 mm<br>Material: Plastic<br>Base material: Plastic<br>Chemical designation of the material: PMMA8N<br>Fastening: Through-hole mounting, Rear side can be glued |
|    | 50022816 | TKS 100X100   | 0.02 ... 1.8 m<br>0.02 ... 2.3 m            | Design: Rectangular<br>Triple reflector size: 4 mm<br>Reflective surface: 96 mm x 96 mm<br>Material: Plastic<br>Base material: Plastic<br>Chemical designation of the material: PMMA8N<br>Fastening: Through-hole mounting, Adhesive          |
|   | 50081283 | TKS 20X40     | 0.02 ... 0.5 m<br>0.02 ... 0.65 m           | Design: Rectangular<br>Triple reflector size: 2.3 mm<br>Reflective surface: 16 mm x 38 mm<br>Material: Plastic<br>Base material: Plastic<br>Chemical designation of the material: PMMA8N<br>Fastening: Through-hole mounting, Adhesive        |
|  | 50023525 | TKS 30X50     | 0.02 ... 0.65 m<br>0.02 ... 0.85 m          | Design: Rectangular<br>Triple reflector size: 3 mm<br>Reflective surface: 27 mm x 44 mm<br>Material: Plastic<br>Base material: Plastic<br>Chemical designation of the material: PMMA8N<br>Fastening: Through-hole mounting, Adhesive          |
|  | 50040820 | TKS 40X60     | 0.02 ... 1 m<br>0.02 ... 1.3 m              | Design: Rectangular<br>Triple reflector size: 4 mm<br>Reflective surface: 37 mm x 56 mm<br>Material: Plastic<br>Base material: Plastic<br>Chemical designation of the material: PMMA8N<br>Fastening: Through-hole mounting, Adhesive          |

## Part number code

Part designation: AAA412BGG.H/ii-K

|                |  |
|----------------|--|
| <b>AAA412B</b> | <b>Operating principle / construction</b><br>LS412B: Throughbeam photoelectric sensor transmitter<br>LE412B: Throughbeam photoelectric sensor receiver<br>ET412B: Energetic diffuse reflection sensor<br>PRK412B: Retro-reflective photoelectric sensor with polarization filter |
| <b>GG</b>      | <b>Light source</b><br>n/a: LED<br>L2: laser class 2   |
| <b>H</b>       | <b>Operating range adjustment</b><br>1: 270° potentiometer   |

## Part number code

|    |   |
|----|---|
| ii | <b>Switching output / function / OUT1OUT2 (OUT1 = pin 4, OUT2 = pin 2)</b><br>2: NPN transistor output, light switching<br>N: NPN transistor output, dark switching<br>4: PNP transistor output, light switching<br>P: PNP transistor output, dark switching<br>D: Deactivation input (deactivation with low signal)<br>X: pin not used |
| K  | <b>Electrical connection</b><br>n/a: cable, standard length 2000 mm, 3-wire<br>M12: M12 connector, 4-pin (plug)   |

### Note

|  |  |
|--|--|
|  | ↪ A list with all available device types can be found on the Leuze website at <a href="http://www.leuze.com">www.leuze.com</a> . |
|--|--|

## Notes

### Observe intended use!

|   |   |
|---|---|
|  | ↪ This product is not a safety sensor and is not intended as personnel protection.<br>↪ The product may only be put into operation by competent persons.<br>↪ Only use the product in accordance with its intended use. |
|---|---|

## Accessories

### Mounting technology - Mounting brackets

|  | Part no. | Designation | Article          | Description  |
|--|----------|-------------|------------------|--|
|  | 50113549 | BT D12M.5   | Mounting bracket | Diameter, inner: 12 mm<br>Design of mounting device: Angle, L-shape<br>Fastening, at system: Through-hole mounting<br>Mounting bracket, at device: Screw type<br>Type of mounting device: Rigid<br>Material: Stainless steel |

### Standard reflectors

|   | Part no. | Designation | Article   | Description  |
|---|----------|-------------|-----------|--|
|  | 50081283 | TKS 20X40   | Reflector | Design: Rectangular<br>Triple reflector size: 2.3 mm<br>Reflective surface: 16 mm x 38 mm<br>Material: Plastic<br>Base material: Plastic<br>Chemical designation of the material: PMMA8N<br>Fastening: Through-hole mounting, Adhesive |

## Accessories

|   | Part no. | Designation | Article   | Description  |
|---|----------|-------------|-----------|--|
|  | 50040820 | TKS 40X60   | Reflector | Design: Rectangular<br>Triple reflector size: 4 mm<br>Reflective surface: 37 mm x 56 mm<br>Material: Plastic<br>Base material: Plastic<br>Chemical designation of the material: PMMA8N<br>Fastening: Through-hole mounting, Adhesive |

## Reflective tapes for standard applications

|   | Part no. | Designation   | Article         | Description   |
|---|----------|---------------|-----------------|---|
|  | 50108300 | REF 4-A-50x50 | Reflective tape | Design: Rectangular<br>Reflective surface: 50 mm x 50 mm<br>Material: Plastic<br>Chemical designation of the material: PMMA<br>Fastening: Self-adhesive |

### Note



↪ A list with all available accessories can be found on the Leuze website in the Download tab of the article detailed page.