

## Technical data sheet

### Polarized retro-reflective photoelectric sensor

Part no.: 50127423

PRK49C.UC1/M4-TB



Figure can vary

#### Contents

- Technical data
- Dimensioned drawings
- Electrical connection
- Circuit diagrams
- Diagrams
- Operation and display
- Reflectors & reflective tapes
- Part number code
- Notes
- Further information
- Accessories



## Technical data

### Basic data

Series	49C
Operating principle	Reflection principle

### Optical data

Operating range	Guaranteed operating range
Operating range	0.3 ... 24 m, With reflector TK(S) 100x100
Operating range limit	Typical operating range
Operating range limit	0.1 ... 30 m, With reflector TK(S) 100x100
Beam path	Divergent
Light source	LED, Red
Wavelength	630 nm
Transmitted-signal shape	Pulsed
LED group	Exempt group (in acc. with EN 62471)
Light spot size [at sensor distance]	130 mm [6,000 mm]
Type of light spot geometry	Round

### Electrical data

Protective circuit	Interference blanking
	Transient protection

### Performance data

Supply voltage $U_B$	20 ... 250 V, AC/DC
Power consumption (with AC)	1.5 V·A

### Outputs

Number of digital switching outputs	1 Piece(s)
-------------------------------------	------------

### Switching outputs

Voltage type	AC/DC
Switching current, max.	400 mA
Switching power	100 V·A
Switching voltage	250 V AC/DC

### Switching output 1

Assignment	Connection 1, pin 4
Switching element	MOSFET semiconductor, NO (normally open)
Switching principle	Light/dark switchable

### Time behavior

Switching frequency	150 Hz
Response time	3.3 ms
Readiness delay	300 ms

### Connection

#### Connection 1

Function	Signal OUT
	Voltage supply
Type of connection	Terminal
Type of terminal	Spring-cage terminal
No. of pins	5 -pin

### Mechanical data

Dimension (W x H x L)	31 mm x 104 mm x 55.5 mm
Housing material	Plastic
Plastic housing	PC
Lens cover material	Plastic
Net weight	150 g
Housing color	Red
Type of fastening	Through-hole mounting Via optional mounting device

### Operation and display

Type of display	LED
Number of LEDs	2 Piece(s)
Operational controls	270° potentiometer Teach button
Function of the operational control	Activation of the time module for dropout delay
	Light/dark switching
	Sensitivity adjustment

### Environmental data

Ambient temperature, operation	-40 ... 60 °C
Ambient temperature, storage	-40 ... 70 °C

### Certifications

Degree of protection	IP 67
Protection class	II
Certifications	c UL US
Standards applied	IEC 60947-5-2

### Classification

Customs tariff number	85365080
ECLASS 5.1.4	27270902
ECLASS 8.0	27270902
ECLASS 9.0	27270902
ECLASS 10.0	27270902
ECLASS 11.0	27270902
ECLASS 12.0	27270902
ECLASS 13.0	27270902
ETIM 5.0	EC002717
ETIM 6.0	EC002717
ETIM 7.0	EC002717
ETIM 8.0	EC002717

# Dimensioned drawings

All dimensions in millimeters

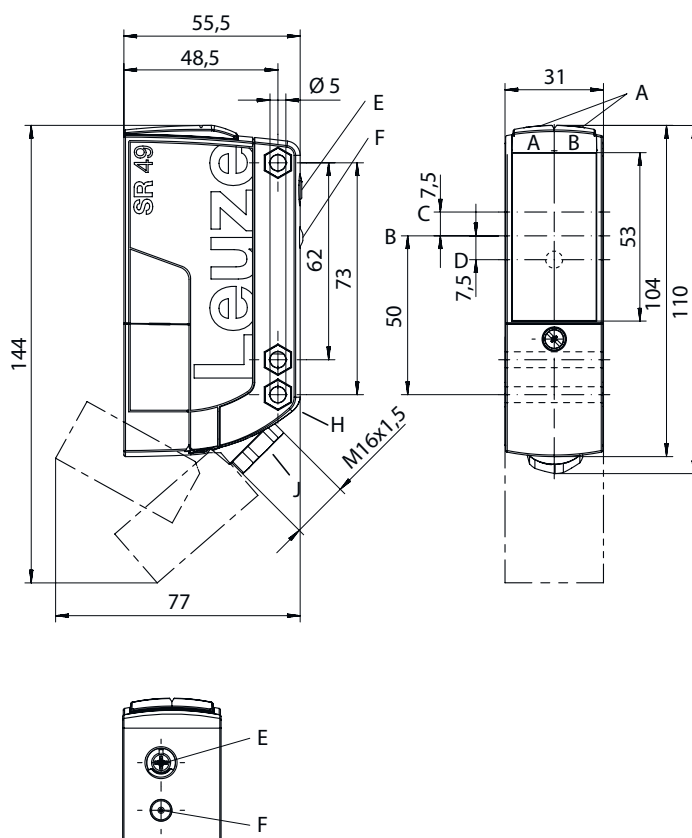

- AA Green LED
- AB Yellow LED
- B Optical axis
- C Receiver
- D Transmitter
- E Sensitivity adjustment
- F Teach button
- H Countersinking for SK nut M5, 4.2 mm deep
- J Cable entry with M16x 1.5 screw fitting for Ø5 ... 10 mm

## Electrical connection

### Connection 1

Function	Signal OUT
	Voltage supply
Type of connection	Terminal
Type of terminal	Spring-cage terminal
No. of pins	5 -pin

Terminal	Assignment
1	+ / L1
2	- / N
3	n.c.
4	OUT 1
5	COM

# Circuit diagrams

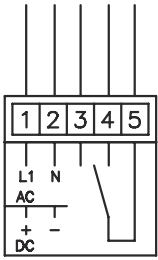

## Diagrams

Typ. response behavior (TKS100x100)

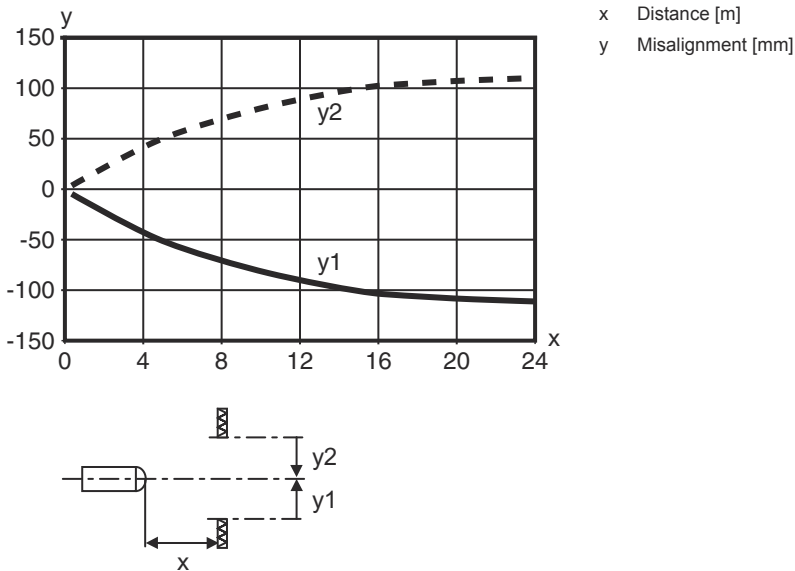

Typ. function reserve

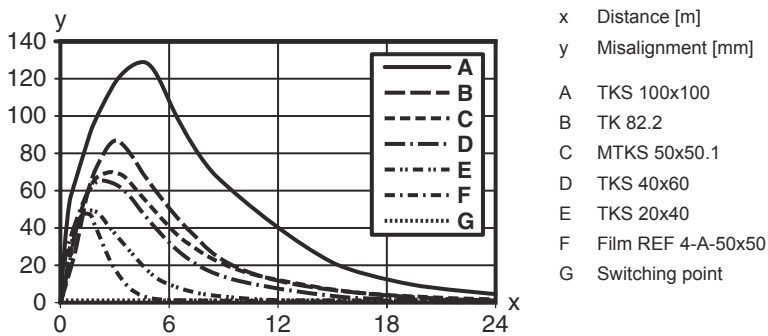

## Operation and display

LED	Display	Meaning
1	Green, continuous light	Operational readiness
2	Yellow, continuous light	Light path free

## Operation and display

LED	Display	Meaning
2	Yellow, flashing	Light path free, no function reserve

## Reflectors & reflective tapes

	Part no.	Designation	Operating range Operating range limit	Description
	50117583	MTKS 50x50.1	0.3 ... 15 m 0.1 ... 18 m	Design: Rectangular Triple reflector size: 1.2 mm Reflective surface: 50 mm x 50 mm Material: Plastic Base material: Plastic Chemical designation of the material: PMMA8N Fastening: Through-hole mounting, Adhesive
	50108300	REF 4-A-50x50	0.3 ... 4 m 0.1 ... 5 m	Design: Rectangular Reflective surface: 50 mm x 50 mm Material: Plastic Chemical designation of the material: PMMA Fastening: Self-adhesive
	50003192	TK 100x100	0.3 ... 24 m 0.1 ... 30 m	Design: Rectangular Triple reflector size: 4 mm Reflective surface: 96 mm x 96 mm Material: Plastic Base material: Plastic Chemical designation of the material: PMMA8N Fastening: Rear side can be glued
	50003189	TK 30x50	0.3 ... 12 m 0.1 ... 15 m	Design: Rectangular Triple reflector size: 4 mm Reflective surface: 29 mm x 45 mm Material: Plastic Base material: Plastic Chemical designation of the material: PMMA8N Fastening: Rear side can be glued
	50024127	TK 82.2	0.3 ... 15 m 0.1 ... 18 m	Design: Round Triple reflector size: 4 mm Reflection surface diameter: 79 mm Material: Plastic Base material: Plastic Chemical designation of the material: PMMA8N Fastening: Through-hole mounting, Rear side can be glued
	50022816	TKS 100X100	0.3 ... 24 m 0.1 ... 30 m	Design: Rectangular Triple reflector size: 4 mm Reflective surface: 96 mm x 96 mm Material: Plastic Base material: Plastic Chemical designation of the material: PMMA8N Fastening: Through-hole mounting, Adhesive
	50081283	TKS 20X40	0.3 ... 8 m 0.1 ... 10 m	Design: Rectangular Triple reflector size: 2.3 mm Reflective surface: 16 mm x 38 mm Material: Plastic Base material: Plastic Chemical designation of the material: PMMA8N Fastening: Through-hole mounting, Adhesive

## Reflectors & reflective tapes

	Part no.	Designation	Operating range Operating range limit	Description
	50023525	TKS 30X50	0.3 ... 12 m 0.1 ... 15 m	Design: Rectangular Triple reflector size: 3 mm Reflective surface: 27 mm x 44 mm Material: Plastic Base material: Plastic Chemical designation of the material: PMMA8N Fastening: Through-hole mounting, Adhesive

## Part number code

Part designation: **AAA49Cd.EEfG/iJ-KL**

<b>AAA49C</b>	<b>Operating principle / construction</b> PRK49C: Retro-reflective photoelectric sensor with polarization filter HT49C: Diffuse reflection sensor with background suppression LS49C: Throughbeam photoelectric sensor transmitter LE49C: Throughbeam photoelectric sensor receiver
<b>d</b>	<b>Light type</b> n/a: red light l: infrared light
<b>EE</b>	<b>Operating voltage</b> n/a: 10 ... 30 V, DC UC: 20 ... 250V AC/DC (all-mains design)
<b>f</b>	<b>Equipment</b> H: With heating D: Depolarizing media 1: 270° potentiometer 8: activation input (activation with high signal)
<b>iJ</b>	<b>Switching output / Function / OUT1OUT2</b> 2: NPN transistor output, light switching N: NPN transistor output, dark switching 4: PNP transistor output, light switching P: PNP transistor output, dark switching W: warning output TS: Relay, NC contact/NO contact M4: Low impedance MOSFET semiconductor switching output, NO contact
<b>KL</b>	<b>Electrical connection</b> TB: Terminal block - terminal compartment with spring terminals (5 x 1.5mm <sup>2</sup> ) n/a: cable, standard length 2000 mm

### Note



↪ A list with all available device types can be found on the Leuze website at [www.leuze.com](http://www.leuze.com).

## Notes



### Observe intended use!



- ↪ This product is not a safety sensor and is not intended as personnel protection.
- ↪ The product may only be put into operation by competent persons.
- ↪ Only use the product in accordance with its intended use.

## Further information

- All-insulated, rating voltage 250 VAC
- With inductive or capacitive load, provide suitable spark extinction (snubber)

## Accessories



### Mounting technology - Mounting brackets

	Part no.	Designation	Article	Description
	50025570	BT 96	Mounting device	Design of mounting device: Angle, L-shape Fastening, at system: Through-hole mounting Mounting bracket, at device: Screw type Type of mounting device: Rigid Material: Metal

### Mounting technology - Rod mounts

	Part no.	Designation	Article	Description
	50128380	BTU 460M-D12	Mounting system	Design of mounting device: Mounting system Fastening, at system: For 12 mm rod Mounting bracket, at device: Screw type Type of mounting device: Adjustable, Turning, 360° Material: Metal

## Standard reflectors

	Part no.	Designation	Article	Description
	50024127	TK 82.2	Reflector	Design: Round Triple reflector size: 4 mm Reflection surface diameter: 79 mm Material: Plastic Base material: Plastic Chemical designation of the material: PMMA8N Fastening: Through-hole mounting, Rear side can be glued
	50022816	TKS 100X100	Reflector	Design: Rectangular Triple reflector size: 4 mm Reflective surface: 96 mm x 96 mm Material: Plastic Base material: Plastic Chemical designation of the material: PMMA8N Fastening: Through-hole mounting, Adhesive

#### Note



A list with all available accessories can be found on the Leuze website in the Download tab of the article detailed page.