

Technical data sheet

Polarized retro-reflective photoelectric sensor

Part no.: 50127427

PRK49C.UCD1/TS



Figure can vary

Contents

- Technical data
- Dimensioned drawings
- Electrical connection
- Circuit diagrams
- Diagrams
- Operation and display
- Reflectors & reflective tapes
- Part number code
- Notes
- Further information
- Accessories



Technical data

Basic data

Series	49C
Operating principle	Reflection principle
Application	Detection of bottle container Detection of transparent films

Optical data

Operating range	Guaranteed operating range
Operating range	0.1 ... 16 m, With reflector TK(S) 100x100
Operating range limit	Typical operating range
Operating range limit	0.1 ... 20 m, With reflector TK(S) 100x100
Beam path	Divergent
Light source	LED, Red
Wavelength	630 nm
Transmitted-signal shape	Pulsed
LED group	Exempt group (in acc. with EN 62471)
Light spot size [at sensor distance]	130 mm [6,000 mm]
Type of light spot geometry	Round

Electrical data

Protective circuit	Interference blanking Transient protection
--------------------	---

Performance data

Supply voltage U_B	20 ... 250 V, AC/DC
Power consumption (with AC)	1.5 V·A

Outputs

Number of digital switching outputs	2 Piece(s)
-------------------------------------	------------

Switching outputs

Voltage type	AC/DC
Switching current, max.	2,500 mA
Switching voltage	250 V AC/DC

Switching output 1

Switching element	Relay, NC
Switching principle	Light/dark switchable

Switching output 2

Switching element	Relay, NO
Switching principle	Light/dark switchable

Time behavior

Switching frequency	25 Hz
Response time	20 ms
Readiness delay	300 ms

Connection

Connection 1

Function	Signal OUT Voltage supply
Type of connection	Cable
Cable length	2,000 mm
Sheathing material	PVC
Cable color	Black
Number of conductors	5 -wire
Wire cross section	0.34 mm ²

Mechanical data

Dimension (W x H x L)	31 mm x 104 mm x 55.5 mm
Housing material	Plastic
Plastic housing	PC
Lens cover material	Plastic
Net weight	150 g
Housing color	Red
Type of fastening	Through-hole mounting Via optional mounting device

Operation and display

Type of display	LED
Number of LEDs	2 Piece(s)
Operational controls	270° potentiometer Teach button
Function of the operational control	Activation of the time module for dropout delay Light/dark switching Sensitivity adjustment

Environmental data

Ambient temperature, operation	-40 ... 60 °C
Ambient temperature, storage	-40 ... 70 °C

Certifications

Degree of protection	IP 67
Protection class	II
Certifications	c UL US
Standards applied	IEC 60947-5-2

Classification

Customs tariff number	85365080
ECLASS 5.1.4	27270902
ECLASS 8.0	27270902
ECLASS 9.0	27270902
ECLASS 10.0	27270902
ECLASS 11.0	27270902
ECLASS 12.0	27270902
ECLASS 13.0	27270902
ETIM 5.0	EC002717
ETIM 6.0	EC002717
ETIM 7.0	EC002717
ETIM 8.0	EC002717

Dimensioned drawings

All dimensions in millimeters

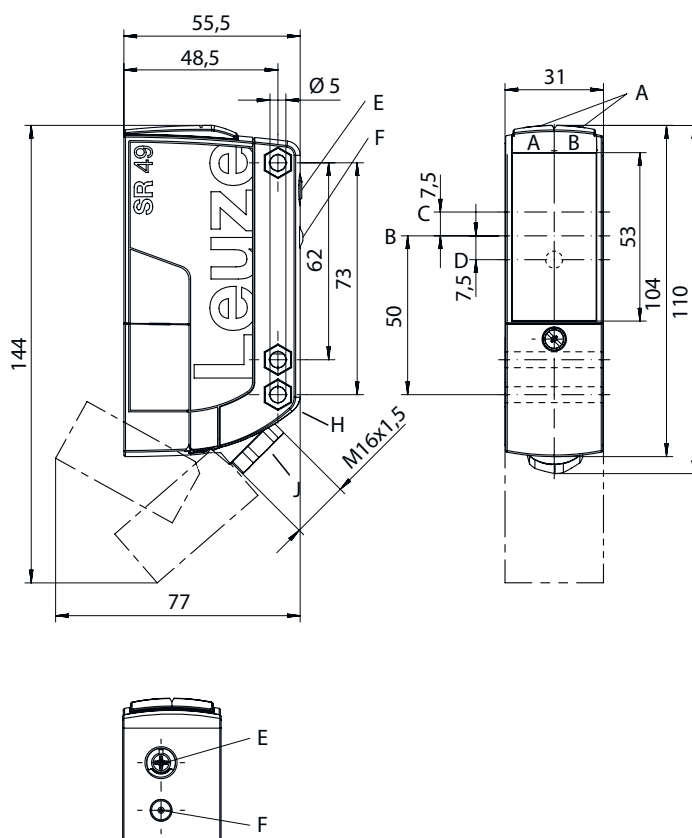

- AA Green LED
- AB Yellow LED
- B Optical axis
- C Receiver
- D Transmitter
- E Sensitivity adjustment
- F Teach button
- H Countersinking for SK nut M5, 4.2 mm deep
- J Cable entry with M16x1.5 screw fitting for Ø5 ... 10 mm

Electrical connection

Connection 1

Function	Signal OUT
	Voltage supply
Type of connection	Cable
Cable length	2,000 mm
Sheathing material	PVC
Cable color	Black
Number of conductors	5 -wire
Wire cross section	0.34 mm ²

Conductor color

Conductor assignment

Brown	+ / L1
Blue	- / N
White	OUT 1
Gray	COM
Black	OUT 2

Circuit diagrams

AC



DC

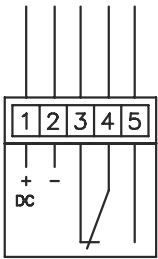

Diagrams

Typ. response behavior (TKS100x100)

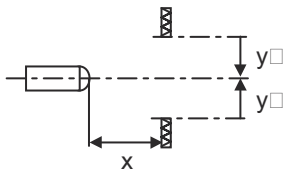
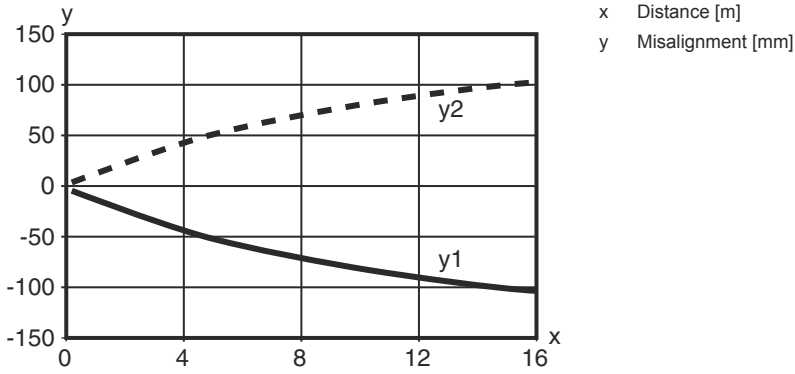

Diagrams

Typ. function reserve

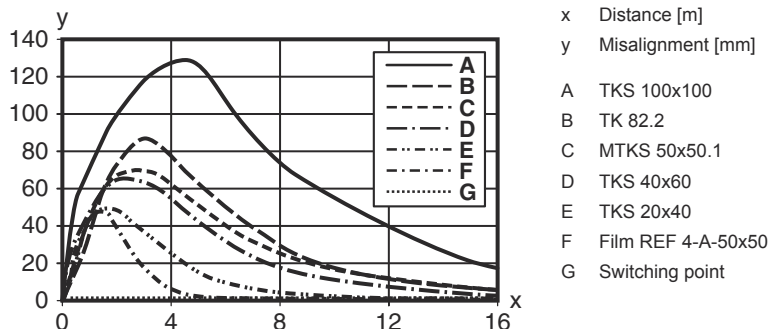





Operation and display

LED	Display	Meaning
1	Green, continuous light	Operational readiness
2	Yellow, continuous light	Light path free
	Yellow, flashing	Light path free, no function reserve

Reflectors & reflective tapes

	Part no.	Designation	Operating range Operating range limit	Description
	50117583	MTKS 50x50.1	0.3 ... 15 m 0.1 ... 18 m	Design: Rectangular Triple reflector size: 1.2 mm Reflective surface: 50 mm x 50 mm Material: Plastic Base material: Plastic Chemical designation of the material: PMMA8N Fastening: Through-hole mounting, Adhesive
	50108300	REF 4-A-50x50	0.3 ... 4 m 0.1 ... 5 m	Design: Rectangular Reflective surface: 50 mm x 50 mm Material: Plastic Chemical designation of the material: PMMA Fastening: Self-adhesive
	50003192	TK 100x100	0.3 ... 24 m 0.1 ... 30 m	Design: Rectangular Triple reflector size: 4 mm Reflective surface: 96 mm x 96 mm Material: Plastic Base material: Plastic Chemical designation of the material: PMMA8N Fastening: Rear side can be glued
	50003189	TK 30x50	0.3 ... 12 m 0.1 ... 15 m	Design: Rectangular Triple reflector size: 4 mm Reflective surface: 29 mm x 45 mm Material: Plastic Base material: Plastic Chemical designation of the material: PMMA8N Fastening: Rear side can be glued

Reflectors & reflective tapes

	Part no.	Designation	Operating range Operating range limit	Description
	50024127	TK 82.2	0.3 ... 15 m 0.1 ... 18 m	Design: Round Triple reflector size: 4 mm Reflection surface diameter: 79 mm Material: Plastic Base material: Plastic Chemical designation of the material: PMMA8N Fastening: Through-hole mounting, Rear side can be glued
	50022816	TKS 100X100	0.3 ... 24 m 0.1 ... 30 m	Design: Rectangular Triple reflector size: 4 mm Reflective surface: 96 mm x 96 mm Material: Plastic Base material: Plastic Chemical designation of the material: PMMA8N Fastening: Through-hole mounting, Adhesive
	50081283	TKS 20X40	0.3 ... 8 m 0.1 ... 10 m	Design: Rectangular Triple reflector size: 2.3 mm Reflective surface: 16 mm x 38 mm Material: Plastic Base material: Plastic Chemical designation of the material: PMMA8N Fastening: Through-hole mounting, Adhesive
	50023525	TKS 30X50	0.3 ... 12 m 0.1 ... 15 m	Design: Rectangular Triple reflector size: 3 mm Reflective surface: 27 mm x 44 mm Material: Plastic Base material: Plastic Chemical designation of the material: PMMA8N Fastening: Through-hole mounting, Adhesive

Part number code

Part designation: AAA49Cd.EEfG/iJ-KL

AAA49C	Operating principle / construction PRK49C: Retro-reflective photoelectric sensor with polarization filter HT49C: Diffuse reflection sensor with background suppression LS49C: Throughbeam photoelectric sensor transmitter LE49C: Throughbeam photoelectric sensor receiver
d	Light type n/a: red light l: infrared light
EE	Operating voltage n/a: 10 ... 30 V, DC UC: 20 ... 250V AC/DC (all-mains design)
f	Equipment H: With heating D: Depolarizing media 1: 270° potentiometer 8: activation input (activation with high signal)



Part number code

iJ	Switching output / Function / OUT1OUT2 2: NPN transistor output, light switching N: NPN transistor output, dark switching 4: PNP transistor output, light switching P: PNP transistor output, dark switching W: warning output TS: Relay, NC contact/NO contact M4: Low impedance MOSFET semiconductor switching output, NO contact
KL	Electrical connection TB: Terminal block - terminal compartment with spring terminals (5 x 1.5mm ²) n/a: cable, standard length 2000 mm

Note

	ⓘ A list with all available device types can be found on the Leuze website at www.leuze.com .
--	--

Notes

 Observe intended use!	
	ⓘ This product is not a safety sensor and is not intended as personnel protection. ⓘ The product may only be put into operation by competent persons. ⓘ Only use the product in accordance with its intended use.

Further information

- All-insulated, rating voltage 250 VAC
- With inductive or capacitive load, provide suitable spark extinction (snubber)

Accessories

Mounting technology - Mounting brackets



	Part no.	Designation	Article	Description
	50025570	BT 96	Mounting device	Design of mounting device: Angle, L-shape Fastening, at system: Through-hole mounting Mounting bracket, at device: Screw type Type of mounting device: Rigid Material: Metal

Accessories

Mounting technology - Rod mounts

	Part no.	Designation	Article	Description
	50128380	BTU 460M-D12	Mounting system	Design of mounting device: Mounting system Fastening, at system: For 12 mm rod Mounting bracket, at device: Screw type Type of mounting device: Adjustable, Turning, 360° Material: Metal

Standard reflectors

	Part no.	Designation	Article	Description
	50024127	TK 82.2	Reflector	Design: Round Triple reflector size: 4 mm Reflection surface diameter: 79 mm Material: Plastic Base material: Plastic Chemical designation of the material: PMMA8N Fastening: Through-hole mounting, Rear side can be glued
	50022816	TKS 100X100	Reflector	Design: Rectangular Triple reflector size: 4 mm Reflective surface: 96 mm x 96 mm Material: Plastic Base material: Plastic Chemical designation of the material: PMMA8N Fastening: Through-hole mounting, Adhesive

Note



A list with all available accessories can be found on the Leuze website in the Download tab of the article detailed page.