

HTU418B

STANDARD ultrasonic sensors with 1 switching output

en 09-2017/09 50124878-01



Dimensioned drawing

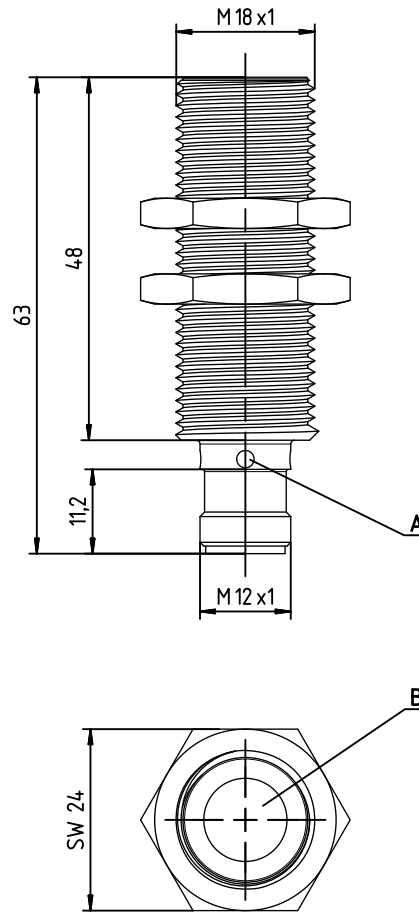

- A Indicator diodes
- B Active sensor surface



25 ... 400mm
100 ... 700mm
150 ... 1000mm



- Largely surface-independent function, ideal for the detection of liquids, bulk materials, transparent media, ...
- Small dead zone at long range
- Adjustment of the switching point can be taught
- NO/NC function reversible
- 1 switching output (PNP)
- Extra short construction
- **NEW** – Stable all-metal design

Electrical connection

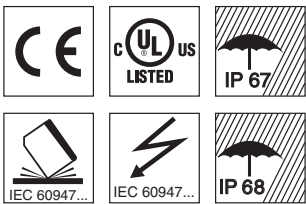
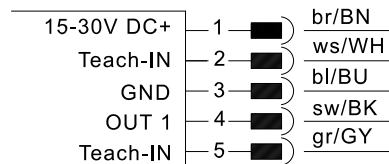

Accessories:

(available separately)

- Mounting systems
- Mounting adapter M18-M30: BTX-D18M-D30 (Part no. 50125860)
- Cables with M12 connector (KD ...)
- Teach adapter PA1/XTSX-M12 (Part no. 50124709)

We reserve the right to make changes • PAL_HTU418B4TX_en_50124878_01.fm

Specifications

Ultrasonic specifications	HTU418B-400/4TX...	HTU418B-700/4TX...	HTU418B-1000/4TX...
Scanning range ¹⁾	25 ... 400mm ²⁾	100 ... 700mm ³⁾	150 ... 1000mm ⁴⁾
Adjustment range	25 ... 400mm	100 ... 700mm	150 ... 1000mm
Ultrasonic frequency	310kHz	200kHz	200kHz
Typ. opening angle	9°	16°	16°
Resolution switching output	0.5mm	1mm	1mm
Direction of beam	axial	axial	axial
Reproducibility	± 0.15% ^{1) 5)}	± 0.15% ^{1) 5)}	± 0.15% ^{1) 5)}
Switching hysteresis	5mm ¹⁾	10mm ¹⁾	10mm ¹⁾
Temperature drift	0.17%/K	0.17%/K	0.17%/K

Timing	7Hz	8Hz	8Hz
Switching frequency	7Hz	8Hz	8Hz
Response time	71ms	62ms	62ms
Delay before start-up	< 300ms	< 300ms	< 300ms

Electrical data	15 ... 30V DC (incl. ± 10% residual ripple)
Operating voltage U_B ⁶⁾	15 ... 30V DC (incl. ± 10% residual ripple)
Residual ripple	± 10% of U_B
Open-circuit current	≤ 50mA
Switching output	1 x PNP transistor
Function	NO contact, reversible
Output current	max. 150mA
Switching range adjustment	teach-in (Pin 2): for OUT1: connected to GND for 2 ... 7s teach-in (pin 2): for OUT1: connected to U_B for 2 ... 7s

Changeover NO/NC ⁷⁾

Indicators	OUT1: object detected
Yellow LED	teach-in / teaching error
Yellow LED, flashing	object within scanning range
Green LED	

Mechanical data	all-metal brass, nickel-plated
Housing	all-metal brass, nickel-plated
Weight	50g
Ultrasonic transducer	piezoceramic ⁸⁾
Connection type	M12 connector, 5-pin
Fitting position	any

Environmental data	-25°C ... +70°C/-30°C ... +85°C
Ambient temperature (operation/storage)	-25°C ... +70°C/-30°C ... +85°C
Protective circuit ⁹⁾	1, 2, 3
VDE safety class	III
Degree of protection	IP 67 and IP 68
Standards applied	EN 60947-5-2
Certifications	UL 508, C22.2 No.14-13 ^{6) 10) 11)}

- 1) At 20°C
- 2) Target: plate 20mm x 20mm
- 3) Target: plate 100mm x 100mm
- 4) Target: plate 100mm x 100mm
- 5) Of full scale value
- 6) For UL applications: for use in class 2 circuits according to NEC only
- 7) Not applicable for Type HTU418B-1000 / 4TX-M12P2 (50130241)
- 8) The ceramic material of the ultrasonic transducer contains lead zirconium titanate (PZT)
- 9) 1=short-circuit and overload protection, 2=polarity reversal protection, 3=wire break and inductive protection
- 10) These proximity switches shall be used with UL Listed Cable assemblies rated 30V, 0.5A min, in the field installation, or equivalent (categories: CYJV/CYJV7 or PVVA/PVVA7)
- 11) Ambient temperature 85°C. Use same supply source for all circuits.

Deviating Specifications for HTU418B-1000 / 4TX-M12P2

Customer-specific parameterization with the following characteristics:

- Dead zone: 350mm
- Switching point: set to 560mm on delivery
- Switching hysteresis: 25mm
- Switch-on/Switch-off delay: 1.8s
- No adjustment of the switching function (NC/NO) via the teach input

Remarks

Operate in accordance with intended use!

- ⚠ This product is not a safety sensor and is not intended as personnel protection.
- ⚠ The product may only be put into operation by competent persons.
- ⚠ Only use the product in accordance with the intended use.

Diagrams

HTU418B-400/...-M12

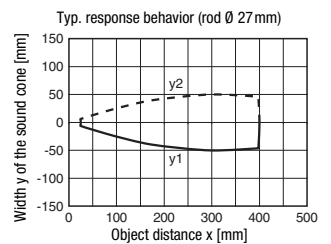
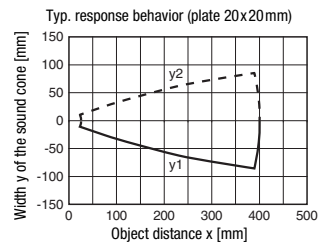

HTU418B-700/...-M12 HTU418B-1000/...-M12

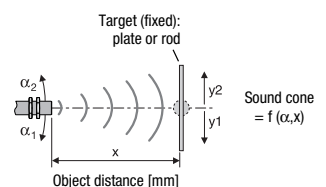
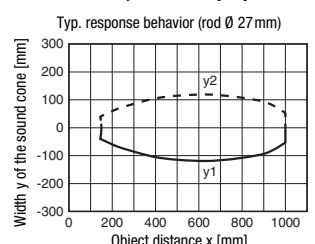
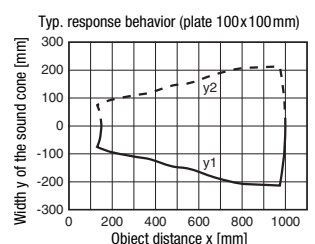
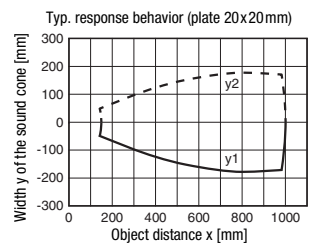

HTU418B

STANDARD ultrasonic sensors with 1 switching output

Part number code

H T U 4 1 8 B - 1 0 0 0 . X 3 / 4 T X - M 1 2 P x

Operating principle

HTU Ultrasonic sensor, scanning principle, with background suppression

DMU Ultrasonic sensor, distance measurement

Series

418B 418B Series, cylindrical M18 construction

Scanning range in mm

400 25 ... 400

700 100 ... 700

1000 150 ... 1000

Equipment (optional)

X "Advanced" design

3 Teach button on the sensor

Pin assignment of connector pin 4 / black cable wire (OUT1)

4 PNP output, NO contact preset

P PNP output, NC contact preset

L IO-Link communication or push-pull (SIO)

Pin assignment of connector pin 2 / white cable wire (Teach-IN)

T teach input

Pin assignment of connector pin 5 / gray cable wire (OUT2)

4 PNP output, NO contact preset

P PNP output, NC contact preset

V Analog voltage output 1 ... 10V

C Analog current output 4 ... 20 mA

X Connection not assigned (n. c. - not connected)

Connection technology

M12 M12 connector, 5-pin

Special devices

Px Special device version x = 1 ... 9

free Standard device

Order guide

The sensors listed here are preferred types; current information at www.leuze.com.

	Designation	Part no.	Remark
Scanning range			
25 ... 400mm	HTU418B-400/4TX-M12	50124269	
100 ... 700mm	HTU418B-700/4TX-M12	50131020	
150 ... 1000mm	HTU418B-1000/4TX-M12	50124270	
350 ... 1000mm	HTU418B-1000/4TX-M12P2	50130241	customer specific parameterization

Device functions and indicators

All sensor settings are taught via the **Teach-IN** input. Device status and switching states are indicated by a green and a yellow LED as follows:

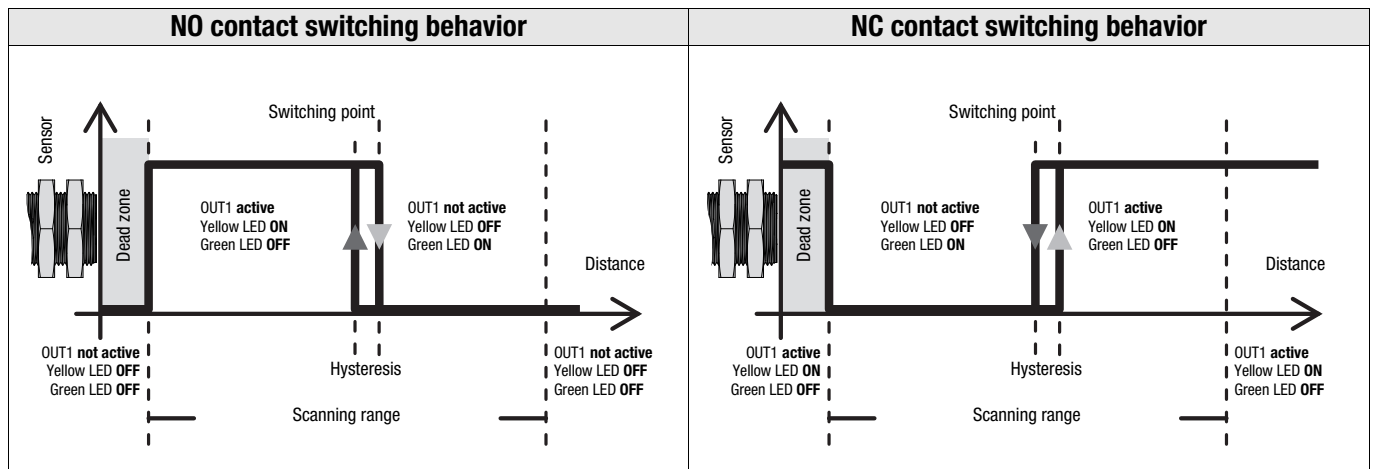

Adjusting the switching point via the teach input

The switching point of the sensor is set to 400mm, 700mm or 1000mm on delivery.

By means of a simple teach event, the switching point can be taught to an arbitrary distance within the scanning range. The Leuze **PA1/XTSX-M12** teach adapter can be used for this purpose. The adapter can also be used to easily switch the output function from NO contact to NC contact.

1-point teach
<p>1. Place object at desired switching distance.</p>
<p>2. For the adjustment of output OUT1, connect input Teach-IN to GND for 2 ... 7s (Leuze teach adapter: position "Teach-GND"). The current state of output OUT1 is frozen during the teach event.</p>
<p>3. The yellow LED flashes at 3Hz and then remains on. The current object distance has been taught as the new switching point.</p>
<p>4. Error-free teach: LED states and switching behavior according to the diagram shown above. Faulty teach (object may be too close or too far away – please note scanning range): yellow LED flashes at 5Hz until an error-free teach event is performed. The output OUT1 is inactive as long as there is a teach error.</p>

Adjusting the switching function (NC/NO) via the teach input ¹⁾

The switching function of the sensor is set to normally open (NO) on delivery.

If the switching function is changed, the switching output is changed to the opposite state (toggled).

Changeover of the switching function
<p>1. To change the switching function, connect input Teach-IN to U_B for 2 ... 7s (Leuze teach adapter: position "Teach-U_B"). The current state of output OUT1 remains frozen while the adjustment is performed.</p>
<p>2. The green and yellow LED flash alternately at 2Hz. The switching function has been reversed. The switching behavior corresponds to the diagram shown above.</p>



Notice!

Please note that **pin 2** and **pin 5** are **connected** internally. **The switching point is taught when GND is connected**, and **the output function is reversed when U_B is connected** due to the configuration of the input.

If no sensor action is desired, pin 2 and pin 5 must remain unconnected!

¹⁾ Not applicable for Type HTU418B-1000 / 4TX-M12P2 (50130241)