

Inductive Sensor Head

cable length: 10 m

INTT108

Part Number



Technical Data

Inductive Data	
Switching Distance	40 mm
Correction Factors Stainless Steel V2A/CuZn/Al	0,81/0,56/0,52
Mounting	non-flush
Mounting A/B/C/D in mm	70/120/80/25
Electrical Data	
Sensor head temperature range	-10...250 °C
Temperature Range, Plug on Sensor Head	0...50 °C
Protection Class	III
Service Life	100000 h
Mechanical Data	
Sensor head material	PTFE (FDA)
Degree of protection, sensor head	IP60
Connection	M12 × 1; 4-pin
Cable Length (L)	10 m
Outer diameter cable	5,3 mm
PWIS-free	yes

- Long service life of up to 100 000 hours
- Quickly interchangeable sensor head

The sensors consist of a sensor head and an analysis module, and are laid out for use in very hot work environments. Together with unparalleled service life in hot surroundings, large switching distances assure maximum system availability. Easily interchangeable sensor heads with numerous standard cable lengths are additionally available as separate replacement parts. The maintenance function prevents unscheduled system downtime. Thanks to unique, patented technology (DE202011001009), the sensor indicates that it should be replaced during the next scheduled maintenance before its service life expires. Furthermore, the sensor fulfills the DESINA diagnostics function as well.



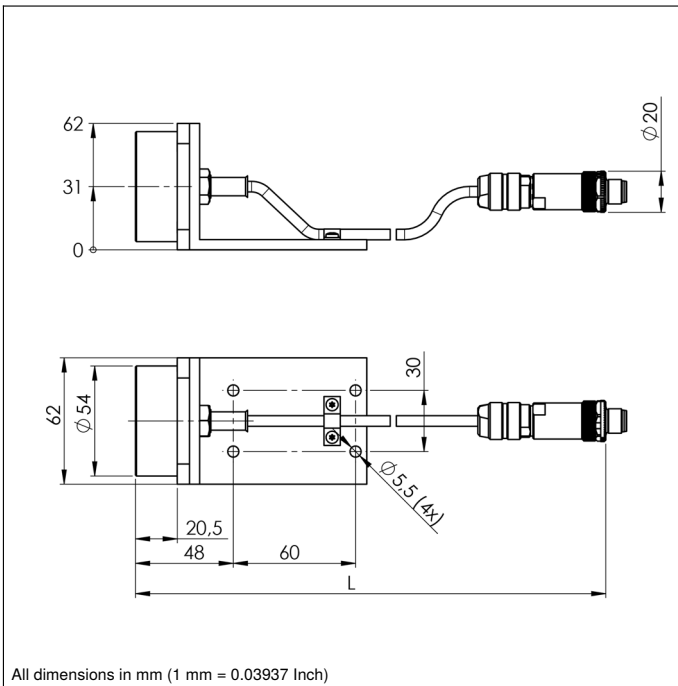

Mounting

