

Safety Light Curtain Set

Finger Protection

SEMG437



- Easy configuration via wiring
- Protection field over the entire length of the housing for an installation without protrusion
- Quick alignment through visible red light
- Slim design for easy integration

These safety light curtains confidently solve all basic tasks. The basic function protection mode, restart inhibit and protection monitoring are standard and can be easily configured. The protective field always extends up to the end of the housing without protrusion. As a result, protection is easily provided even in confined installation conditions. The adequate mounting angle ZEMX001 is included in the delivery.

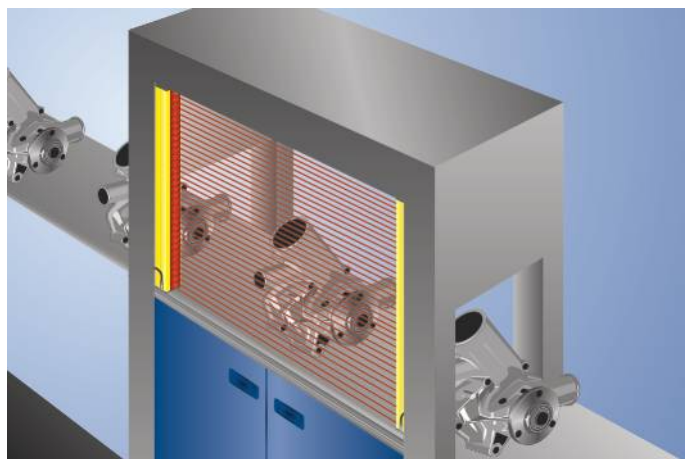

Optical Data	
Range	0,25...6 m
Housing Length (L)	1060 mm
Safety Field Height (SFH)	1061 mm
Resolution	14 mm
Light Source	Red Light
Wavelength	630 nm
Max. Ambient Light	10000 Lux
Opening Angle	± 2,5 °
Electrical Data	
Sensor Type	Set
Supply Voltage	19,2...28,8 V DC
Response Time	16,5 ms
Temperature Range	-25...55 °C
Storage temperature	-25...60 °C
Number of safety outputs (OSSDs)	2
Safety Output Voltage Drop	< 2,3 V
PNP Safety Output/Switching Current	300 mA
Number of Signal Outputs	1
Signal Output Voltage Drop	< 2,5 V
Signal Output/Switching Current	100 mA
Short Circuit and Overload Protection	yes
Reverse Polarity Protection	yes
Protection Class	III
Mechanical Data	
Housing Material	Aluminum
Disc Material	Polycarbonate
Degree of Protection	IP65/IP67
Connection	M12 × 1
Cable Length	300 mm
Safety-relevant Data	
ESPE Type (EN 61496)	4
Safety Category (EN ISO 13849-1)	4
Performance Level (EN ISO 13849-1)	PL e
PFHD	1,60 × E-8 1/h
Mission Time TM (EN ISO 13849-1)	20 a
Safety Integrity Level (EN 61508)	SIL3
Safety Integrity Level (EN 62061)	SILCL3
Function	
Finger Protection	yes
Scope of functions	Basic function
Scope of delivery	Mounting ZEMX001
Scope of delivery (Emitter; Receiver)	SEMG537; SEMG637
Connection Diagram No.	361 362
Control Panel No.	SR4 SR5
Suitable Connection Equipment No.	35 89
Suitable Mounting Technology No.	701 790 810 820

Complementary Products

Path-Folding Mirror Z2UG003
Protection column with deflection mirror Z2SU002
Protection Column with Path-Folding Mirror SZ000EU125NN01
Protection Column with Protective Screen SZ000EG125NN01
Protection column with protective screen Z2SS002
Safety Relay SG4-00VA000R2, SR4B3B01S, SR4D3B01S
Software

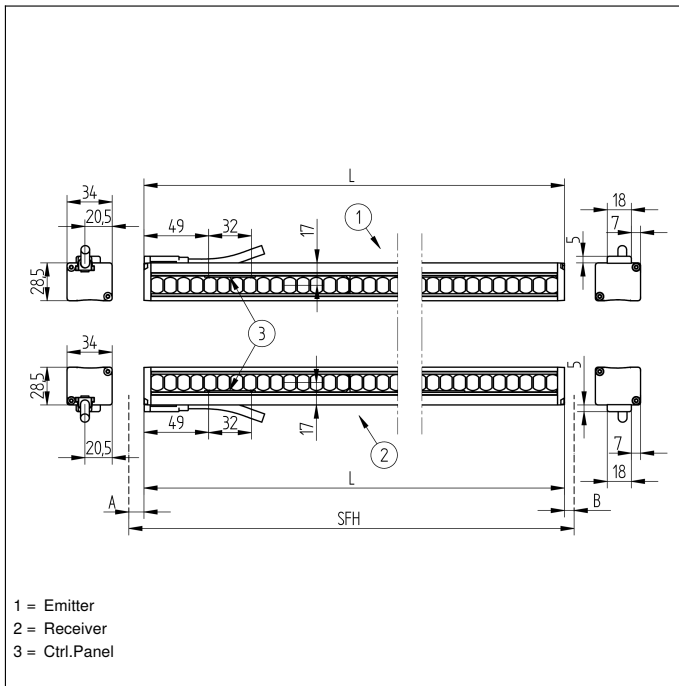

Ctrl. Panel

SR5

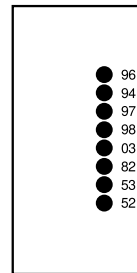

SR4

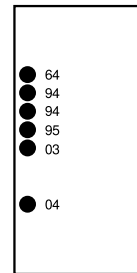

- 03 = Error Indicator
- 04 = Function Indicator
- 52 = OSSD ON
- 53 = OSSD OFF
- 64 = Diagnosis/Test
- 82 = Acknowledgement Request
- 94 = Diagnosis
- 95 = Diagnosis/Large Detection Range
- 96 = Diagnosis/Signal weak
- 97 = Diagnosis/Contactor Monitoring
- 98 = Diagnosis/Synchronization

