

# JR Encapsulation Installation Manual



## APPLICATION

JR luminaires are designed for use indoors, outdoors, wet locations, and areas containing moisture, dirt, corrosion, vibration, and rough usage. The JR luminaire is also certified for use on marine vessels inside, outside and in other severely wet saltwater environments.

JR luminaires are suitable for use in the following areas as defined by the National Electrical Code (NEC) and the Canadian Electrical Code (CEC):

### Labtest Certification

File Numbers:

Nemalux General Location: LC22294-1  
 Nemalux Hazardous Location: LC22294-1

Standards that apply to all models:

UL 1598, UL 1598A and UL 8750;  
 CSA C22.2 No. 250.0 and CSA C22.2 No. 250.13

Housing:

Copper-free high pressure die-cast aluminum housing, glass or polycarbonate protective lens, stainless steel fasteners

Input Voltage:

Suffix - AC: 120-277 VAC | HV: 347 VAC

Ambient Temperature Range:

-40°C to +60°C

Connections:

Flying lead. Standard 10ft 18/3 SOOW  
 Black: Line | White: Neutral/Line 2 | Green: Ground  
*Optional: Violet (Purple): 0-10V Dimming (+) | Grey: 0-10V Dimming (-)*  
 For connections use wire rated to a minimum of 90°C. Class 1 Wiring only.  
 All supply field wiring must be rated 300V minimum for luminaires with suffix AC, 600V minimum for luminaires with suffix HV.

Ingress Protection:

IP68 | Continuous Submersion 25ft | Suitable for Wet Locations. | Marine Outside Type (Salt Water)



### WARNING / ATTENTION

To avoid the risk of fire, explosion, or electric shock, this product should be installed, inspected, and maintained by a qualified electrician only, in accordance with all applicable electrical codes.

Éviter tout risque d'incendie, d'explosion ou d'électrocution, ce produit doit être installé, inspecté et entretenu par un électricien qualifié uniquement, conformément à tous codes électriques applicables.



### WARNING / ATTENTION

To reduce the risk of electric shock, disconnect the luminaire from the supply circuit before opening for installation and servicing. Keep tightly closed when in operation.

Pour réduire le risque de choc électrique, débranchez le luminaire du circuit d'alimentation avant l'ouverture pour l'installation et entretien. Gardez hermétiquement fermé pendant le fonctionnement.



### WARNING ATTENTION

Potential Electrostatic Charging Hazard  
 Risque potentiel de charge électrostatique

Avoid electrostatic discharge:

- Clean exterior lens surface with damp cloth only
- Éviter les décharges électrostatiques: nettoyer la surface extérieure de la lentille uniquement avec un chiffon humide

## JR-SM – SURFACE/CEILING MOUNT INSTALLATION (Ordered Separately)

Refer to alternate instructions if using Hook or Yoke Mount

This JR-SM kit is intended for use with LC Listed JR luminaire as marked on the luminaire nameplate.

### Accessory Package Contents

JR-SM	QTY	PART NAME
	2	SURFACE/SUSPENSION MOUNT BRACKET
	4	M6 X 12mm HEX HEAD CAP SCREW
	4	M6 FLAT WASHER

## INSTALLATION STEPS

### STEP 1.

Inspect shipping package and contents to ensure no damage has occurred during shipping.

### STEP 2.

Install Surface/Suspension Mount Brackets using the 4x M6 hex cap bracket mounting screws. See diagram for orientation of brackets. Torque M6 bolts to 5 Nm (45 in-lbs).

### STEP 3.

A) For surface mounting configuration, mount luminaire in desired locations using 4x 1/4-20 OR 4x M6 fasteners and washers (Not provided).



Step 1-3

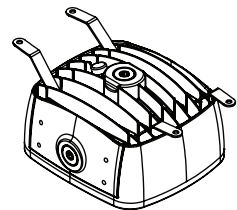
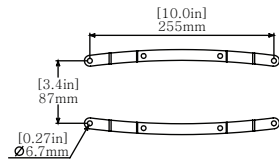
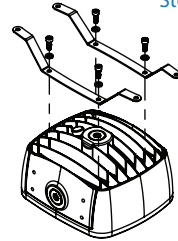

## JR-SM – SURFACE/CEILING MOUNT INSTALLATION CONT.

### INSTALLATION STEPS CONT.

#### STEP 4:

Terminate the supply end in a suitable Listed junction box using a suitable Listed fitting approved for installation location as required.

All field wiring supply conductors shall be rated 90°C minimum and rated for supply voltage (300V AC Models, 600V HV models).



Black: Line 1 (L1) | White: Neutral/Line 2 | Green: Ground  
Dimming (Flying lead cable), Class 1 Wiring:



Black: Line | White: Neutral/Line 2 | Green: Ground  
Red: Dimming (+) | Orange: Dimming

- LED Drivers will source a combined maximum of 200µA for control needs
- 0-10V Controller must sink current from LED driver 0-10V control connections

#### STEP 5:

Connect the lead wires from the cord to the field supply wiring inside the outlet box. The field wiring terminations are to be made following acceptable practices as outlined by the NEC / CEC

#### STEP 6:

Energize luminaire.

## JR-YK – HIGH VIBRATION YOKE INSTALLATION (Ordered Separately)

Refer to alternate instructions if using Surface or Hook Mount

This JR-YK kit is intended for use with LC Listed JR luminaire as marked on the luminaire nameplate.

### Accessory Package Contents

JR-YK	QTY	PART NAME
	1	JR HIGH VIBRATION YOKE
	2	CHEEK PLATE
	8	M6 x 1 x 25mm SOCKET FLAT HEAD CAP SCREW
	4	M6 FLAT WASHER
	4	M6 x 1 x 16mm SOCKET HEAD CAP SCREW



## INSTALLATION STEPS

### STEP 1.

Inspect shipping package and contents to ensure no damage has occurred during shipping.

### STEP 2.

Mount JR high vibration yoke to mounting surface using a minimum of 4x ¼-20 or M6 fasteners (not provided).

### STEP 3.

Mount JR Cheek Plates to sides of JR luminaire using 4x M6 flat head cap screws per side. Thread one cheek plate over installed wiring during assembly. Torque fasteners to 5 Nm (45 in-lbs).

### STEP 5.

Thread installed wiring through opening in JR high vibration yoke mount and install JR luminaire into yoke. The raised circular bosses on the JR cheek plates should register inside of the large circular holes on the JR high vibration yoke mount arms. Rotate luminaire to aim in the desired direction and fasten in place using 2x M6 socket head cap screws and flat washers per side. Torque fasteners to 5 Nm (45 in-lbs).

### STEP 6.

Resume installation instructions provided with luminaire (STEP 4 on PAGE 3).

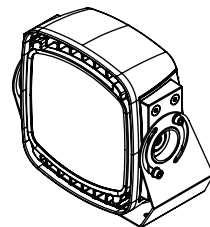
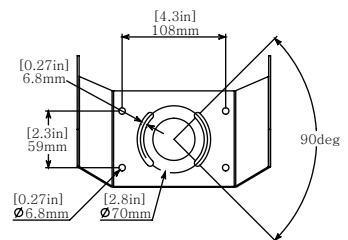
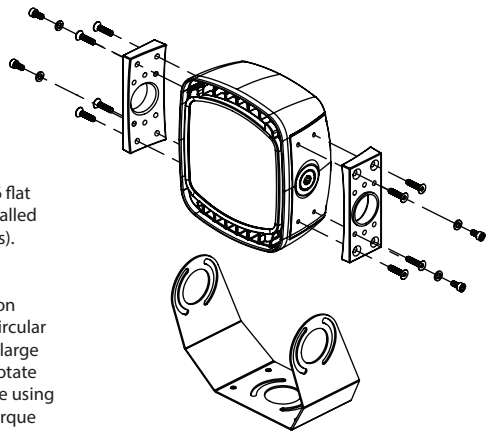

## JR-YM – YOKE MOUNT INSTALLATION (Ordered Separately)

Refer to alternate instructions if using Surface or Hook Mount

This JR-YM kit is intended for use with LC Listed JR luminaire as marked on the luminaire nameplate.

### Accessory Package Contents

JR-YM	QTY	PART NAME
	1	YOKE MOUNT A
	1	YOKE MOUNT B
	1	CHEEK PLATE
	4	1/4-20 HEX NUT
	4	1/4" FLAT WASHER
	4	1/4-20 x 0.5in CARRIAGE BOLT
	4	M6 x 25mm HEX HEAD CAP SCREW

### INSTALLATION STEPS

#### STEP 1.

Inspect shipping package and contents to ensure no damage has occurred during shipping.

#### STEP 2.

Loosely assemble Yoke mount with carriage bolts on inside and washers and nuts on the outside.

*NOTE: Depending on which mounting hole is used in the curved slot, the luminaire may be configured for an upward or downward adjustable swing.*

#### STEP 3.

Thread installed wiring through openings in yoke mount cheek plate and yoke mount bracket. Mount yoke assembly to luminaire using 4x M6 Socket Head Cap Screws and Washers (Provided). Torque fasteners to 5 Nm (45 in-lbs).

#### STEP 4.

Mount luminaire assembly to desired location using 4x 1/4-20 OR M6 Screws or Bolts (Not Provided).

#### STEP 5.

Adjust and aim luminaire to desired position. Torque hardware nuts to 9 N-m (80 in-lbs).

#### STEP 6.

Resume installation instructions provided with luminaire (STEP 4 on PAGE 3).

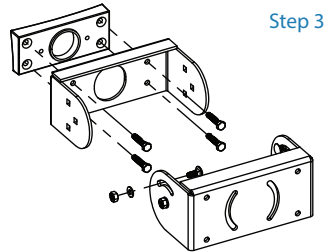

Step 3

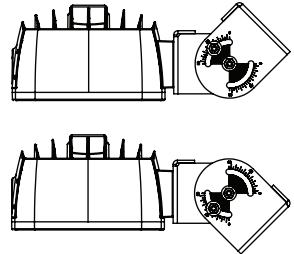

Step 5

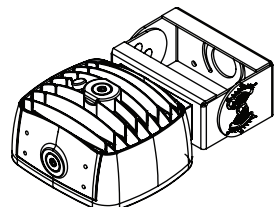
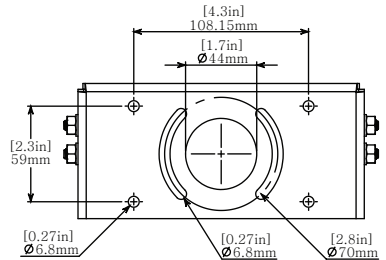

## JR-HK – HOOK PENDANT INSTALLATION (Ordered Separately)

*Refer to alternate instructions if using Surface or Yoke Mount*

This JR-HK kit is intended for use with LC Listed JR luminaire as marked on the luminaire nameplate.

### Accessory Package Contents

JR-HK	QTY	PART NAME
	1	PENDANT HOOK ASSEMBLY
	1	ANTI-ROTATION ASSEMBLY

### INSTALLATION STEPS

#### STEP 1.

Inspect shipping package and contents to ensure no damage has occurred during shipping.

#### STEP 2.

It is recommended to install Secondary Safety Cable by looping appropriate steel cable or chain through the outer band of the unit and fastening a closed loop. Secondary safety hardware must be rated for a minimum of 50lbs. Secondary safety cables made from stainless steel aircraft cable are available upon request.

#### STEP 3.

Latch hook onto eye-bolt or other fixed mounting loop. Mounting point must be rated for a minimum of 50lbs.

#### STEP 4.

Install remaining loop of secondary safety chain or steel cable to suitable mounting location and fasten securely.

#### STEP 5.

Resume installation instructions provided with luminaire (STEP 4 on PAGE 3).

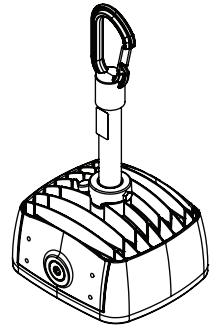

This kit contains Anti-Rotation-Lock